

LEGEND

Rock Retaining Wall shown as:-	
Sleeper Retaining Wall shown as:-	
Landscape Retaining Wall shown as:-	
Sewer line	
Sewer Manhole	
Roofwater Drainage line and Catch Pit	
Stormwater Drainage Line	
Stormwater Manhole	
Stormwater Pit	
Water Main	
Water Conduit	
Water Service Point of Entry	
Underground Electricity, Street Light, Electricity Pillar & NBN	
Developer Fencing	
Concrete Pathway	
Zero Setback Building Line	
Landscape Street Tree	
Indicative Building Envelope	
Bin Pads	
Proposed Services Easement	
Indicative Parking Access Location	

ADDITIONAL NOTES:

Allotments used as Multiple Residential Allotments in accordance with the approved Plan of Development may have a reduced primary road setback to 3.0metres as noted on the Plan of Development Table.

Compaction of any fill material placed on this site shall be completed to level one inspection and testing services in accordance with AS3798-2007.

Location of sewer, roofwater, stormwater, water reticulation and electricity lines, manholes and pits are those shown on engineering design drawings, supplied by Peak Urban and may differ from the as-constructed location.

Plan of Development information Supplied by RPS Group PLC.

Copyright © Veris Australia Pty Ltd
1st November 2022.

Plot Date: 04 Nov, 2022
 Computer File Ref: 430109_S3D-SP-A.dwg

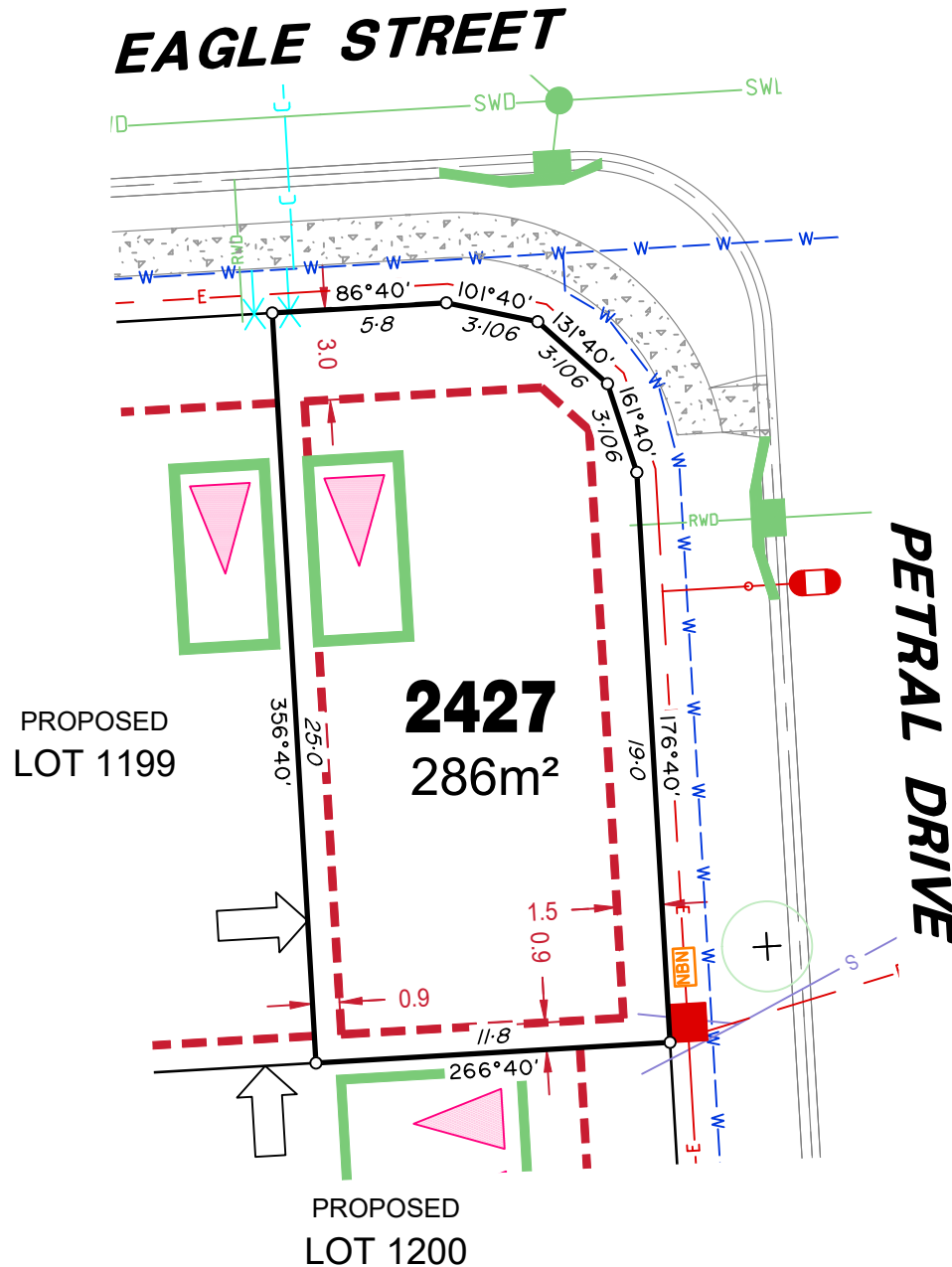

LEGEND

Rock Retaining Wall shown as:-	
Sleeper Retaining Wall shown as:-	
Landscape Retaining Wall shown as:-	
Sewer line	
Sewer Manhole	
Roofwater Drainage line and Catch Pit	
Stormwater Drainage Line	
Stormwater Manhole	
Stormwater Pit	
Water Main	
Water Conduit	
Water Service Point of Entry	
Underground Electricity, Street Light, Electricity Pillar & NBN	
Developer Fencing	
Concrete Pathway	
Zero Setback Building Line	
Indicative Building Envelope	
Bin Pads	
Proposed Services Easement	
Indicative Parking Access Location	
Landscape Street Tree	

ADDITIONAL NOTES:

Allotments used as Multiple Residential Allotments in accordance with the approved Plan of Development may have a reduced primary road setback to 3.0metres as noted on the Plan of Development Table.

Compaction of any fill material placed on this site shall be completed to level one inspection and testing services in accordance with AS3798-2007.

Location of sewer, roofwater, stormwater, water reticulation and electricity lines, manholes and pits are those shown on engineering design drawings, supplied by Colliers and may differ from the as-constructed location.

Plan of Development information Supplied by RPS Group PLC.

Copyright © Veris Australia Pty Ltd
May 2023.

Plot Date: 19 May, 2023
Computer File Ref: 430109_St3D-SP-A.dwg



PETRAL DRIVE

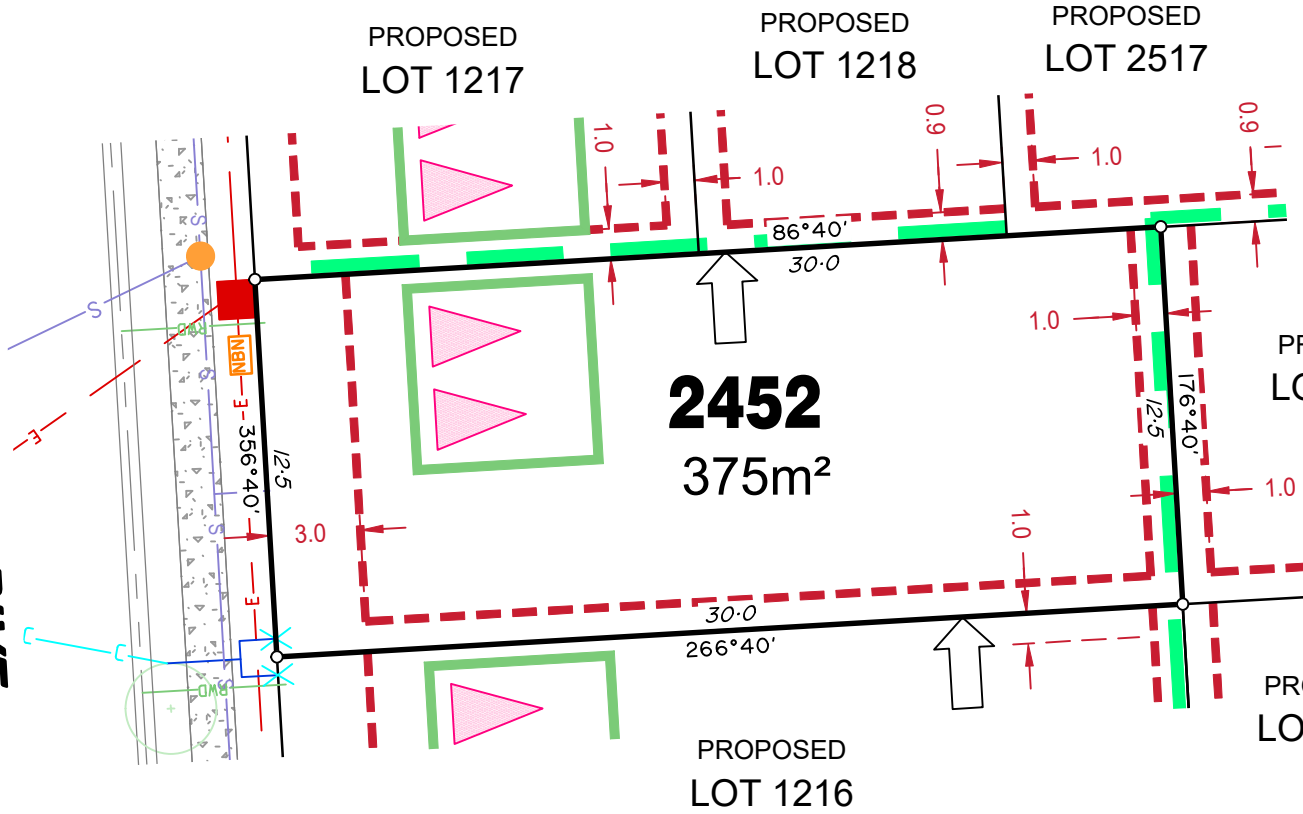

LEGEND

- Rock Retaining Wall shown as:-
- Sleeper Retaining Wall shown as:-
- Landscape Retaining Wall shown as:-
- Sewer line
- Sewer Manhole
- Roofwater Drainage line and Catch Pit
- Stormwater Drainage Line
- Stormwater Manhole
- Stormwater Pit
- Water Main
- Water Conduit
- Water Service Point of Entry
- Underground Electricity, Street Light, Electricity Pillar & NBN
- Developer Fencing
- Concrete Pathway
- Landscape Street Tree
- Proposed Zero Setback Building Line
- Indicative Building Envelope
- Bin Pads
- Proposed Services Easement
- Indicative Parking Access Location

ADDITIONAL NOTES:

Allotments used as Multiple Residential Allotments in accordance with the approved Plan of Development may have a reduced primary road setback to 3.0metres as noted on the Plan of Development Table.

Compaction of any fill material placed on this site shall be completed to level one inspection and testing services in accordance with AS3798-2007.

Location of sewer, roofwater, stormwater, water reticulation and electricity lines, manholes and pits are those shown on engineering design drawings, supplied by Colliers and may differ from the as-constructed location.

Plan of Development information Supplied by RPS Group PLC.

Copyright © Veris Australia Pty Ltd
May 2023.

Plot Date: 12 May, 2023
 Computer File Ref: 430109_St3D-SP-A.dwg

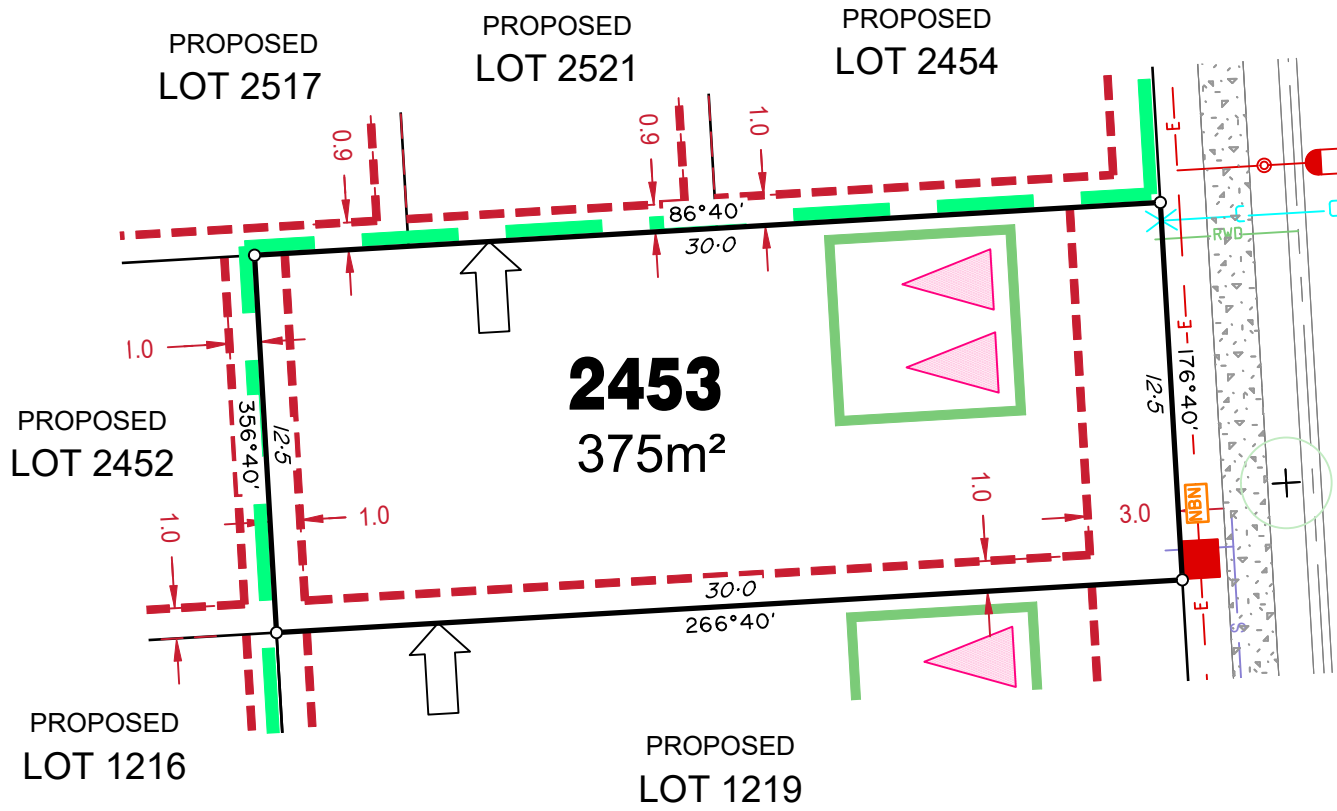

LEGEND

Rock Retaining Wall shown as:-	
Sleeper Retaining Wall shown as:-	
Landscape Retaining Wall shown as:-	
Sewer line	
Sewer Manhole	
Roofwater Drainage line and Catch Pit	
Stormwater Drainage Line	
Stormwater Manhole	
Stormwater Pit	
Water Main	
Water Conduit	
Water Service Point of Entry	
Underground Electricity, Street Light, Electricity Pillar & NBN	
Developer Fencing	
Concrete Pathway	
Zero Setback Building Line	
Indicative Building Envelope	
Bin Pads	
Proposed Services Easement	
Indicative Parking Access Location	
Landscape Street Tree	

COLLEGE DRIVE

ADDITIONAL NOTES:

Allotments used as Multiple Residential Allotments in accordance with the approved Plan of Development may have a reduced primary road setback to 3.0metres as noted on the Plan of Development Table.

Compaction of any fill material placed on this site shall be completed to level one inspection and testing services in accordance with AS3798-2007.

Location of sewer, roofwater, stormwater, water reticulation and electricity lines, manholes and pits are those shown on engineering design drawings, supplied by Colliers and may differ from the as-constructed location.

Plan of Development information Supplied by RPS Group PLC.

Copyright © Veris Australia Pty Ltd
May 2023.

Plot Date: 19 May, 2023
Computer File Ref: 430109_S3D-SP-A.dwg

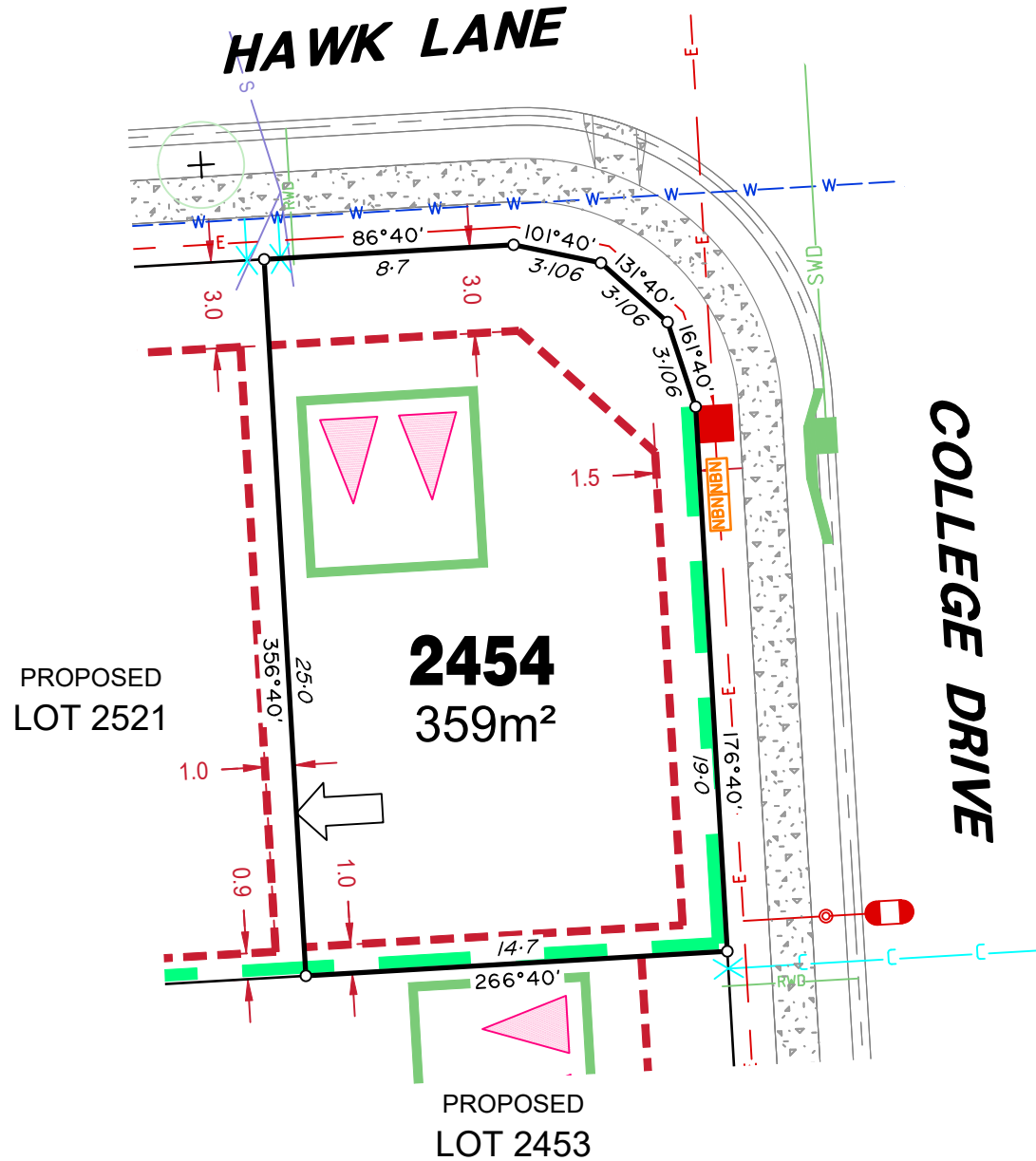

LEGEND

Rock Retaining Wall shown as:-	
Sleeper Retaining Wall shown as:-	
Landscape Retaining Wall shown as:-	
Sewer line	
Sewer Manhole	
Roofwater Drainage line and Catch Pit	
Stormwater Drainage Line	
Stormwater Manhole	
Stormwater Pit	
Water Main	
Water Conduit	
Water Service Point of Entry	
Underground Electricity, Street Light, Electricity Pillar & NBN	
Developer Fencing	
Concrete Pathway	
Zero Setback Building Line	
Indicative Building Envelope	
Bin Pads	
Proposed Services Easement	
Indicative Parking Access Location	
Landscape Street Tree	

ADDITIONAL NOTES:

Allotments used as Multiple Residential Allotments in accordance with the approved Plan of Development may have a reduced primary road setback to 3.0metres as noted on the Plan of Development Table.

Compaction of any fill material placed on this site shall be completed to level one inspection and testing services in accordance with AS3798-2007.

Location of sewer, roofwater, stormwater, water reticulation and electricity lines, manholes and pits are those shown on engineering design drawings, supplied by Colliers and may differ from the as-constructed location.

Plan of Development information Supplied by RPS Group PLC.

Copyright © Veris Australia Pty Ltd
May 2023.

Plot Date: 19 May, 2023
 Computer File Ref: 430109_S3D-SP-A.dwg



PROPOSED LOT 1193

PROPOSED LOT 2471

PROPOSED LOT 1203

2472
318m²

PETRAL DRIVE

ROAD

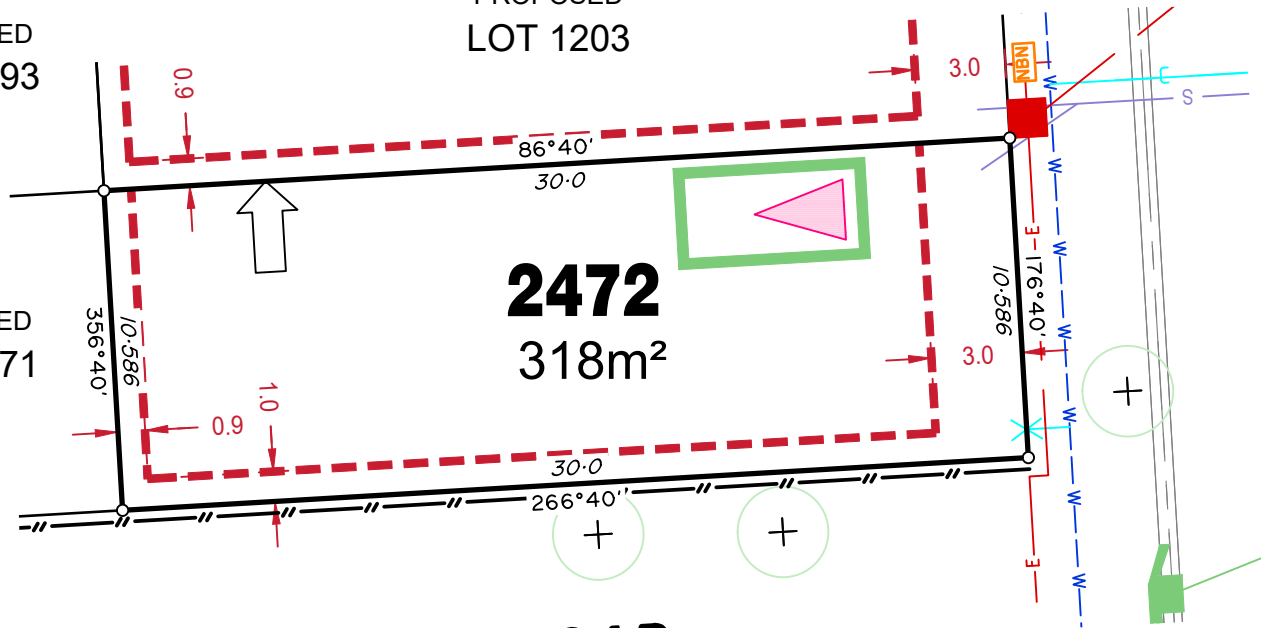

LEGEND

Rock Retaining Wall shown as:-	
Sleeper Retaining Wall shown as:-	
Landscape Retaining Wall shown as:-	
Sewer line	
Sewer Manhole	
Roofwater Drainage line and Catch Pit	
Stormwater Drainage Line	
Stormwater Manhole	
Stormwater Pit	
Water Main	
Water Conduit	
Water Service Point of Entry	
Underground Electricity, Street Light, Electricity Pillar & NBN	
Developer Fencing	
Concrete Pathway	
Zero Setback Building Line	
Indicative Building Envelope	
Bin Pads	
Proposed Services Easement	
Indicative Parking Access Location	
Landscape Street Tree	

ADDITIONAL NOTES:

Allotments used as Multiple Residential Allotments in accordance with the approved Plan of Development may have a reduced primary road setback to 3.0metres as noted on the Plan of Development Table.

Compaction of any fill material placed on this site shall be completed to level one inspection and testing services in accordance with AS3798-2007.

Location of sewer, roofwater, stormwater, water reticulation and electricity lines, manholes and pits are those shown on engineering design drawings, supplied by Colliers and may differ from the as-constructed location.

Plan of Development information Supplied by RPS Group PLC.

Copyright © Veris Australia Pty Ltd
May 2023.

Plot Date: 19 May, 2023
Computer File Ref: 430109_S3D-SP-A.dwg

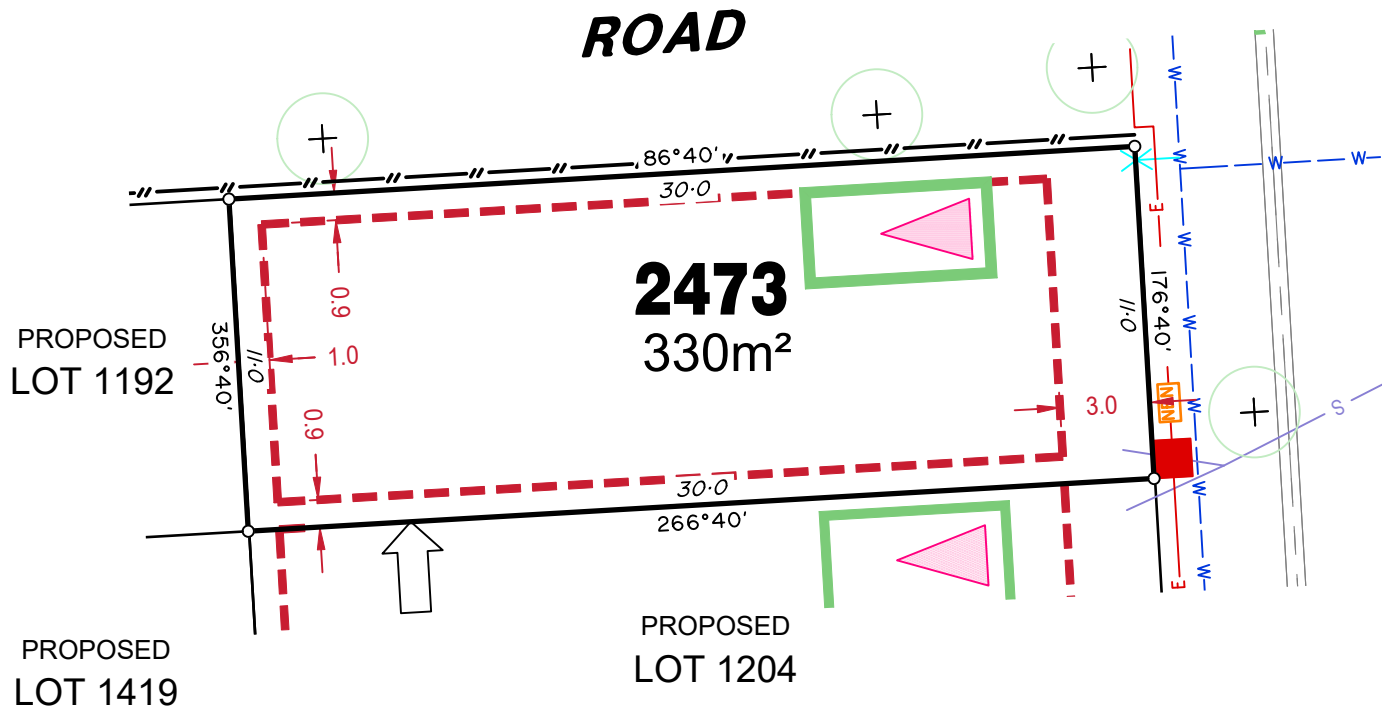

LEGEND

Rock Retaining Wall shown as:-	
Sleeper Retaining Wall shown as:-	
Landscape Retaining Wall shown as:-	
Sewer line	
Sewer Manhole	
Roofwater Drainage line and Catch Pit	
Stormwater Drainage Line	
Stormwater Manhole	
Stormwater Pit	
Water Main	
Water Conduit	
Water Service Point of Entry	
Underground Electricity, Street Light, Electricity Pillar & NBN	
Developer Fencing	
Concrete Pathway	
Zero Setback Building Line	
Indicative Building Envelope	
Bin Pads	
Proposed Services Easement	
Indicative Parking Access Location	
Landscape Street Tree	

ADDITIONAL NOTES:

Allotments used as Multiple Residential Allotments in accordance with the approved Plan of Development may have a reduced primary road setback to 3.0metres as noted on the Plan of Development Table.

Compaction of any fill material placed on this site shall be completed to level one inspection and testing services in accordance with AS3798-2007.

Location of sewer, roofwater, stormwater, water reticulation and electricity lines, manholes and pits are those shown on engineering design drawings, supplied by Colliers and may differ from the as-constructed location.

Plan of Development information Supplied by RPS Group PLC.

Copyright © Veris Australia Pty Ltd
May 2023.

Plot Date: 19 May, 2023
 Computer File Ref: 430109_S3D-SP-A.dwg



HAWK LANE

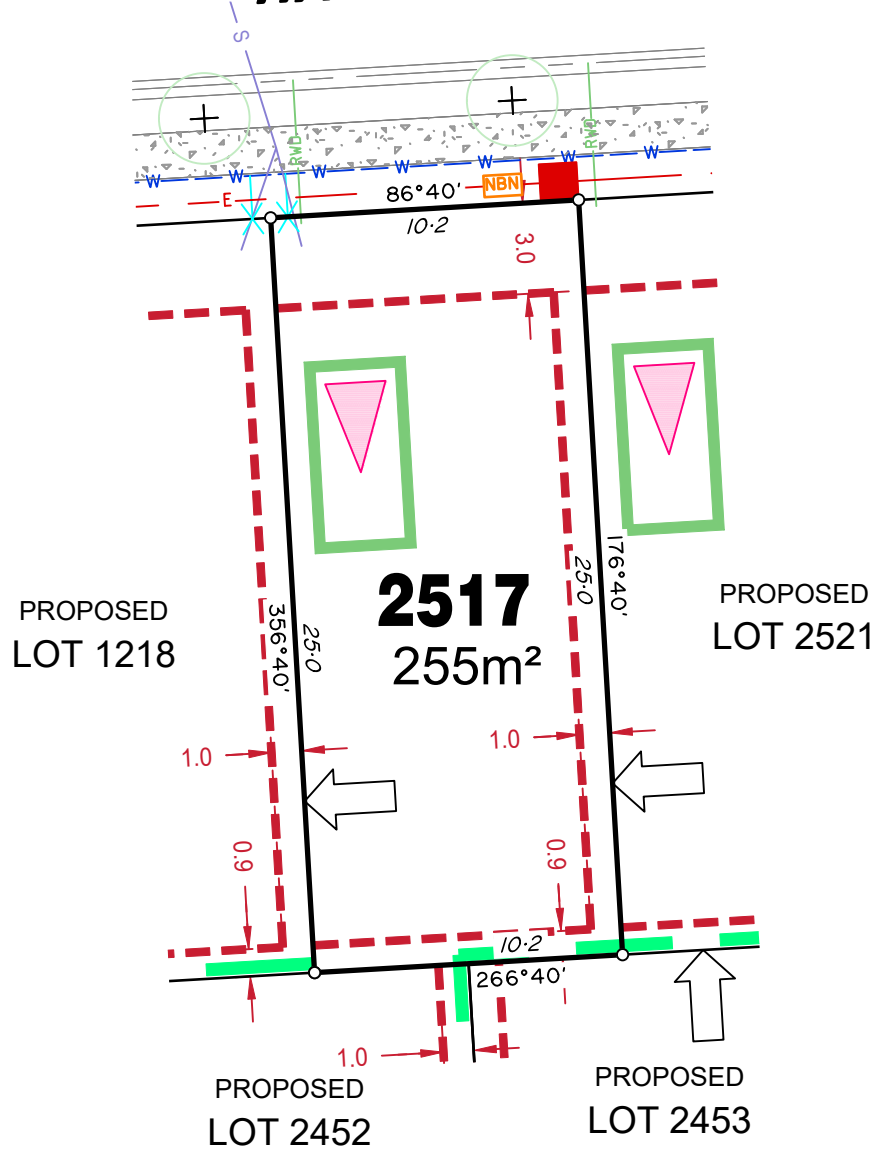

Rock Retaining Wall shown as:-	
Sleeper Retaining Wall shown as:-	
Landscape Retaining Wall shown as:-	
Sewer line	
Sewer Manhole	
Roofwater Drainage line and Catch Pit	
Stormwater Drainage Line	
Stormwater Manhole	
Stormwater Pit	
Water Main	
Water Conduit	
Water Service Point of Entry	
Underground Electricity, Street Light, Electricity Pillar & NBN	
Developer Fencing	
Concrete Pathway	
Landscaping Street Tree	
Zero Setback Building Line	
Indicative Building Envelope	
Bin Pads	
Proposed Services Easement	
Indicative Parking Access Location	

ADDITIONAL NOTES:

Allotments used as Multiple Residential Allotments in accordance with the approved Plan of Development may have a reduced primary road setback to 3.0metres as noted on the Plan of Development Table.

Compaction of any fill material placed on this site shall be completed to level one inspection and testing services in accordance with AS3798-2007.

Location of sewer, roofwater, stormwater, water reticulation and electricity lines, manholes and pits are those shown on engineering design drawings, supplied by Colliers and may differ from the as-constructed location.

Plan of Development information Supplied by RPS Group PLC.

Copyright © Veris Australia Pty Ltd
May 2023.

Plot Date: 19 May, 2023
 Computer File Ref: 430109_St3D-SP-A.dwg



HAWK LANE

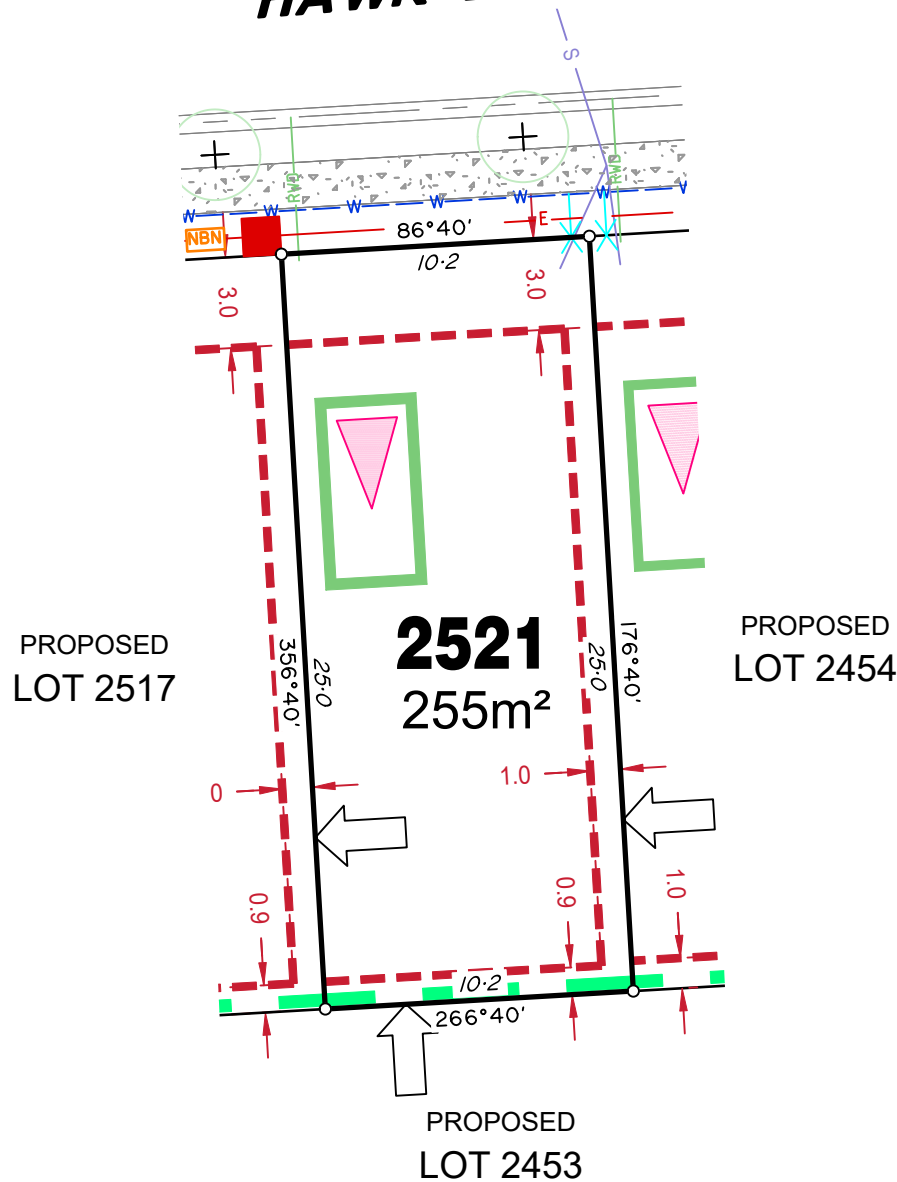

LEGEND

Rock Retaining Wall shown as:-	
Sleeper Retaining Wall shown as:-	
Landscape Retaining Wall shown as:-	
Sewer line	
Sewer Manhole	
Roofwater Drainage line and Catch Pit	
Stormwater Drainage Line	
Stormwater Manhole	
Stormwater Pit	
Water Main	
Water Conduit	
Water Service Point of Entry	
Underground Electricity, Street Light, Electricity Pillar & NBN	
Developer Fencing	
Concrete Pathway	
Landscape Street Tree	
Zero Setback Building Line	
Indicative Building Envelope	
Bin Pads	
Proposed Services Easement	
Indicative Parking Access Location	

ADDITIONAL NOTES:

Allotments used as Multiple Residential Allotments in accordance with the approved Plan of Development may have a reduced primary road setback to 3.0metres as noted on the Plan of Development Table.

Compaction of any fill material placed on this site shall be completed to level one inspection and testing services in accordance with AS3798-2007.

Location of sewer, roofwater, stormwater, water reticulation and electricity lines, manholes and pits are those shown on engineering design drawings, supplied by Colliers and may differ from the as-constructed location.

Plan of Development information Supplied by RPS Group PLC.

Copyright © Veris Australia Pty Ltd
May 2023.

Plot Date: 19 May, 2023
 Computer File Ref: 430109_St3D-SP-A.dwg



EAGLE STREET

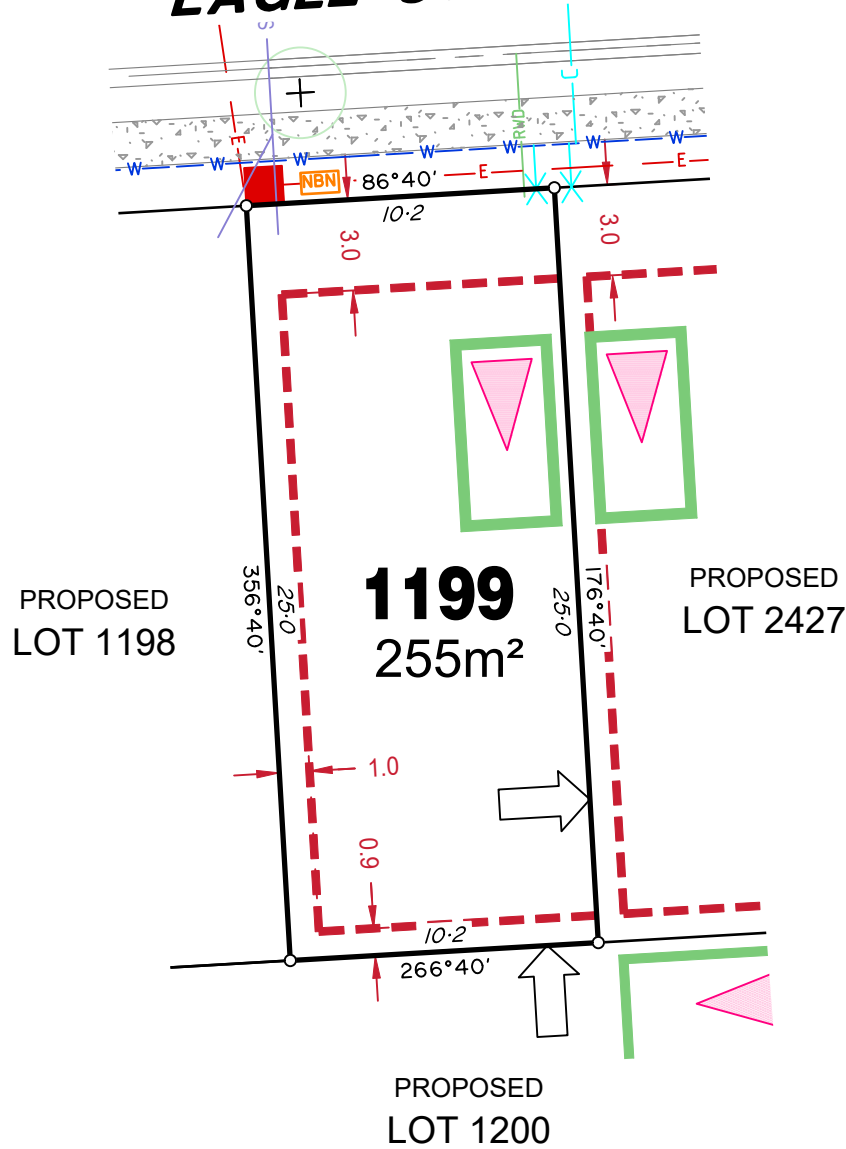

LEGEND

Rock Retaining Wall shown as:-	
Sleeper Retaining Wall shown as:-	
Landscape Retaining Wall shown as:-	
Sewer line	
Sewer Manhole	
Roofwater Drainage line and Catch Pit	
Stormwater Drainage Line	
Stormwater Manhole	
Stormwater Pit	
Water Main	
Water Conduit	
Water Service Point of Entry	
Underground Electricity, Street Light, Electricity Pillar & NBN	
Developer Fencing	
Concrete Pathway	
Zero Setback Building Line	
Landscape Street Tree	
Indicative Building Envelope	
Bin Pads	
Proposed Services Easement	
Indicative Parking Access Location	

ADDITIONAL NOTES:

Allotments used as Multiple Residential Allotments in accordance with the approved Plan of Development may have a reduced primary road setback to 3.0metres as noted on the Plan of Development Table.

Compaction of any fill material placed on this site shall be completed to level one inspection and testing services in accordance with AS3798-2007.

Location of sewer, roofwater, stormwater, water reticulation and electricity lines, manholes and pits are those shown on engineering design drawings, supplied by Colliers and may differ from the as-constructed location.

Plan of Development information Supplied by RPS Group PLC.

Copyright © Veris Australia Pty Ltd
May 2023.

Plot Date: 19 May, 2023
 Computer File Ref: 430109_St3D-SP-B.dwg

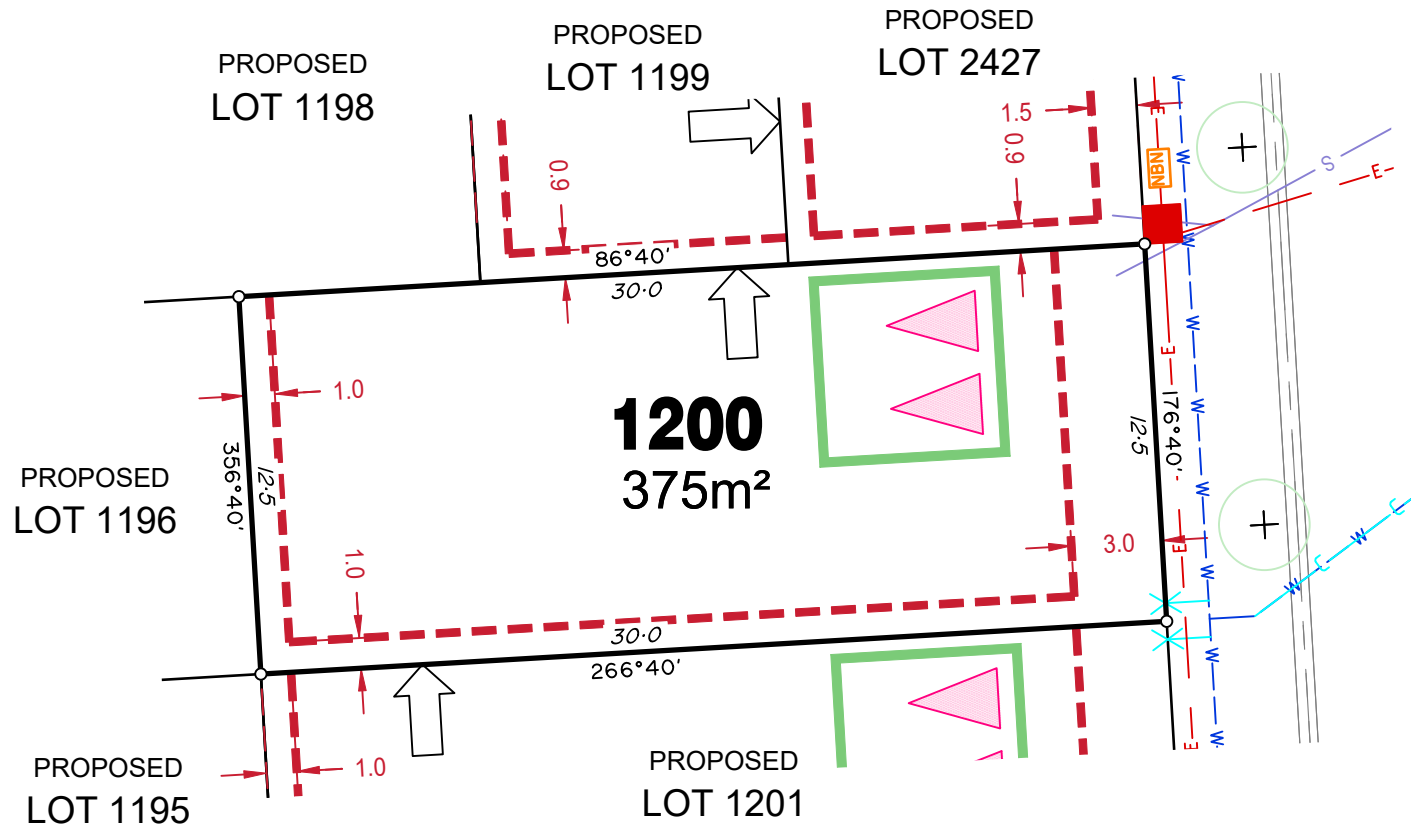

LEGEND

- Rock Retaining Wall shown as:-
- Sleeper Retaining Wall shown as:-
- Landscape Retaining Wall shown as:-
- Sewer line
- Sewer Manhole
- Roofwater Drainage line and Catch Pit
- Stormwater Drainage Line
- Stormwater Manhole
- Stormwater Pit
- Water Main
- Water Conduit
- Water Service Point of Entry
- Underground Electricity, Street Light, Electricity Pillar & NBN
- Developer Fencing
- Concrete Pathway
- Landscape Street Tree
- Zero Setback Building Line
- Indicative Building Envelope
- Bin Pads
- Proposed Services Easement
- Indicative Parking Access Location

PETRAL DRIVE

ADDITIONAL NOTES:

Allotments used as Multiple Residential Allotments in accordance with the approved Plan of Development may have a reduced primary road setback to 3.0metres as noted on the Plan of Development Table.

Compaction of any fill material placed on this site shall be completed to level one inspection and testing services in accordance with AS3798-2007.

Location of sewer, roofwater, stormwater, water reticulation and electricity lines, manholes and pits are those shown on engineering design drawings, supplied by Colliers and may differ from the as-constructed location.

Plan of Development information Supplied by RPS Group PLC.

Copyright © Veris Australia Pty Ltd
May 2023.

Plot Date: 19 May, 2023
 Computer File Ref: 430109_St3D-SP-B.dwg

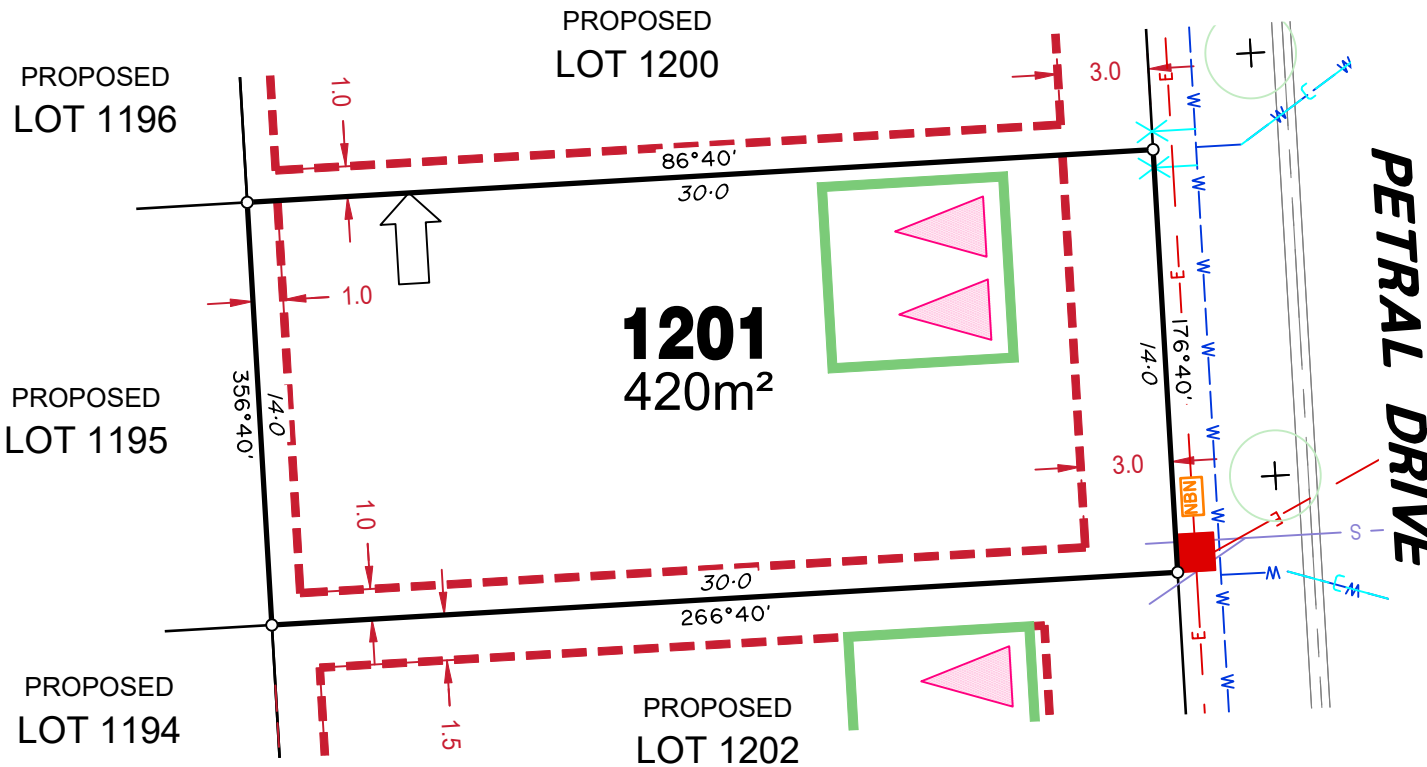

LEGEND

Rock Retaining Wall shown as:-	
Sleeper Retaining Wall shown as:-	
Landscape Retaining Wall shown as:-	
Sewer line	
Sewer Manhole	
Roofwater Drainage line and Catch Pit	
Stormwater Drainage Line	
Stormwater Manhole	
Stormwater Pit	
Water Main	
Water Conduit	
Water Service Point of Entry	
Underground Electricity, Street Light, Electricity Pillar & NBN	
Developer Fencing	
Concrete Pathway	
Zero Setback Building Line	
Landscape Street Tree	
Indicative Building Envelope	
Bin Pads	
Proposed Services Easement	
Indicative Parking Access Location	

ADDITIONAL NOTES:

Allotments used as Multiple Residential Allotments in accordance with the approved Plan of Development may have a reduced primary road setback to 3.0metres as noted on the Plan of Development Table.

Compaction of any fill material placed on this site shall be completed to level one inspection and testing services in accordance with AS3798-2007.

Location of sewer, roofwater, stormwater, water reticulation and electricity lines, manholes and pits are those shown on engineering design drawings, supplied by Colliers and may differ from the as-constructed location.

Plan of Development information Supplied by RPS Group PLC.

Copyright © Veris Australia Pty Ltd
May 2023.

Plot Date: 19 May, 2023
 Computer File Ref: 430109_S3D-SP-B.dwg

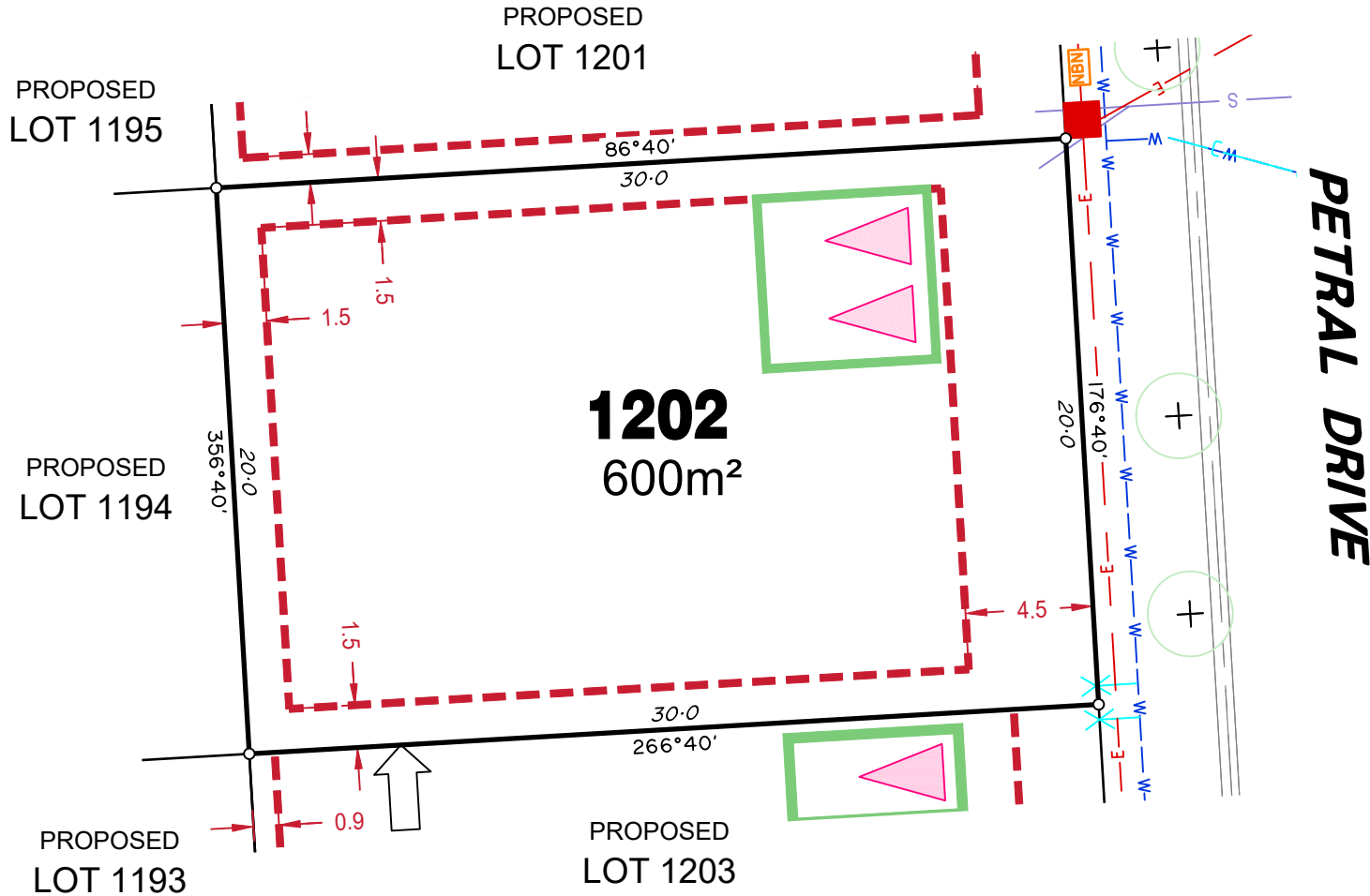

LEGEND

Rock Retaining Wall shown as:-	
Sleeper Retaining Wall shown as:-	
Landscape Retaining Wall shown as:-	
Sewer line	
Sewer Manhole	
Roofwater Drainage line and Catch Pit	
Stormwater Drainage Line	
Stormwater Manhole	
Stormwater Pit	
Water Main	
Water Conduit	
Water Service Point of Entry	
Underground Electricity, Street Light, Electricity Pillar & NBN	
Developer Fencing	
Concrete Pathway	
Zero Setback Building Line	
Indicative Building Envelope	
Bin Pads	
Proposed Services Easement	
Indicative Parking Access Location	
Landscape Street Tree	

ADDITIONAL NOTES:

Allotments used as Multiple Residential Allotments in accordance with the approved Plan of Development may have a reduced primary road setback to 3.0metres as noted on the Plan of Development Table.

Compaction of any fill material placed on this site shall be completed to level one inspection and testing services in accordance with AS3798-2007.

Location of sewer, roofwater, stormwater, water reticulation and electricity lines, manholes and pits are those shown on engineering design drawings, supplied by Colliers and may differ from the as-constructed location.

Plan of Development information Supplied by RPS Group PLC.

Copyright © Veris Australia Pty Ltd
May 2023.

Plot Date: 19 May, 2023
 Computer File Ref: 430109_S3D-SP-B.dwg

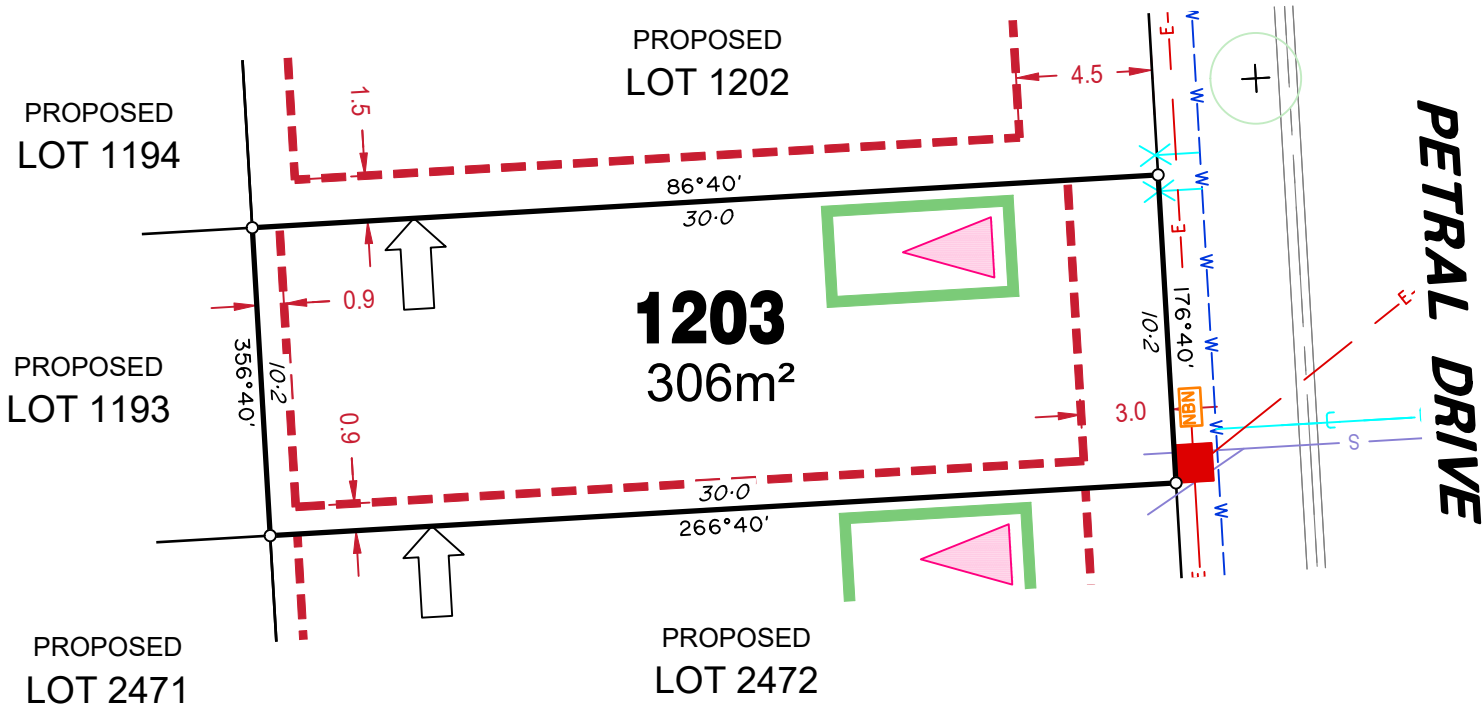

LEGEND

- Rock Retaining Wall shown as:-
- Sleeper Retaining Wall shown as:-
- Landscape Retaining Wall shown as:-
- Sewer line
- Sewer Manhole
- Roofwater Drainage line and Catch Pit
- Stormwater Drainage Line
- Stormwater Manhole
- Stormwater Pit
- Water Main
- Water Conduit
- Water Service Point of Entry
- Underground Electricity, Street Light, Electricity Pillar & NBN
- Developer Fencing
- Concrete Pathway
- Landscape Street Tree
- Zero Setback Building Line
- Indicative Building Envelope
- Bin Pads
- Proposed Services Easement
- Indicative Parking Access Location

ADDITIONAL NOTES:

Allotments used as Multiple Residential Allotments in accordance with the approved Plan of Development may have a reduced primary road setback to 3.0metres as noted on the Plan of Development Table.

Compaction of any fill material placed on this site shall be completed to level one inspection and testing services in accordance with AS3798-2007.

Location of sewer, roofwater, stormwater, water reticulation and electricity lines, manholes and pits are those shown on engineering design drawings, supplied by Colliers and may differ from the as-constructed location.

Plan of Development information Supplied by RPS Group PLC.

Copyright © Veris Australia Pty Ltd
May 2023.

Plot Date: 19 May, 2023
 Computer File Ref: 430109_S3D-SP-B.dwg

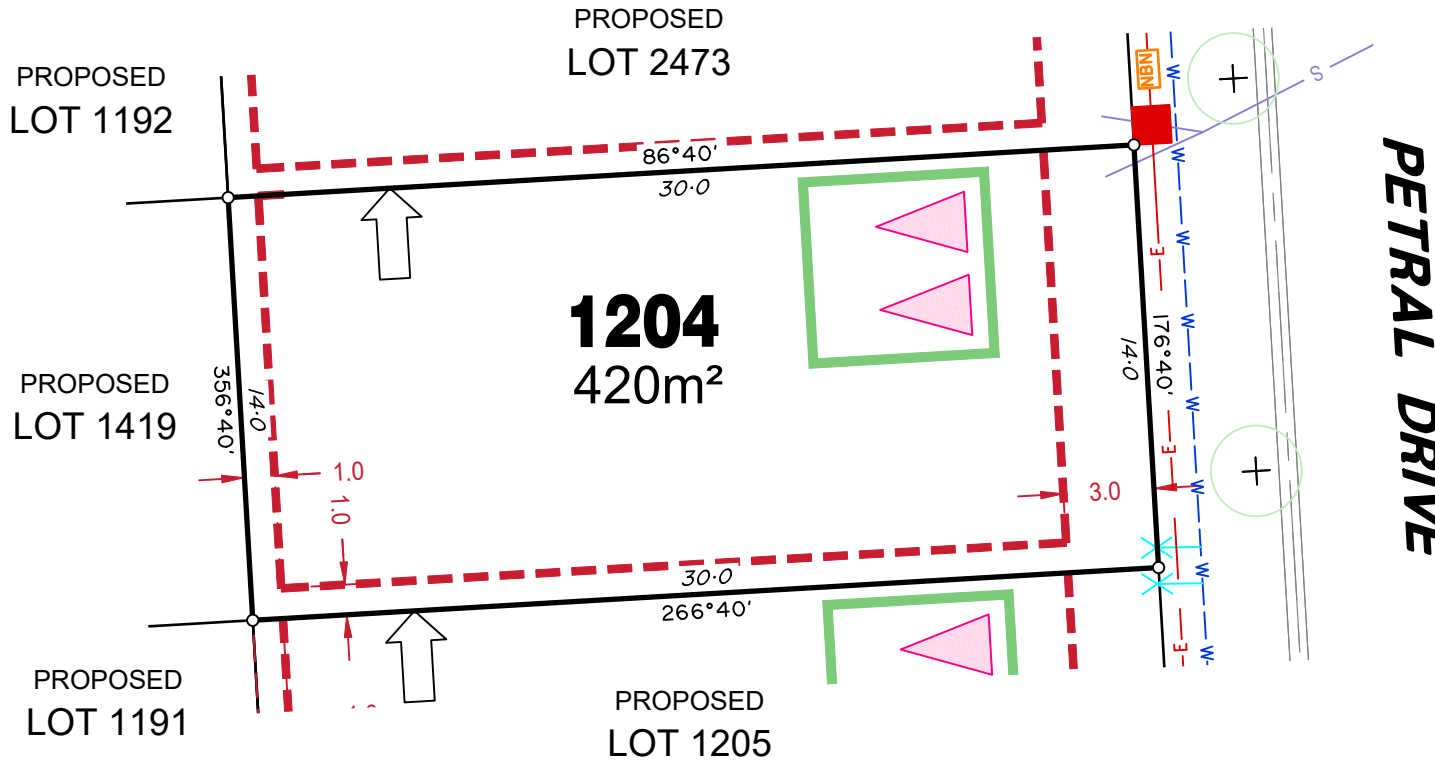

PETRAL DRIVE

LEGEND

Rock Retaining Wall shown as:-	
Sleeper Retaining Wall shown as:-	
Landscape Retaining Wall shown as:-	
Sewer line	
Sewer Manhole	
Roofwater Drainage line and Catch Pit	
Stormwater Drainage Line	
Stormwater Manhole	
Stormwater Pit	
Water Main	
Water Conduit	
Water Service Point of Entry	
Underground Electricity, Street Light, Electricity Pillar & NBN	
Developer Fencing	
Concrete Pathway	
Zero Setback Building Line	
Indicative Building Envelope	
Bin Pads	
Proposed Services Easement	
Indicative Parking Access Location	
Landscape Street Tree	

ADDITIONAL NOTES:

Allotments used as Multiple Residential Allotments in accordance with the approved Plan of Development may have a reduced primary road setback to 3.0metres as noted on the Plan of Development Table.

Compaction of any fill material placed on this site shall be completed to level one inspection and testing services in accordance with AS3798-2007.

Location of sewer, roofwater, stormwater, water reticulation and electricity lines, manholes and pits are those shown on engineering design drawings, supplied by Colliers and may differ from the as-constructed location.

Plan of Development information Supplied by RPS Group PLC.

Copyright © Veris Australia Pty Ltd
May 2023.

Plot Date: 19 May, 2023
 Computer File Ref: 430109_S3D-SP-B.dwg

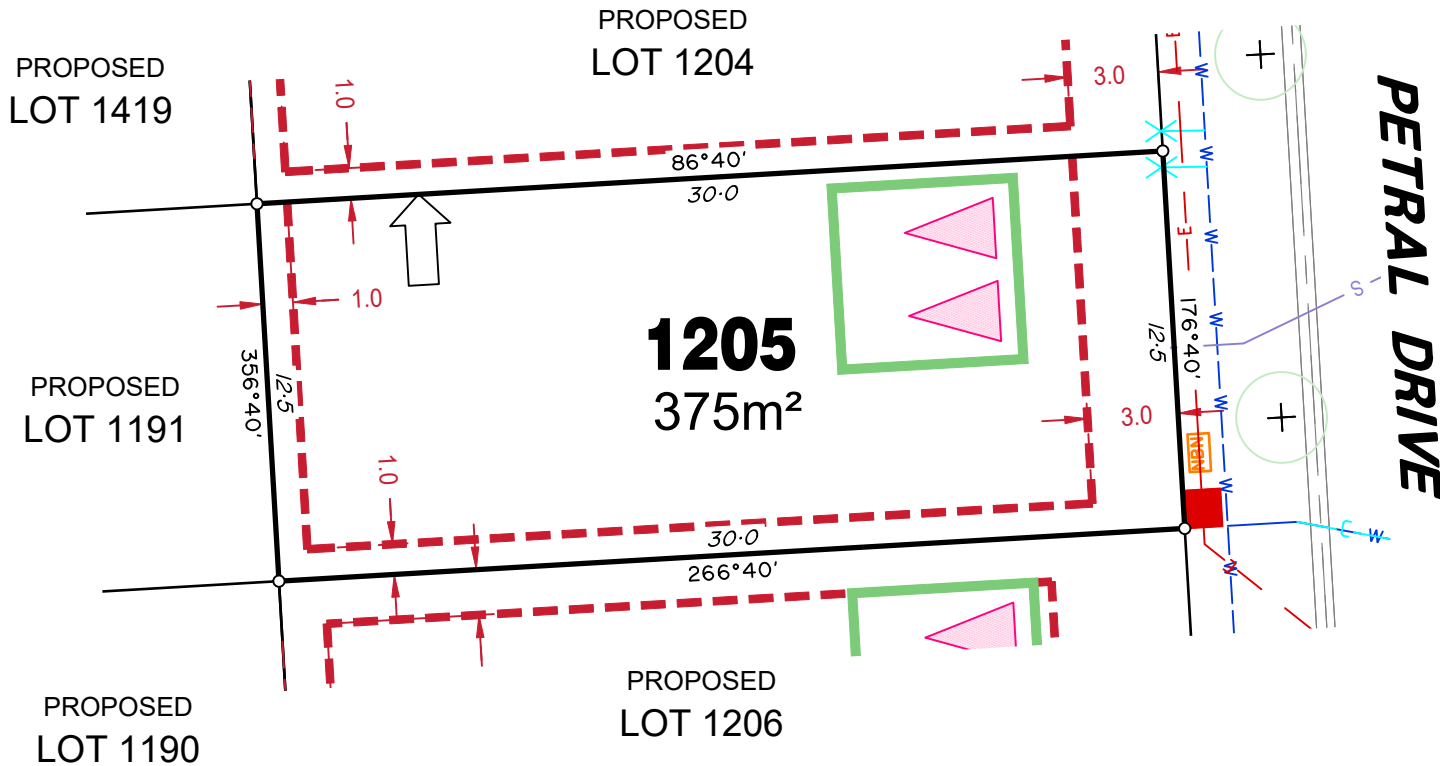

LEGEND

Rock Retaining Wall shown as:-	
Sleeper Retaining Wall shown as:-	
Landscape Retaining Wall shown as:-	
Sewer line	
Sewer Manhole	
Roofwater Drainage line and Catch Pit	
Stormwater Drainage Line	
Stormwater Manhole	
Stormwater Pit	
Water Main	
Water Conduit	
Water Service Point of Entry	
Underground Electricity, Street Light, Electricity Pillar & NBN	
Developer Fencing	
Concrete Pathway	
Zero Setback Building Line	
Indicative Building Envelope	
Bin Pads	
Proposed Services Easement	
Indicative Parking Access Location	
Landscape Street Tree	

ADDITIONAL NOTES:

Allotments used as Multiple Residential Allotments in accordance with the approved Plan of Development may have a reduced primary road setback to 3.0metres as noted on the Plan of Development Table.

Compaction of any fill material placed on this site shall be completed to level one inspection and testing services in accordance with AS3798-2007.

Location of sewer, roofwater, stormwater, water reticulation and electricity lines, manholes and pits are those shown on engineering design drawings, supplied by Colliers and may differ from the as-constructed location.

Plan of Development information Supplied by RPS Group PLC.

Copyright © Veris Australia Pty Ltd
May 2023.

Plot Date: 19 May, 2023
 Computer File Ref: 430109_S3D-SP-B.dwg



LEGEND

Rock Retaining Wall shown as:-	
Sleeper Retaining Wall shown as:-	
Landscape Retaining Wall shown as:-	
Sewer line	
Sewer Manhole	
Roofwater Drainage line and Catch Pit	
Stormwater Drainage Line	
Stormwater Manhole	
Stormwater Pit	
Water Main	
Water Conduit	
Water Service Point of Entry	
Underground Electricity, Street Light, Electricity Pillar & NBN	
Developer Fencing	
Concrete Pathway	
Zero Setback Building Line	
Landscape Street Tree	
Indicative Building Envelope	
Bin Pads	
Proposed Services Easement	
Indicative Parking Access Location	

ADDITIONAL NOTES:

Allotments used as Multiple Residential Allotments in accordance with the approved Plan of Development may have a reduced primary road setback to 3.0metres as noted on the Plan of Development Table.

Compaction of any fill material placed on this site shall be completed to level one inspection and testing services in accordance with AS3798-2007.

Location of sewer, roofwater, stormwater, water reticulation and electricity lines, manholes and pits are those shown on engineering design drawings, supplied by Colliers and may differ from the as-constructed location.

Plan of Development information Supplied by RPS Group PLC.

Copyright © Veris Australia Pty Ltd
May 2023.

Plot Date: 19 May, 2023
 Computer File Ref: 430109_St3D-SP-B.dwg

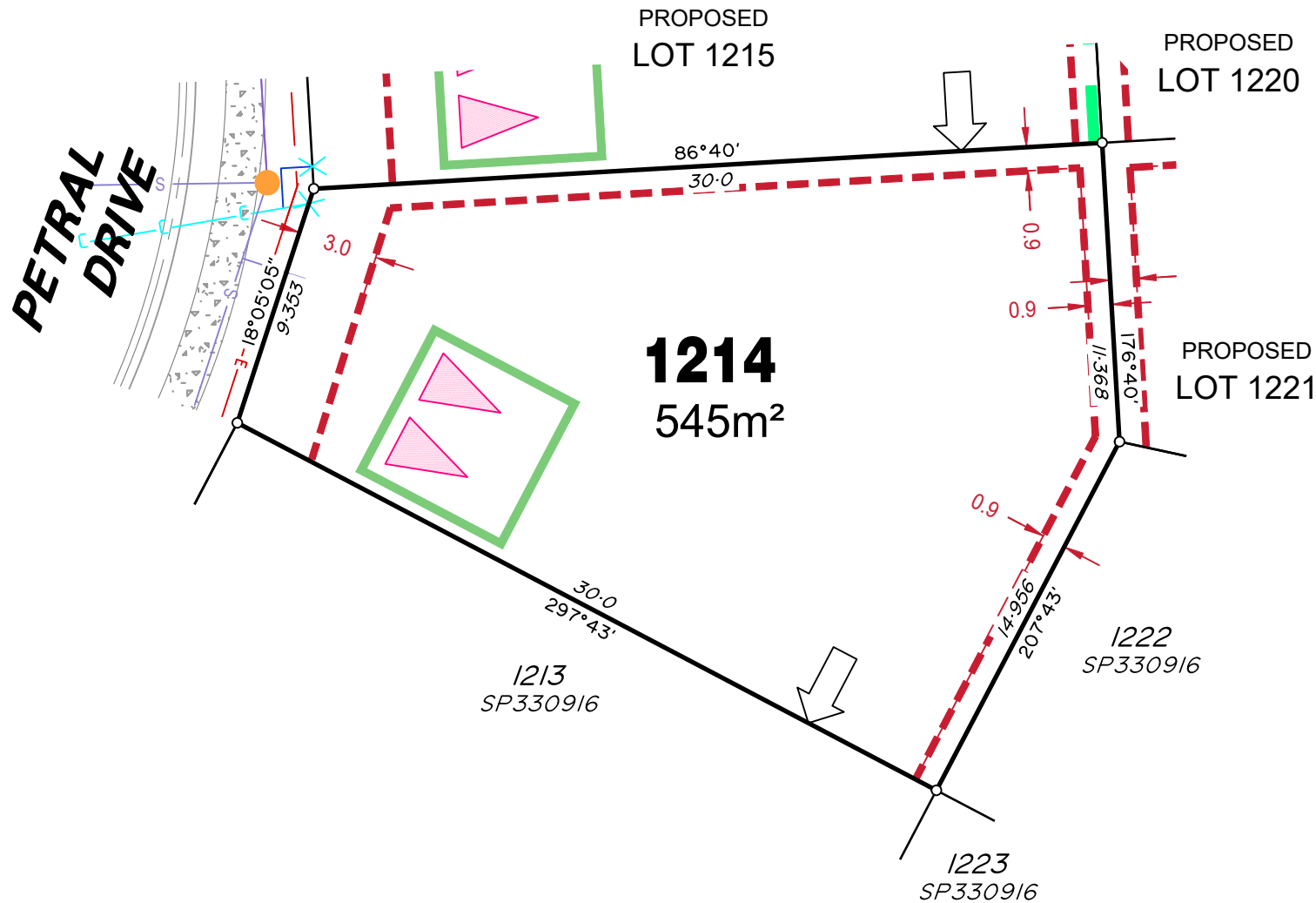

LEGEND

Rock Retaining Wall shown as:-	
Sleeper Retaining Wall shown as:-	
Landscape Retaining Wall shown as:-	
Sewer line	
Sewer Manhole	
Roofwater Drainage line and Catch Pit	
Stormwater Drainage Line	
Stormwater Manhole	
Stormwater Pit	
Water Main	
Water Conduit	
Water Service Point of Entry	
Underground Electricity, Street Light, Electricity Pillar & NBN	
Developer Fencing	
Concrete Pathway	
Zero Setback Building Line	
Indicative Building Envelope	
Bin Pads	
Proposed Services Easement	
Indicative Parking Access Location	
Landscape Street Tree	

ADDITIONAL NOTES:

Allotments used as Multiple Residential Allotments in accordance with the approved Plan of Development may have a reduced primary road setback to 3.0metres as noted on the Plan of Development Table.

Compaction of any fill material placed on this site shall be completed to level one inspection and testing services in accordance with AS3798-2007.

Location of sewer, roofwater, stormwater, water reticulation and electricity lines, manholes and pits are those shown on engineering design drawings, supplied by Colliers and may differ from the as-constructed location.

Plan of Development information Supplied by RPS Group PLC.

Copyright © Veris Australia Pty Ltd
May 2023.

Plot Date: 19 May, 2023
Computer File Ref: 430109_S3D-SP-B.dwg



PETRAL DRIVE

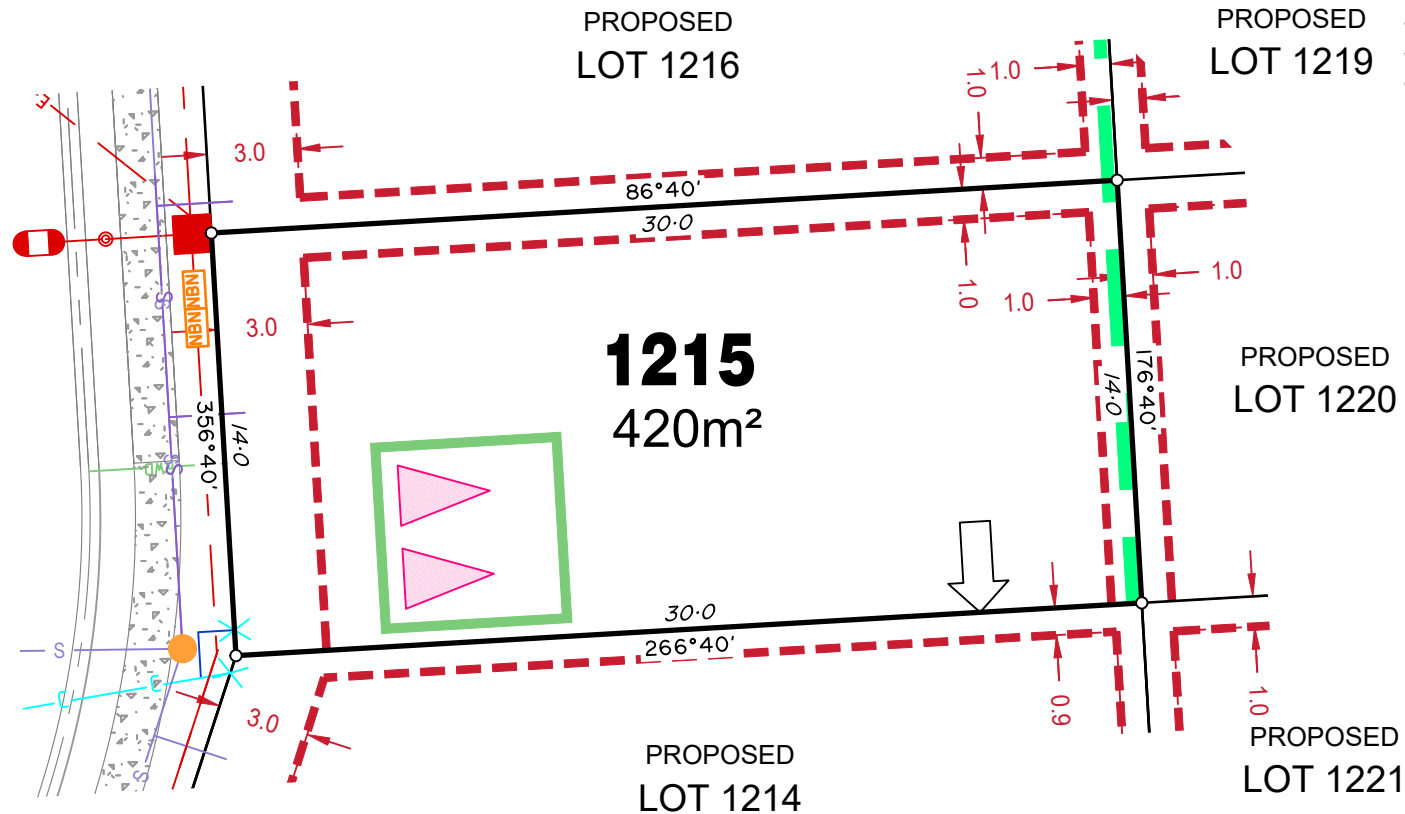

LEGEND

Rock Retaining Wall shown as:-	
Sleeper Retaining Wall shown as:-	
Landscape Retaining Wall shown as:-	
Sewer line	
Sewer Manhole	
Roofwater Drainage line and Catch Pit	
Stormwater Drainage Line	
Stormwater Manhole	
Stormwater Pit	
Water Main	
Water Conduit	
Water Service Point of Entry	
Underground Electricity, Street Light, Electricity Pillar & NBN	
Developer Fencing	
Concrete Pathway	
Zero Setback Building Line	
Landscape Street Tree	
Indicative Building Envelope	
Bin Pads	
Proposed Services Easement	
Indicative Parking Access Location	

ADDITIONAL NOTES:

Allotments used as Multiple Residential Allotments in accordance with the approved Plan of Development may have a reduced primary road setback to 3.0metres as noted on the Plan of Development Table.

Compaction of any fill material placed on this site shall be completed to level one inspection and testing services in accordance with AS3798-2007.

Location of sewer, roofwater, stormwater, water reticulation and electricity lines, manholes and pits are those shown on engineering design drawings, supplied by Colliers and may differ from the as-constructed location.

Plan of Development information Supplied by RPS Group PLC.

Copyright © Veris Australia Pty Ltd
May 2023.

Plot Date: 19 May, 2023
Computer File Ref: 430109_St3D-SP-B.dwg



PETRAL DRIVE

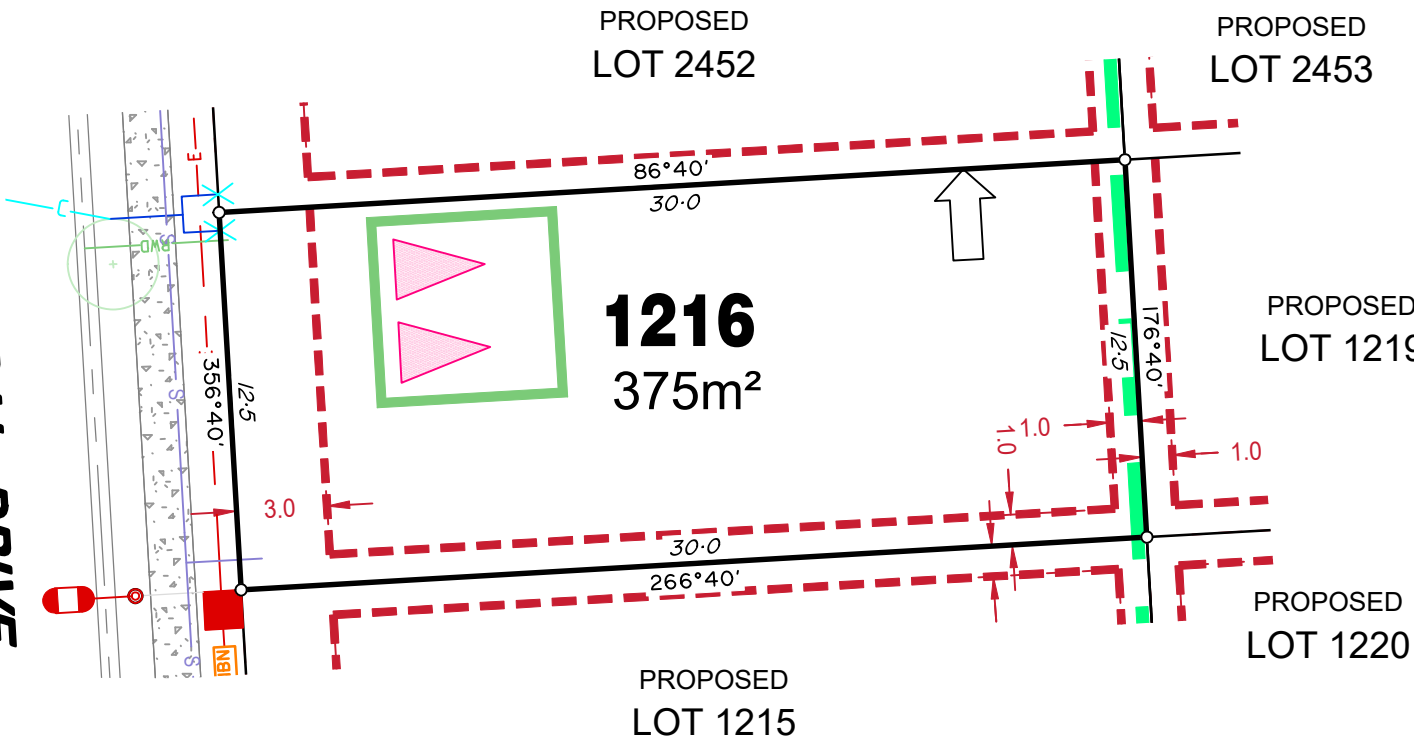

LEGEND

Rock Retaining Wall shown as:-	
Sleeper Retaining Wall shown as:-	
Landscape Retaining Wall shown as:-	
Sewer line	
Sewer Manhole	
Roofwater Drainage line and Catch Pit	
Stormwater Drainage Line	
Stormwater Manhole	
Stormwater Pit	
Water Main	
Water Conduit	
Water Service Point of Entry	
Underground Electricity, Street Light, Electricity Pillar & NBN	
Developer Fencing	
Concrete Pathway	
Zero Setback Building Line	
Landscape Street Tree	
Indicative Building Envelope	
Bin Pads	
Proposed Services Easement	
Indicative Parking Access Location	

ADDITIONAL NOTES:

Allotments used as Multiple Residential Allotments in accordance with the approved Plan of Development may have a reduced primary road setback to 3.0metres as noted on the Plan of Development Table.

Compaction of any fill material placed on this site shall be completed to level one inspection and testing services in accordance with AS3798-2007.

Location of sewer, roofwater, stormwater, water reticulation and electricity lines, manholes and pits are those shown on engineering design drawings, supplied by Colliers and may differ from the as-constructed location.

Plan of Development information Supplied by RPS Group PLC.

Copyright © Veris Australia Pty Ltd
May 2023.

Plot Date: 12 May, 2023
 Computer File Ref: 430109_ST3D-SP-B.dwg



HAWK LANE

PETRAL DRIVE

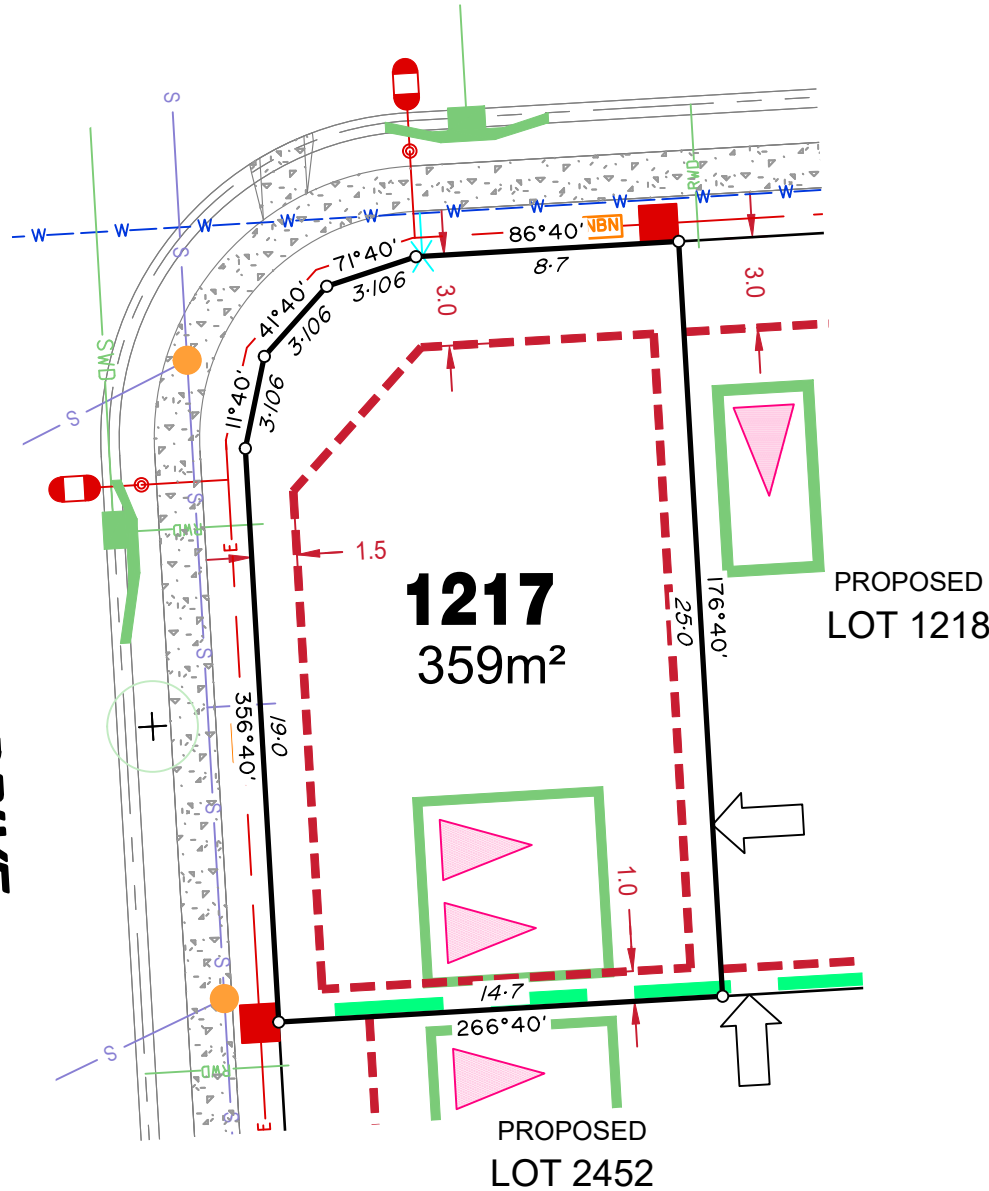

LEGEND

Rock Retaining Wall shown as:-	
Sleeper Retaining Wall shown as:-	
Landscape Retaining Wall shown as:-	
Sewer line	
Sewer Manhole	
Roofwater Drainage line and Catch Pit	
Stormwater Drainage Line	
Stormwater Manhole	
Stormwater Pit	
Water Main	
Water Conduit	
Water Service Point of Entry	
Underground Electricity, Street Light, Electricity Pillar & NBN	
Developer Fencing	
Concrete Pathway	
Zero Setback Building Line	
Landscape Street Tree	
Indicative Building Envelope	
Bin Pads	
Proposed Services Easement	
Indicative Parking Access Location	

ADDITIONAL NOTES:

Allotments used as Multiple Residential Allotments in accordance with the approved Plan of Development may have a reduced primary road setback to 3.0metres as noted on the Plan of Development Table.

Compaction of any fill material placed on this site shall be completed to level one inspection and testing services in accordance with AS3798-2007.

Location of sewer, roofwater, stormwater, water reticulation and electricity lines, manholes and pits are those shown on engineering design drawings, supplied by Colliers and may differ from the as-constructed location.

Plan of Development information Supplied by RPS Group PLC.

Copyright © Veris Australia Pty Ltd
May 2023.

Plot Date: 19 May, 2023
 Computer File Ref: 430109_S3D-SP-B.dwg



HAWK LANE

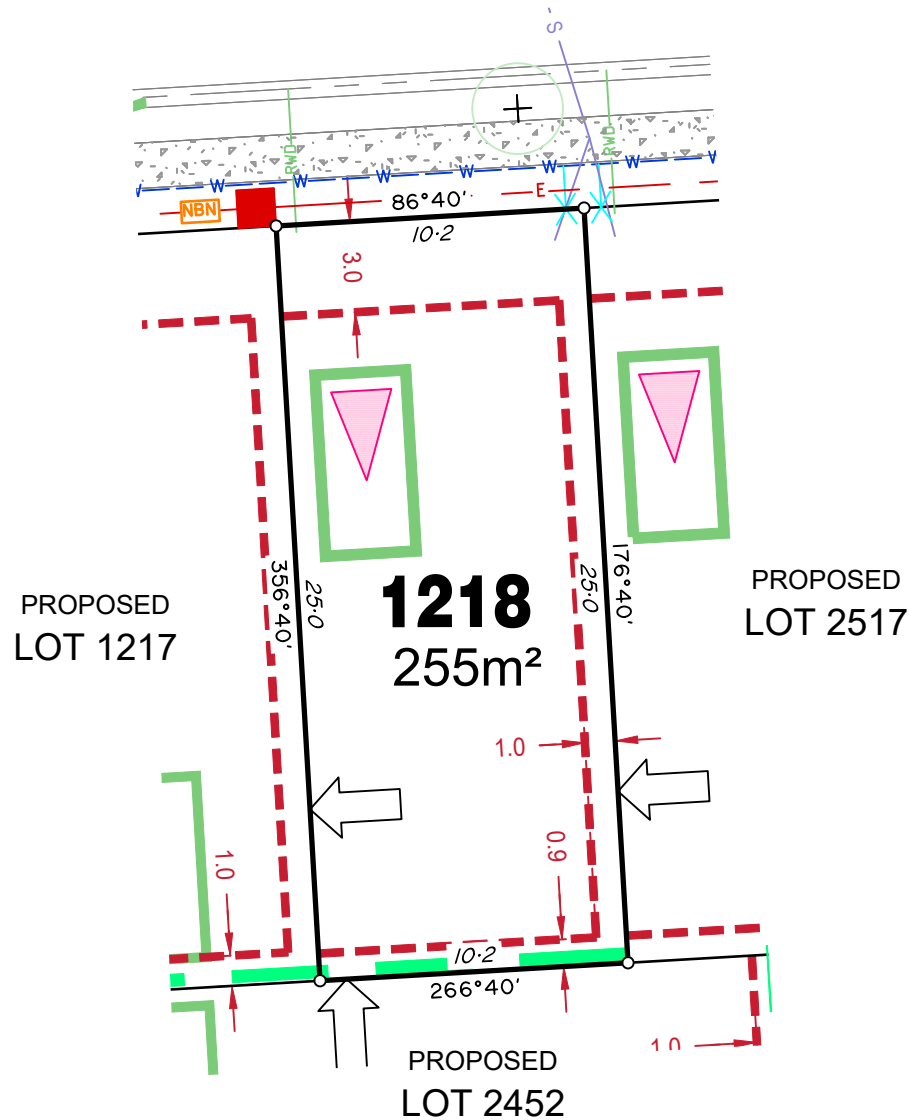

LEGEND

Rock Retaining Wall shown as:-	
Sleeper Retaining Wall shown as:-	
Landscape Retaining Wall shown as:-	
Sewer line	
Sewer Manhole	
Roofwater Drainage line and Catch Pit	
Stormwater Drainage Line	
Stormwater Manhole	
Stormwater Pit	
Water Main	
Water Conduit	
Water Service Point of Entry	
Underground Electricity, Street Light, Electricity Pillar & NBN	
Developer Fencing	
Concrete Pathway	
Zero Setback Building Line	
Landscape Street Tree	
Indicative Building Envelope	
Bin Pads	
Proposed Services Easement	
Indicative Parking Access Location	

ADDITIONAL NOTES:

Allotments used as Multiple Residential Allotments in accordance with the approved Plan of Development may have a reduced primary road setback to 3.0metres as noted on the Plan of Development Table.

Compaction of any fill material placed on this site shall be completed to level one inspection and testing services in accordance with AS3798-2007.

Location of sewer, roofwater, stormwater, water reticulation and electricity lines, manholes and pits are those shown on engineering design drawings, supplied by Colliers and may differ from the as-constructed location.

Plan of Development information Supplied by RPS Group PLC.

Copyright © Veris Australia Pty Ltd
May 2023.

Plot Date: 19 May, 2023
 Computer File Ref: 430109_St3D-SP-B.dwg

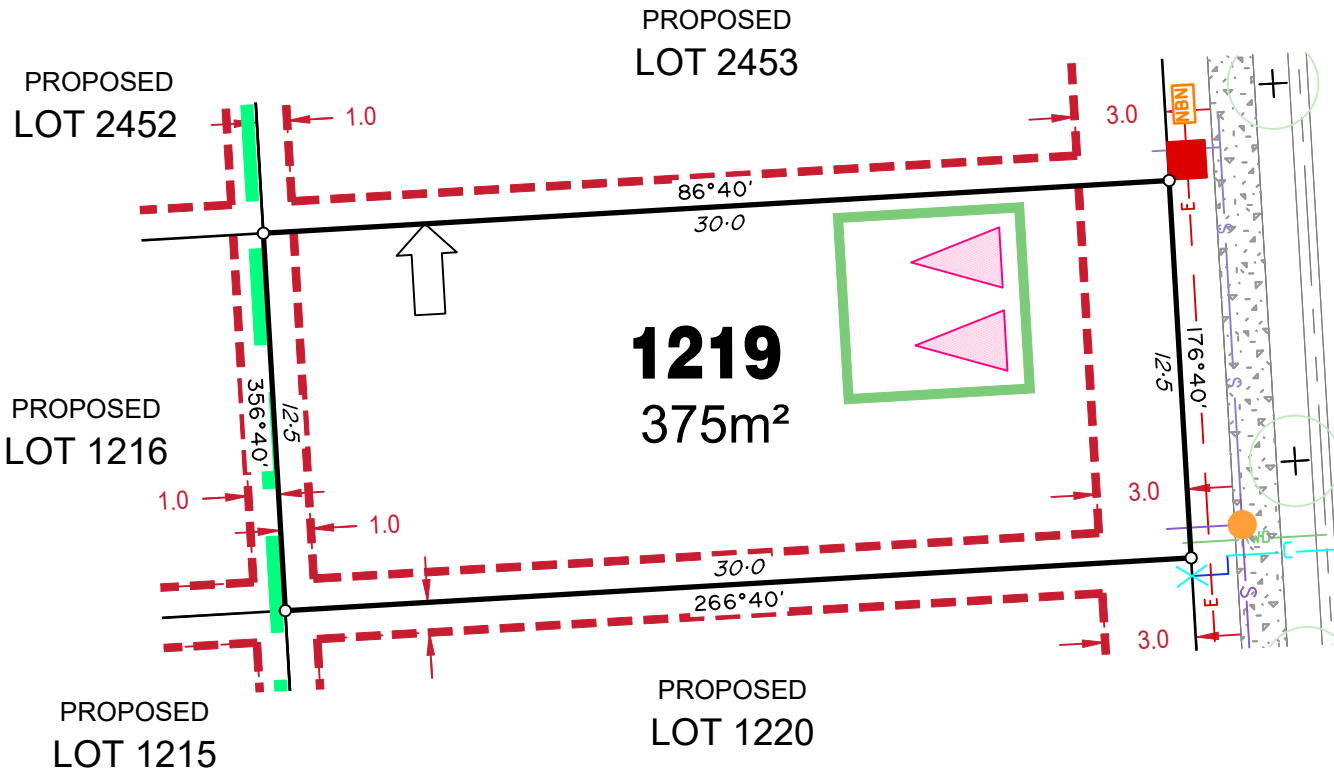

LEGEND

Rock Retaining Wall shown as:-	
Sleeper Retaining Wall shown as:-	
Landscape Retaining Wall shown as:-	
Sewer line	
Sewer Manhole	
Roofwater Drainage line and Catch Pit	
Stormwater Drainage Line	
Stormwater Manhole	
Stormwater Pit	
Water Main	
Water Conduit	
Water Service Point of Entry	
Underground Electricity, Street Light, Electricity Pillar & NBN	
Developer Fencing	
Concrete Pathway	
Zero Setback Building Line	
Landscape Street Tree	
Indicative Building Envelope	
Bin Pads	
Proposed Services Easement	
Indicative Parking Access Location	

COLLEGE DRIVE

ADDITIONAL NOTES:

Allotments used as Multiple Residential Allotments in accordance with the approved Plan of Development may have a reduced primary road setback to 3.0metres as noted on the Plan of Development Table.

Compaction of any fill material placed on this site shall be completed to level one inspection and testing services in accordance with AS3798-2007.

Location of sewer, roofwater, stormwater, water reticulation and electricity lines, manholes and pits are those shown on engineering design drawings, supplied by Colliers and may differ from the as-constructed location.

Plan of Development information Supplied by RPS Group PLC.

Copyright © Veris Australia Pty Ltd
May 2023.

Plot Date: 19 May, 2023
 Computer File Ref: 430109_St3D-SP-B.dwg



PROPOSED
LOT 1216

PROPOSED
LOT 1219

PROPOSED
LOT 1215

1220
420m²

PROPOSED
LOT 1214

PROPOSED
LOT 1221

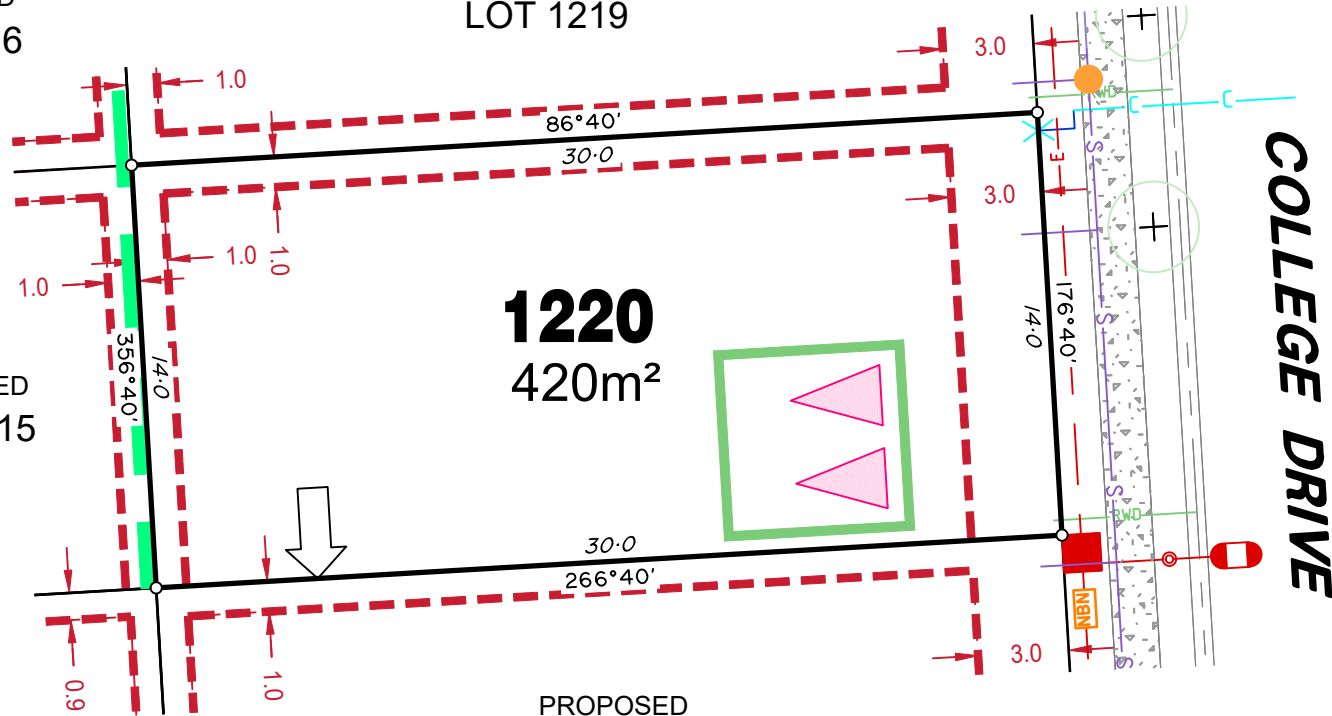

LEGEND

Rock Retaining Wall shown as:-	
Sleeper Retaining Wall shown as:-	
Landscape Retaining Wall shown as:-	
Sewer line	
Sewer Manhole	
Roofwater Drainage line and Catch Pit	
Stormwater Drainage Line	
Stormwater Manhole	
Stormwater Pit	
Water Main	
Water Conduit	
Water Service Point of Entry	
Underground Electricity, Street Light, Electricity Pillar & NBN	
Developer Fencing	
Concrete Pathway	
Landscape Street Tree	
Zero Setback Building Line	
Indicative Building Envelope	
Bin Pads	
Proposed Services Easement	
Indicative Parking Access Location	

ADDITIONAL NOTES:

Allotments used as Multiple Residential Allotments in accordance with the approved Plan of Development may have a reduced primary road setback to 3.0metres as noted on the Plan of Development Table.

Compaction of any fill material placed on this site shall be completed to level one inspection and testing services in accordance with AS3798-2007.

Location of sewer, roofwater, stormwater, water reticulation and electricity lines, manholes and pits are those shown on engineering design drawings, supplied by Colliers and may differ from the as-constructed location.

Plan of Development information Supplied by RPS Group PLC.

Copyright © Veris Australia Pty Ltd
May 2023.

Plot Date: 19 May, 2023
Computer File Ref: 430109_S3D-SP-B.dwg



PROPOSED LOT 1340

PROPOSED LOT 1329

PROPOSED LOT 1341

1328
592m²

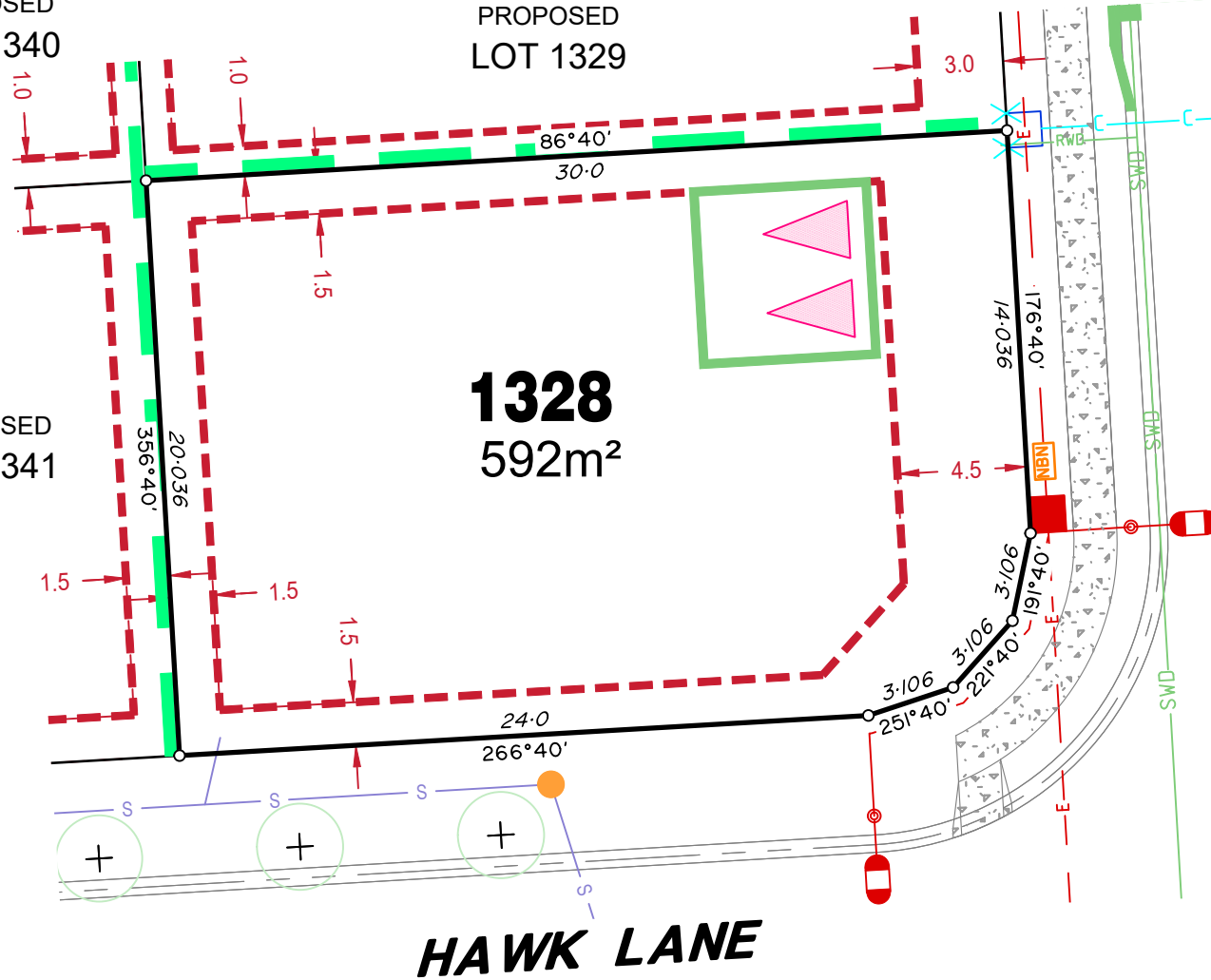

LEGEND

Rock Retaining Wall shown as:-	
Sleeper Retaining Wall shown as:-	
Landscape Retaining Wall shown as:-	
Sewer line	
Sewer Manhole	
Roofwater Drainage line and Catch Pit	
Stormwater Drainage Line	
Stormwater Manhole	
Stormwater Pit	
Water Main	
Water Conduit	
Water Service Point of Entry	
Underground Electricity, Street Light, Electricity Pillar & NBN	
Developer Fencing	
Concrete Pathway	
Zero Setback Building Line	
Landscape Street Tree	
Indicative Building Envelope	
Bin Pads	
Proposed Services Easement	
Indicative Parking Access Location	

ADDITIONAL NOTES:

Allotments used as Multiple Residential Allotments in accordance with the approved Plan of Development may have a reduced primary road setback to 3.0metres as noted on the Plan of Development Table.

Compaction of any fill material placed on this site shall be completed to level one inspection and testing services in accordance with AS3798-2007.

Location of sewer, roofwater, stormwater, water reticulation and electricity lines, manholes and pits are those shown on engineering design drawings, supplied by Colliers and may differ from the as-constructed location.

Plan of Development information Supplied by RPS Group PLC.

Copyright © Veris Australia Pty Ltd
May 2023.

Plot Date: 19 May, 2023
Computer File Ref: 430109_S3D-SP-B.dwg

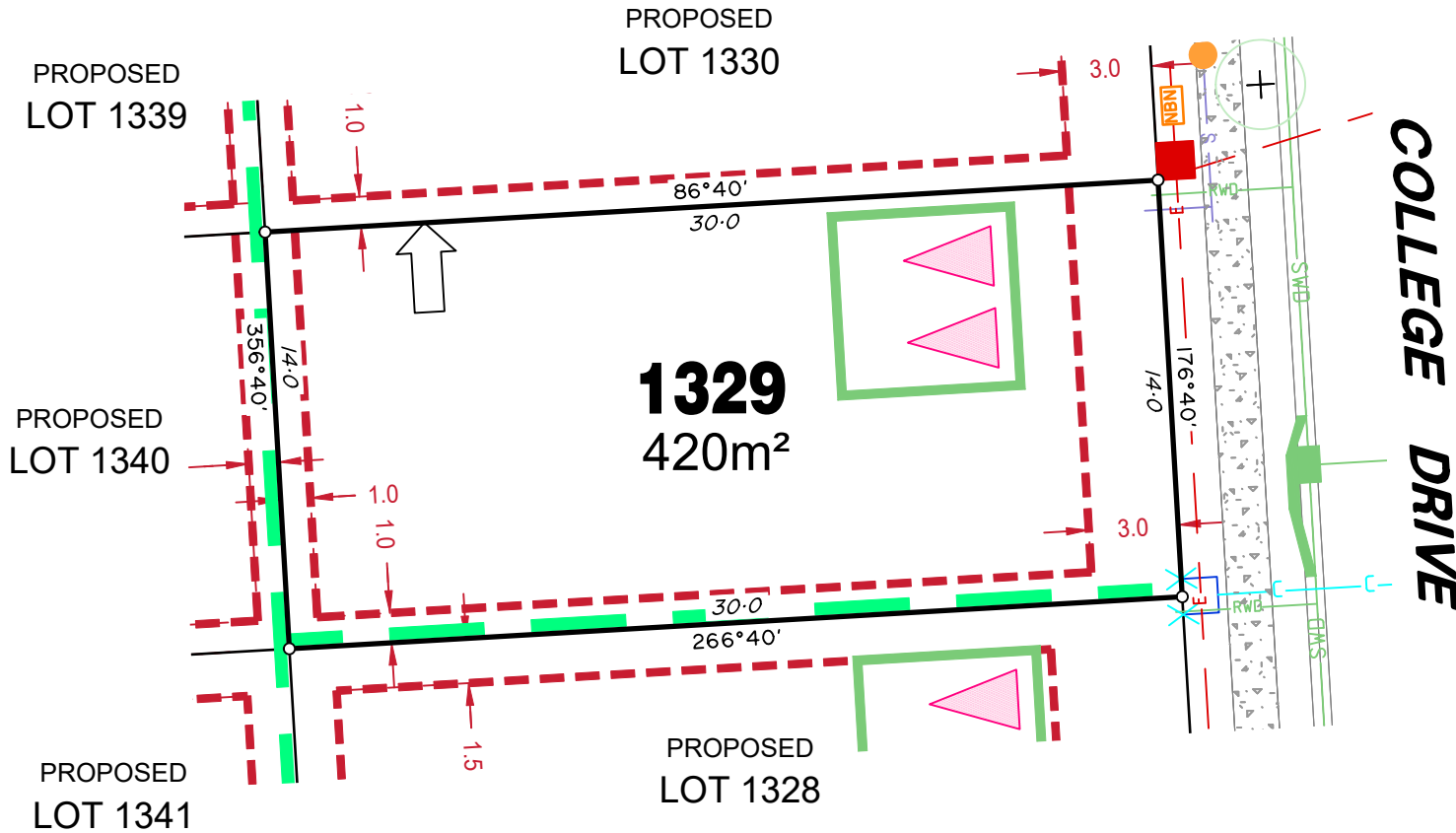

LEGEND

Rock Retaining Wall shown as:-	
Sleeper Retaining Wall shown as:-	
Landscape Retaining Wall shown as:-	
Sewer line	
Sewer Manhole	
Roofwater Drainage line and Catch Pit	
Stormwater Drainage Line	
Stormwater Manhole	
Stormwater Pit	
Water Main	
Water Conduit	
Water Service Point of Entry	
Underground Electricity, Street Light, Electricity Pillar & NBN	
Developer Fencing	
Concrete Pathway	
Zero Setback Building Line	
Landscape Street Tree	
Indicative Building Envelope	
Bin Pads	
Proposed Services Easement	
Indicative Parking Access Location	

ADDITIONAL NOTES:

Allotments used as Multiple Residential Allotments in accordance with the approved Plan of Development may have a reduced primary road setback to 3.0metres as noted on the Plan of Development Table.

Compaction of any fill material placed on this site shall be completed to level one inspection and testing services in accordance with AS3798-2007.

Location of sewer, roofwater, stormwater, water reticulation and electricity lines, manholes and pits are those shown on engineering design drawings, supplied by Colliers and may differ from the as-constructed location.

Plan of Development information Supplied by RPS Group PLC.

Copyright © Veris Australia Pty Ltd
May 2023.

Plot Date: 19 May, 2023
Computer File Ref: 430109_St3D-SP-B.dwg

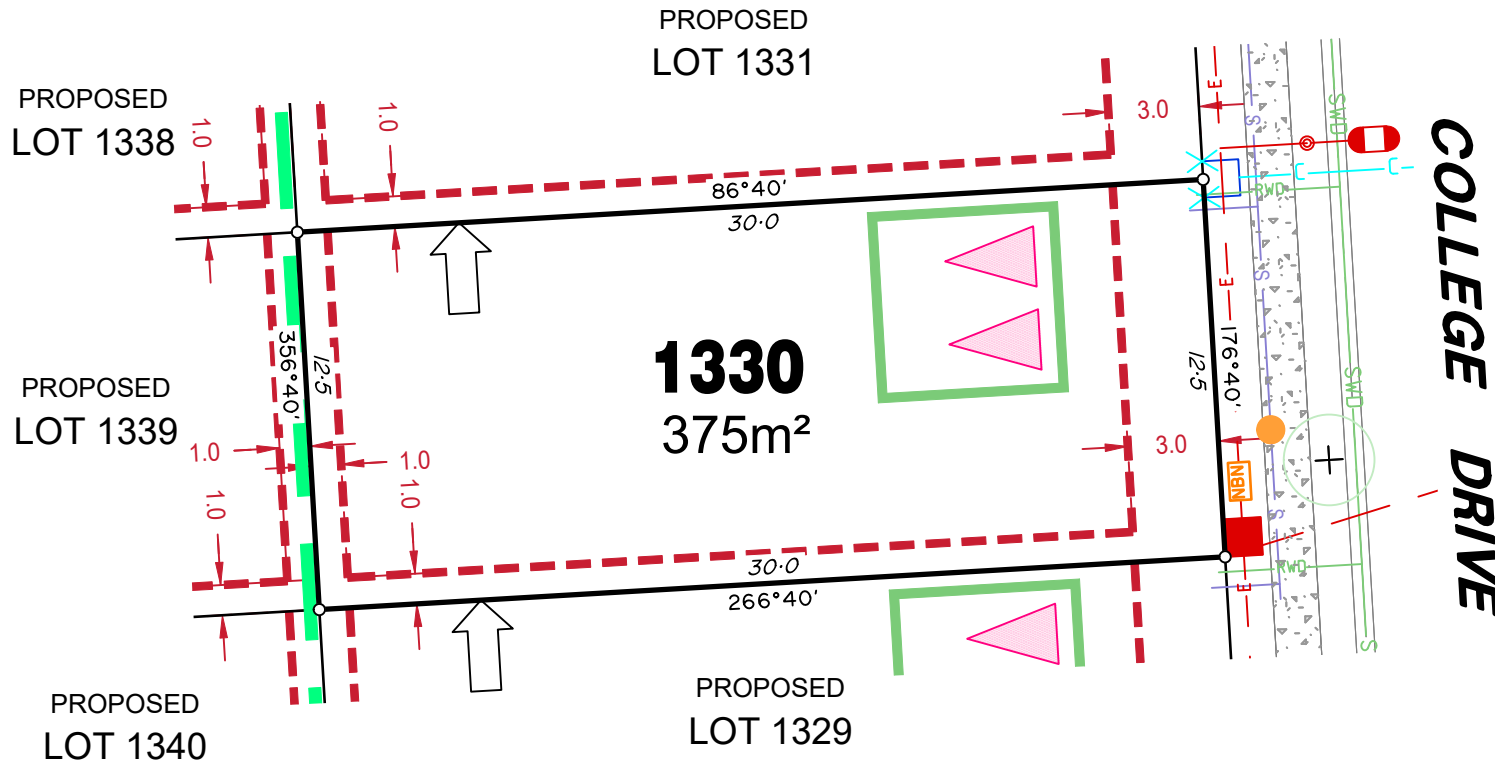

LEGEND

Rock Retaining Wall shown as:-	
Sleeper Retaining Wall shown as:-	
Landscape Retaining Wall shown as:-	
Sewer line	
Sewer Manhole	
Roofwater Drainage line and Catch Pit	
Stormwater Drainage Line	
Stormwater Manhole	
Stormwater Pit	
Water Main	
Water Conduit	
Water Service Point of Entry	
Underground Electricity, Street Light, Electricity Pillar & NBN	
Developer Fencing	
Concrete Pathway	
Zero Setback Building Line	
Landscape Street Tree	
Indicative Building Envelope	
Bin Pads	
Proposed Services Easement	
Indicative Parking Access Location	

ADDITIONAL NOTES:

Allotments used as Multiple Residential Allotments in accordance with the approved Plan of Development may have a reduced primary road setback to 3.0metres as noted on the Plan of Development Table.

Compaction of any fill material placed on this site shall be completed to level one inspection and testing services in accordance with AS3798-2007.

Location of sewer, roofwater, stormwater, water reticulation and electricity lines, manholes and pits are those shown on engineering design drawings, supplied by Colliers and may differ from the as-constructed location.

Plan of Development information Supplied by RPS Group PLC.

Copyright © Veris Australia Pty Ltd
May 2023.

Plot Date: 19 May, 2023
Computer File Ref: 430109_S3D-SP-B.dwg

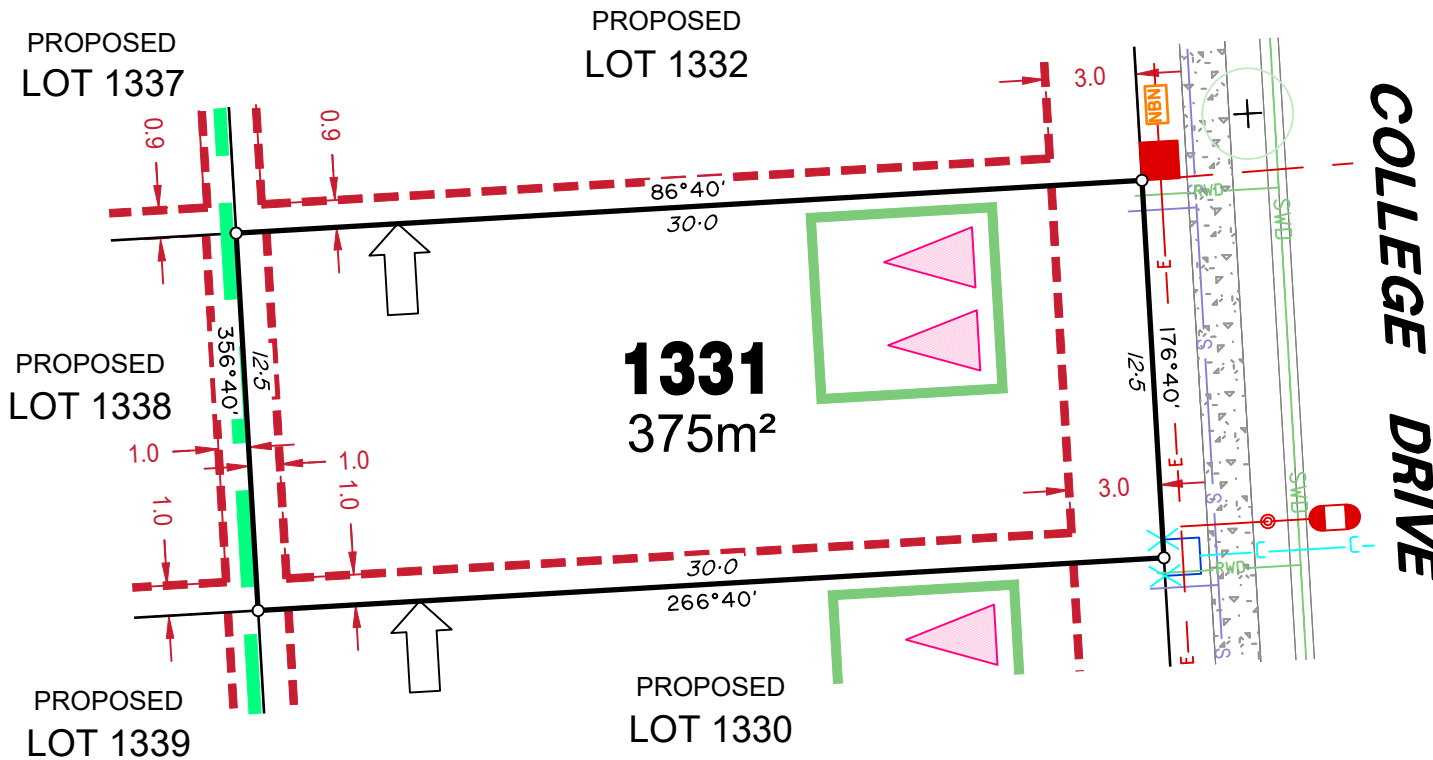

LEGEND

Rock Retaining Wall shown as:-	
Sleeper Retaining Wall shown as:-	
Landscape Retaining Wall shown as:-	
Sewer line	
Sewer Manhole	
Roofwater Drainage line and Catch Pit	
Stormwater Drainage Line	
Stormwater Manhole	
Stormwater Pit	
Water Main	
Water Conduit	
Water Service Point of Entry	
Underground Electricity, Street Light, Electricity Pillar & NBN	
Developer Fencing	
Concrete Pathway	
Zero Setback Building Line	
Indicative Building Envelope	
Bin Pads	
Proposed Services Easement	
Indicative Parking Access Location	
Landscape Street Tree	

ADDITIONAL NOTES:

Allotments used as Multiple Residential Allotments in accordance with the approved Plan of Development may have a reduced primary road setback to 3.0metres as noted on the Plan of Development Table.

Compaction of any fill material placed on this site shall be completed to level one inspection and testing services in accordance with AS3798-2007.

Location of sewer, roofwater, stormwater, water reticulation and electricity lines, manholes and pits are those shown on engineering design drawings, supplied by Colliers and may differ from the as-constructed location.

Plan of Development information Supplied by RPS Group PLC.

Copyright © Veris Australia Pty Ltd
May 2023.

Plot Date: 19 May, 2023
 Computer File Ref: 430109_St3D-SP-B.dwg

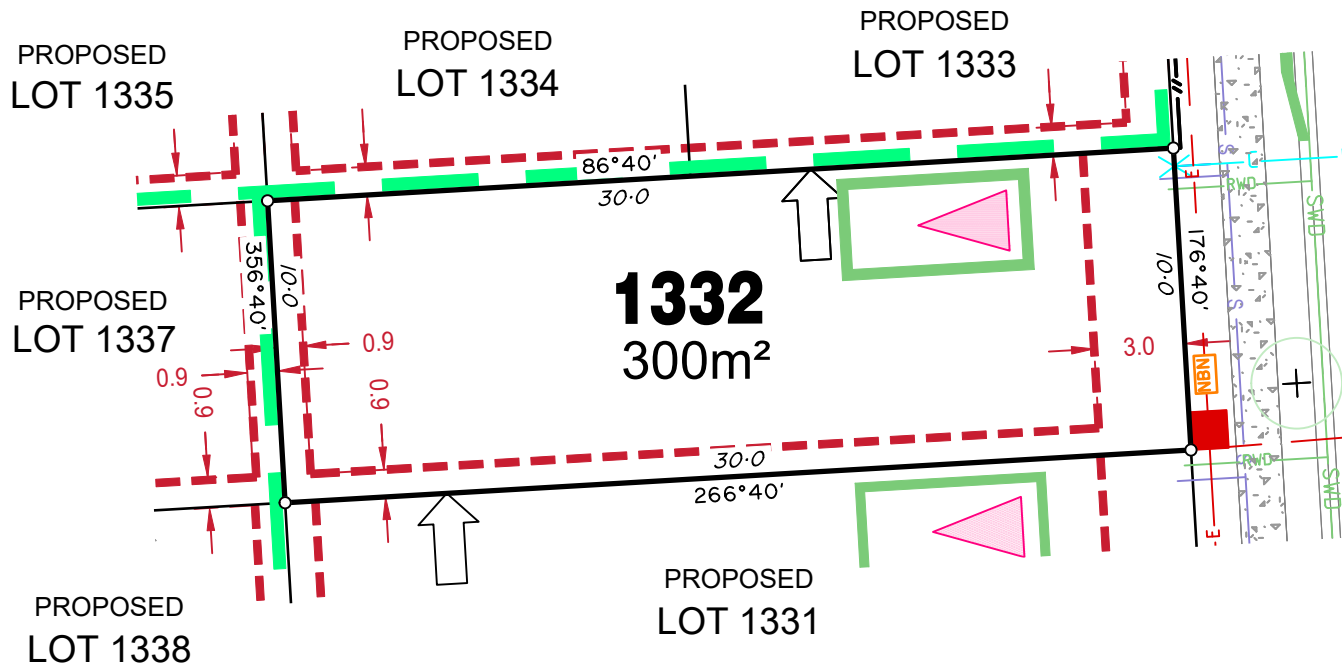

LEGEND

Rock Retaining Wall shown as:-	
Sleeper Retaining Wall shown as:-	
Landscape Retaining Wall shown as:-	
Sewer line	
Sewer Manhole	
Roofwater Drainage line and Catch Pit	
Stormwater Drainage Line	
Stormwater Manhole	
Stormwater Pit	
Water Main	
Water Conduit	
Water Service Point of Entry	
Underground Electricity, Street Light, Electricity Pillar & NBN	
Developer Fencing	
Concrete Pathway	
Zero Setback Building Line	
Landscape Street Tree	
Indicative Building Envelope	
Bin Pads	
Proposed Services Easement	
Indicative Parking Access Location	

ADDITIONAL NOTES:

Allotments used as Multiple Residential Allotments in accordance with the approved Plan of Development may have a reduced primary road setback to 3.0metres as noted on the Plan of Development Table.

Compaction of any fill material placed on this site shall be completed to level one inspection and testing services in accordance with AS3798-2007.

Location of sewer, roofwater, stormwater, water reticulation and electricity lines, manholes and pits are those shown on engineering design drawings, supplied by Colliers and may differ from the as-constructed location.

Plan of Development information Supplied by RPS Group PLC.

Copyright © Veris Australia Pty Ltd
May 2023.

Plot Date: 19 May, 2023
 Computer File Ref: 430109_S3D-SP-B.dwg

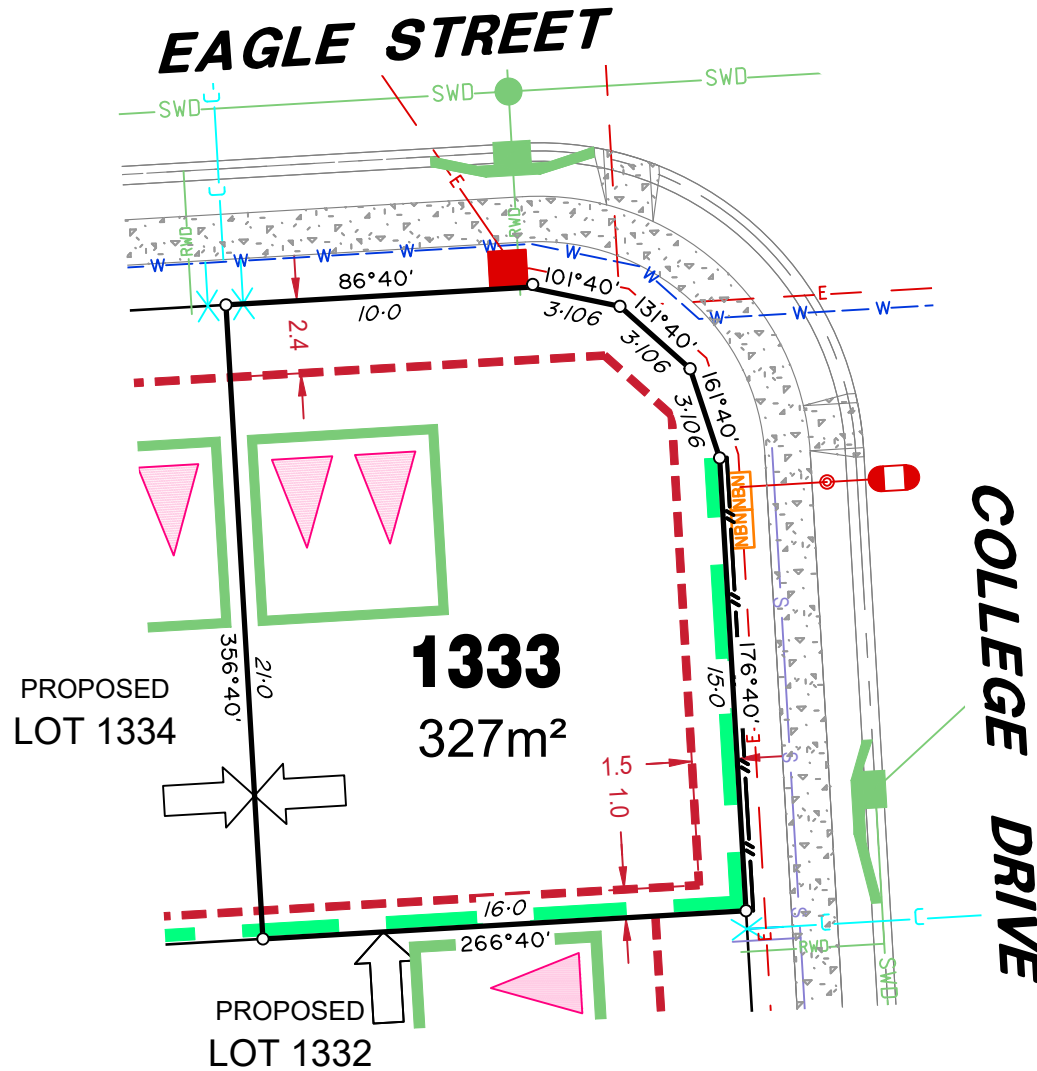

LEGEND

Rock Retaining Wall shown as:-	
Sleeper Retaining Wall shown as:-	
Landscape Retaining Wall shown as:-	
Sewer line	
Sewer Manhole	
Roofwater Drainage line and Catch Pit	
Stormwater Drainage Line	
Stormwater Manhole	
Stormwater Pit	
Water Main	
Water Conduit	
Water Service Point of Entry	
Underground Electricity, Street Light, Electricity Pillar & NBN	
Developer Fencing	
Concrete Pathway	
Landscape Street Tree	
Zero Setback Building Line	
Indicative Building Envelope	
Bin Pads	
Proposed Services Easement	
Indicative Parking Access Location	

ADDITIONAL NOTES:

Allotments used as Multiple Residential Allotments in accordance with the approved Plan of Development may have a reduced primary road setback to 3.0metres as noted on the Plan of Development Table.

Compaction of any fill material placed on this site shall be completed to level one inspection and testing services in accordance with AS3798-2007.

Location of sewer, roofwater, stormwater, water reticulation and electricity lines, manholes and pits are those shown on engineering design drawings, supplied by Colliers and may differ from the as-constructed location.

Plan of Development information Supplied by RPS Group PLC.

Copyright © Veris Australia Pty Ltd
May 2023.

Plot Date: 19 May, 2023
 Computer File Ref: 430109_St3D-SP-B.dwg



EAGLE STREET

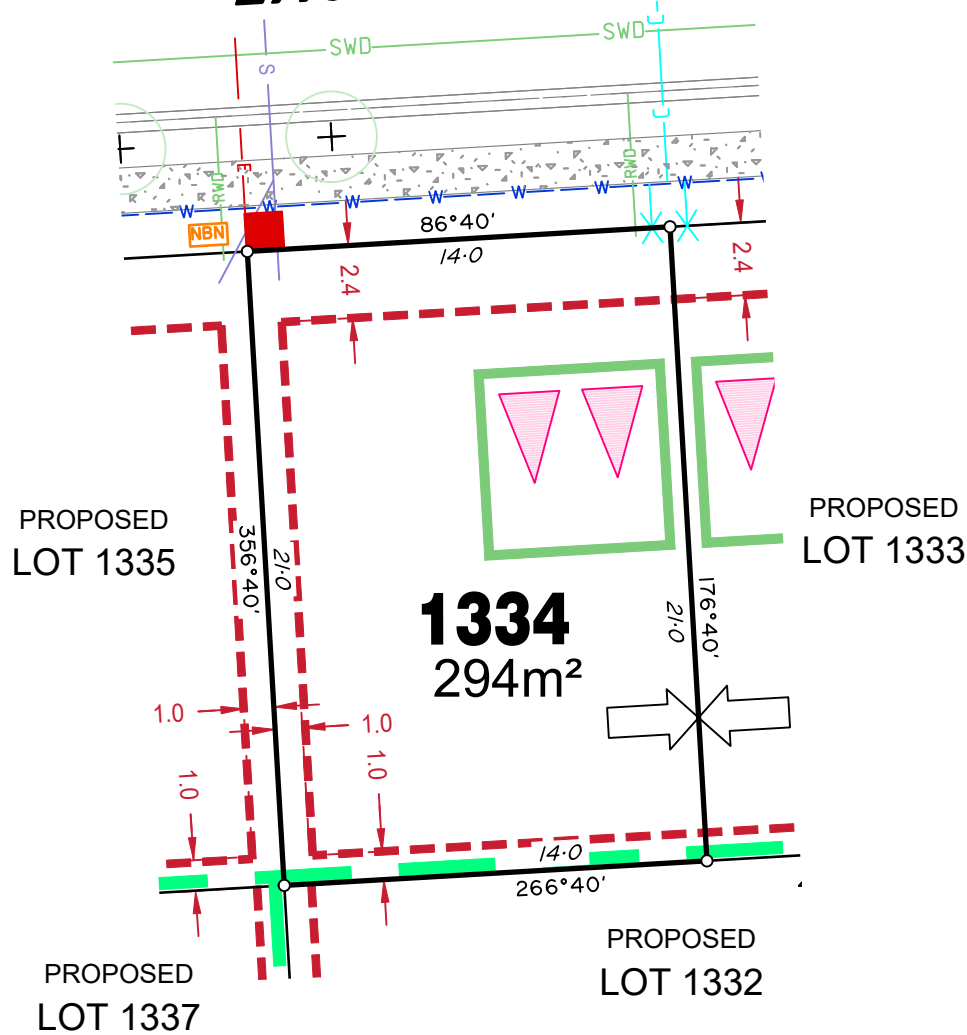

LEGEND

Rock Retaining Wall shown as:-	
Sleeper Retaining Wall shown as:-	
Landscape Retaining Wall shown as:-	
Sewer line	
Sewer Manhole	
Roofwater Drainage line and Catch Pit	
Stormwater Drainage Line	
Stormwater Manhole	
Stormwater Pit	
Water Main	
Water Conduit	
Water Service Point of Entry	
Underground Electricity, Street Light, Electricity Pillar & NBN	
Developer Fencing	
Concrete Pathway	
Landscape Street Tree	
Zero Setback Building Line	
Indicative Building Envelope	
Bin Pads	
Proposed Services Easement	
Indicative Parking Access Location	

ADDITIONAL NOTES:

Allotments used as Multiple Residential Allotments in accordance with the approved Plan of Development may have a reduced primary road setback to 3.0metres as noted on the Plan of Development Table.

Compaction of any fill material placed on this site shall be completed to level one inspection and testing services in accordance with AS3798-2007.

Location of sewer, roofwater, stormwater, water reticulation and electricity lines, manholes and pits are those shown on engineering design drawings, supplied by Colliers and may differ from the as-constructed location.

Plan of Development information Supplied by RPS Group PLC.

Copyright © Veris Australia Pty Ltd
May 2023.

Plot Date: 19 May, 2023
 Computer File Ref: 430109_St3D-SP-B.dwg



EAGLE STREET

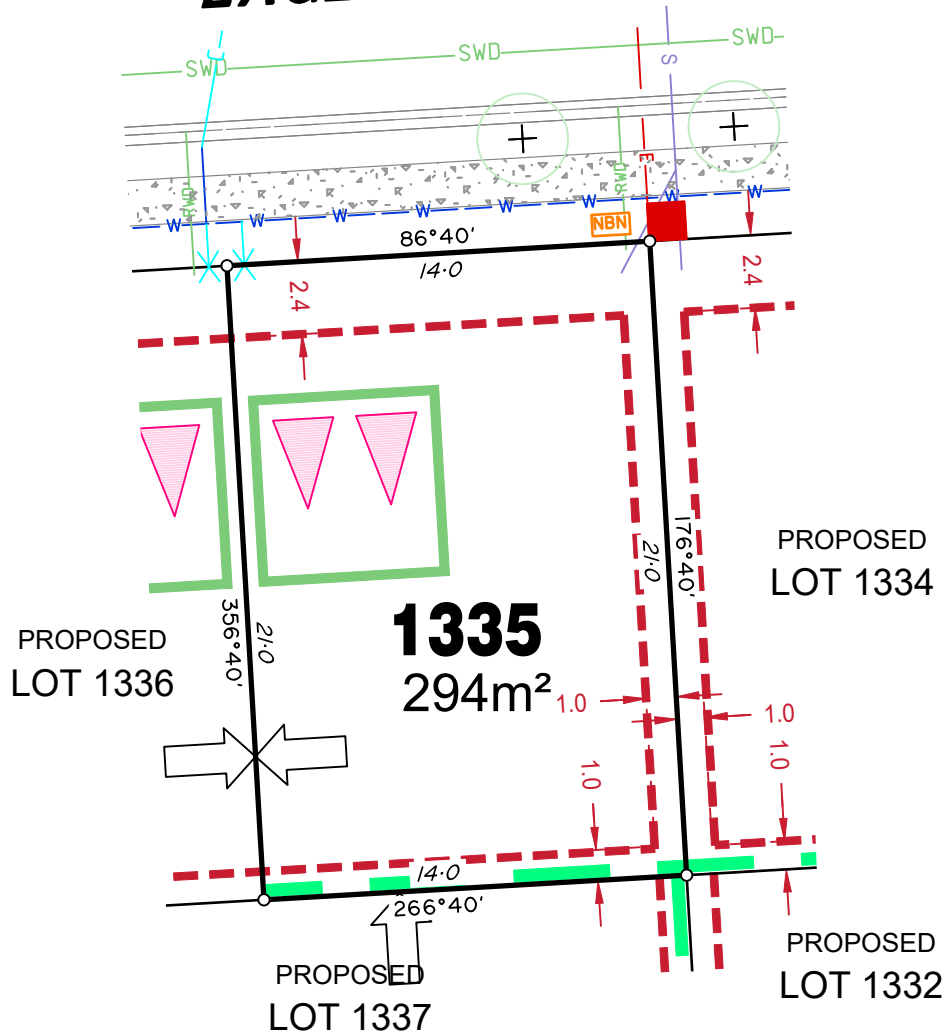

LEGEND

Rock Retaining Wall shown as:-	
Sleeper Retaining Wall shown as:-	
Landscape Retaining Wall shown as:-	
Sewer line	
Sewer Manhole	
Roofwater Drainage line and Catch Pit	
Stormwater Drainage Line	
Stormwater Manhole	
Stormwater Pit	
Water Main	
Water Conduit	
Water Service Point of Entry	
Underground Electricity, Street Light, Electricity Pillar & NBN	
Developer Fencing	
Concrete Pathway	
Landscape Street Tree	
Zero Setback Building Line	
Indicative Building Envelope	
Bin Pads	
Proposed Services Easement	
Indicative Parking Access Location	

ADDITIONAL NOTES:

Allotments used as Multiple Residential Allotments in accordance with the approved Plan of Development may have a reduced primary road setback to 3.0metres as noted on the Plan of Development Table.

Compaction of any fill material placed on this site shall be completed to level one inspection and testing services in accordance with AS3798-2007.

Location of sewer, roofwater, stormwater, water reticulation and electricity lines, manholes and pits are those shown on engineering design drawings, supplied by Colliers and may differ from the as-constructed location.

Plan of Development information Supplied by RPS Group PLC.

Copyright © Veris Australia Pty Ltd
May 2023.

Plot Date: 19 May, 2023
 Computer File Ref: 430109_S3D-SP-B.dwg

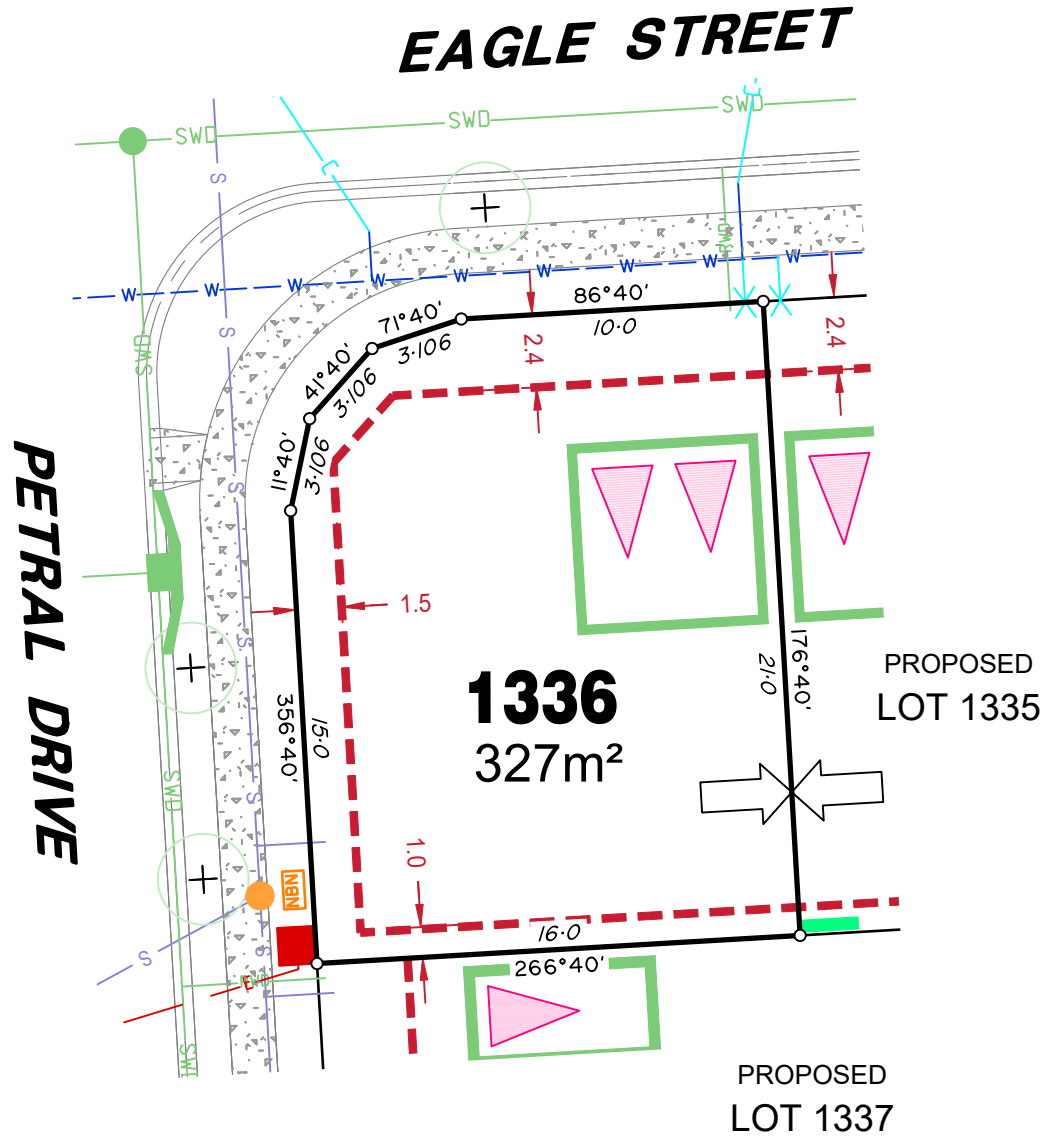

LEGEND

Rock Retaining Wall shown as:-	
Sleeper Retaining Wall shown as:-	
Landscape Retaining Wall shown as:-	
Sewer line	
Sewer Manhole	
Roofwater Drainage line and Catch Pit	
Stormwater Drainage Line	
Stormwater Manhole	
Stormwater Pit	
Water Main	
Water Conduit	
Water Service Point of Entry	
Underground Electricity, Street Light, Electricity Pillar & NBN	
Developer Fencing	
Concrete Pathway	
Zero Setback Building Line	
Landscape Street Tree	
Indicative Building Envelope	
Bin Pads	
Proposed Services Easement	
Indicative Parking Access Location	

ADDITIONAL NOTES:

Allotments used as Multiple Residential Allotments in accordance with the approved Plan of Development may have a reduced primary road setback to 3.0metres as noted on the Plan of Development Table.

Compaction of any fill material placed on this site shall be completed to level one inspection and testing services in accordance with AS3798-2007.

Location of sewer, roofwater, stormwater, water reticulation and electricity lines, manholes and pits are those shown on engineering design drawings, supplied by Colliers and may differ from the as-constructed location.

Plan of Development information Supplied by RPS Group PLC.

Copyright © Veris Australia Pty Ltd
May 2023.

Plot Date: 19 May, 2023
 Computer File Ref: 430109_S3D-SP-B.dwg



PETRAL DRIVE

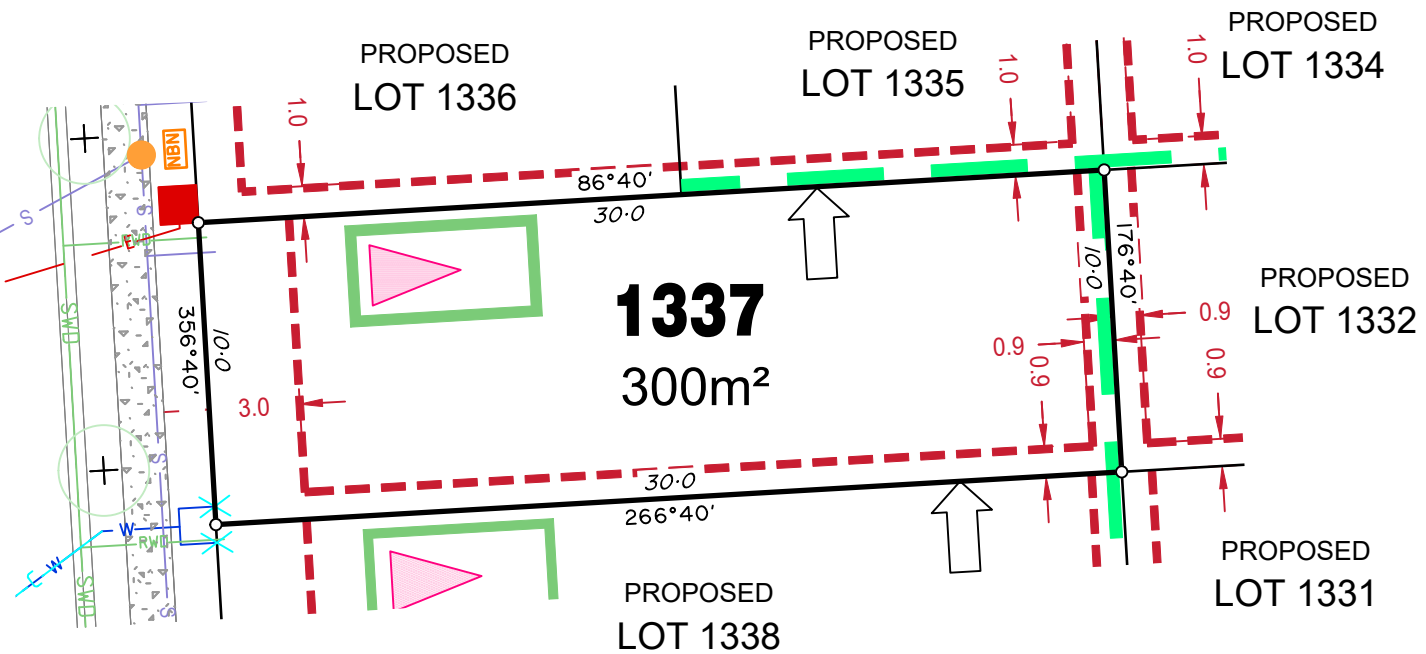

LEGEND

Rock Retaining Wall shown as:-	
Sleeper Retaining Wall shown as:-	
Landscape Retaining Wall shown as:-	
Sewer line	
Sewer Manhole	
Roofwater Drainage line and Catch Pit	
Stormwater Drainage Line	
Stormwater Manhole	
Stormwater Pit	
Water Main	
Water Conduit	
Water Service Point of Entry	
Underground Electricity, Street Light, Electricity Pillar & NBN	
Developer Fencing	
Concrete Pathway	
Landscape Street Tree	
Zero Setback Building Line	
Indicative Building Envelope	
Bin Pads	
Proposed Services Easement	
Indicative Parking Access Location	

ADDITIONAL NOTES:

Allotments used as Multiple Residential Allotments in accordance with the approved Plan of Development may have a reduced primary road setback to 3.0metres as noted on the Plan of Development Table.

Compaction of any fill material placed on this site shall be completed to level one inspection and testing services in accordance with AS3798-2007.

Location of sewer, roofwater, stormwater, water reticulation and electricity lines, manholes and pits are those shown on engineering design drawings, supplied by Colliers and may differ from the as-constructed location.

Plan of Development information Supplied by RPS Group PLC.

Copyright © Veris Australia Pty Ltd
May 2023.

Plot Date: 19 May, 2023
 Computer File Ref: 430109_S3D-SP-B.dwg



PETRAL DRIVE

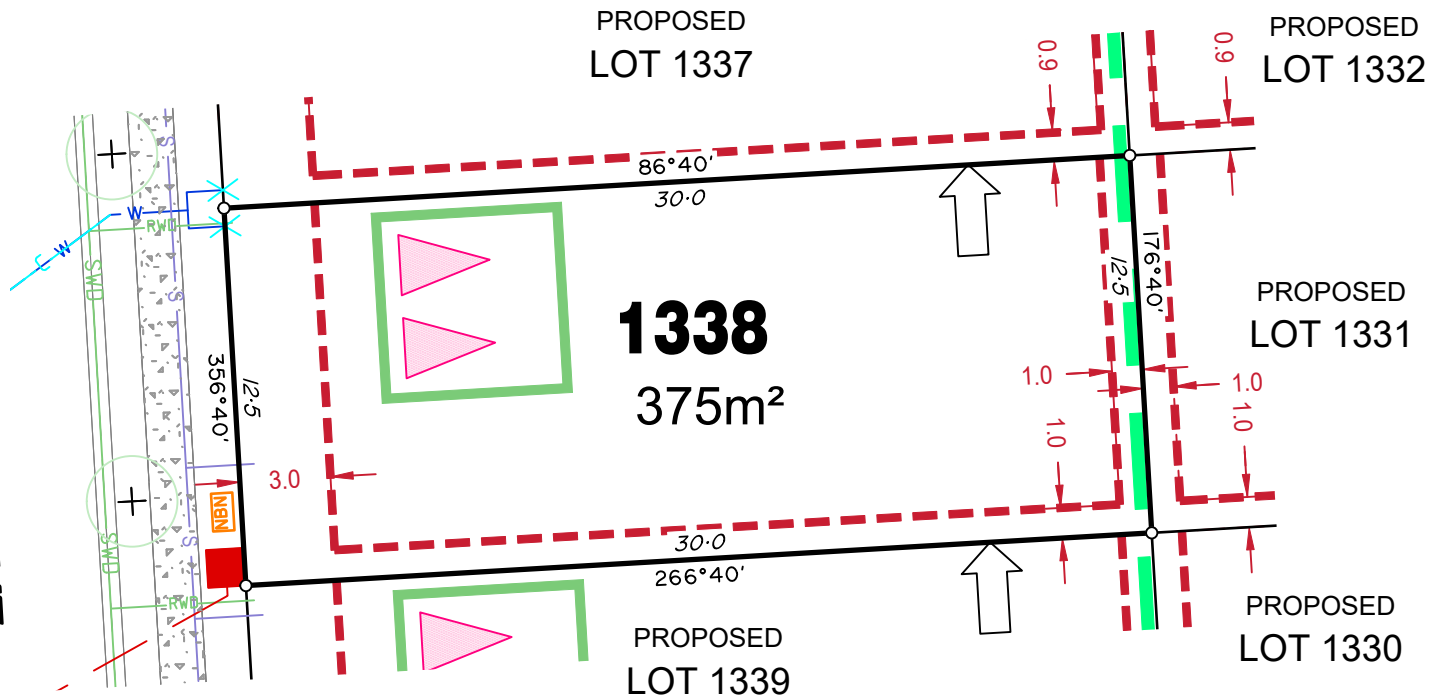

LEGEND

Rock Retaining Wall shown as:-	
Sleeper Retaining Wall shown as:-	
Landscape Retaining Wall shown as:-	
Sewer line	
Sewer Manhole	
Roofwater Drainage line and Catch Pit	
Stormwater Drainage Line	
Stormwater Manhole	
Stormwater Pit	
Water Main	
Water Conduit	
Water Service Point of Entry	
Underground Electricity, Street Light, Electricity Pillar & NBN	
Developer Fencing	
Concrete Pathway	
Zero Setback Building Line	
Indicative Building Envelope	
Bin Pads	
Proposed Services Easement	
Indicative Parking Access Location	

ADDITIONAL NOTES:

Allotments used as Multiple Residential Allotments in accordance with the approved Plan of Development may have a reduced primary road setback to 3.0metres as noted on the Plan of Development Table.

Compaction of any fill material placed on this site shall be completed to level one inspection and testing services in accordance with AS3798-2007.

Location of sewer, roofwater, stormwater, water reticulation and electricity lines, manholes and pits are those shown on engineering design drawings, supplied by Colliers and may differ from the as-constructed location.

Plan of Development information Supplied by RPS Group PLC.

Copyright © Veris Australia Pty Ltd
May 2023.

Plot Date: 19 May, 2023
 Computer File Ref: 430109_S3D-SP-B.dwg



PETRAL DRIVE

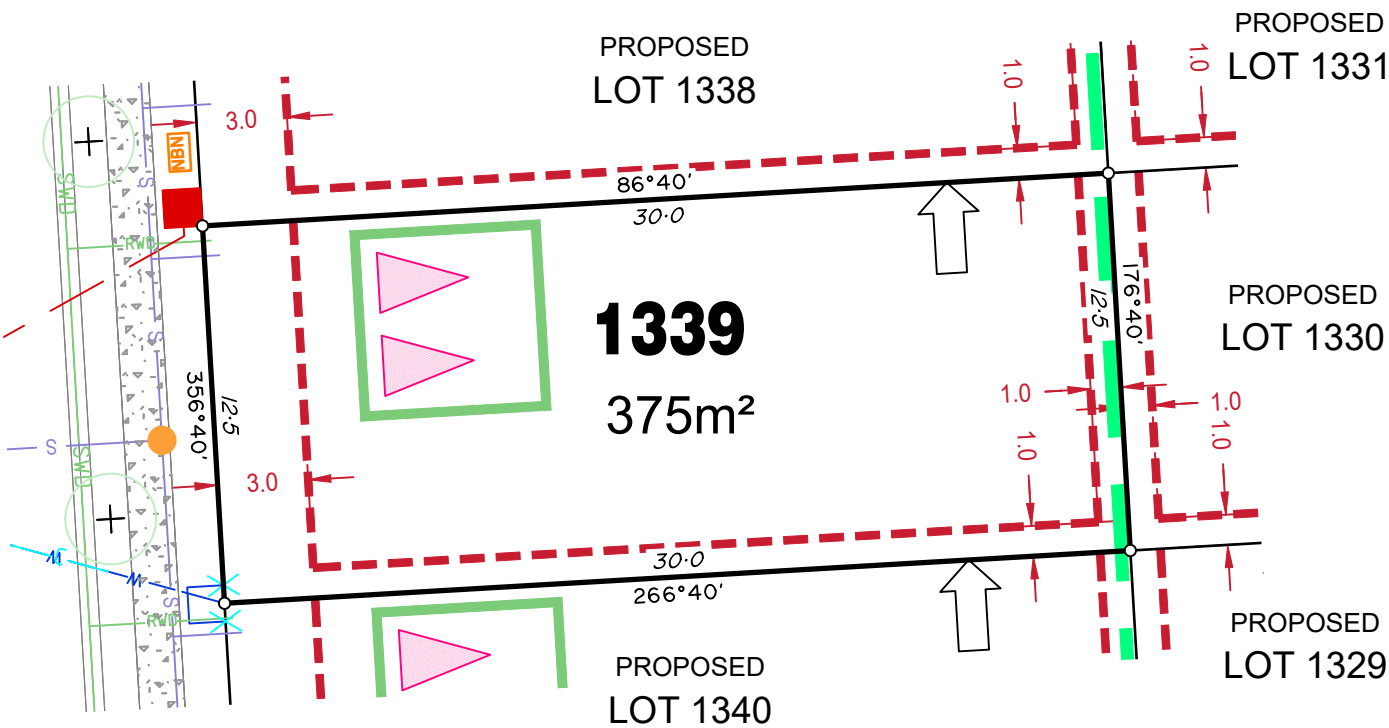

LEGEND

Rock Retaining Wall shown as:-	
Sleeper Retaining Wall shown as:-	
Landscape Retaining Wall shown as:-	
Sewer line	
Sewer Manhole	
Roofwater Drainage line and Catch Pit	
Stormwater Drainage Line	
Stormwater Manhole	
Stormwater Pit	
Water Main	
Water Conduit	
Water Service Point of Entry	
Underground Electricity, Street Light, Electricity Pillar & NBN	
Developer Fencing	
Concrete Pathway	
Landscape Street Tree	
Zero Setback Building Line	
Indicative Building Envelope	
Bin Pads	
Proposed Services Easement	
Indicative Parking Access Location	

ADDITIONAL NOTES:

Allotments used as Multiple Residential Allotments in accordance with the approved Plan of Development may have a reduced primary road setback to 3.0metres as noted on the Plan of Development Table.

Compaction of any fill material placed on this site shall be completed to level one inspection and testing services in accordance with AS3798-2007.

Location of sewer, roofwater, stormwater, water reticulation and electricity lines, manholes and pits are those shown on engineering design drawings, supplied by Colliers and may differ from the as-constructed location.

Plan of Development information Supplied by RPS Group PLC.

Copyright © Veris Australia Pty Ltd
May 2023.

Plot Date: 19 May, 2023
 Computer File Ref: 430109_S3D-SP-B.dwg



PETRAL DRIVE

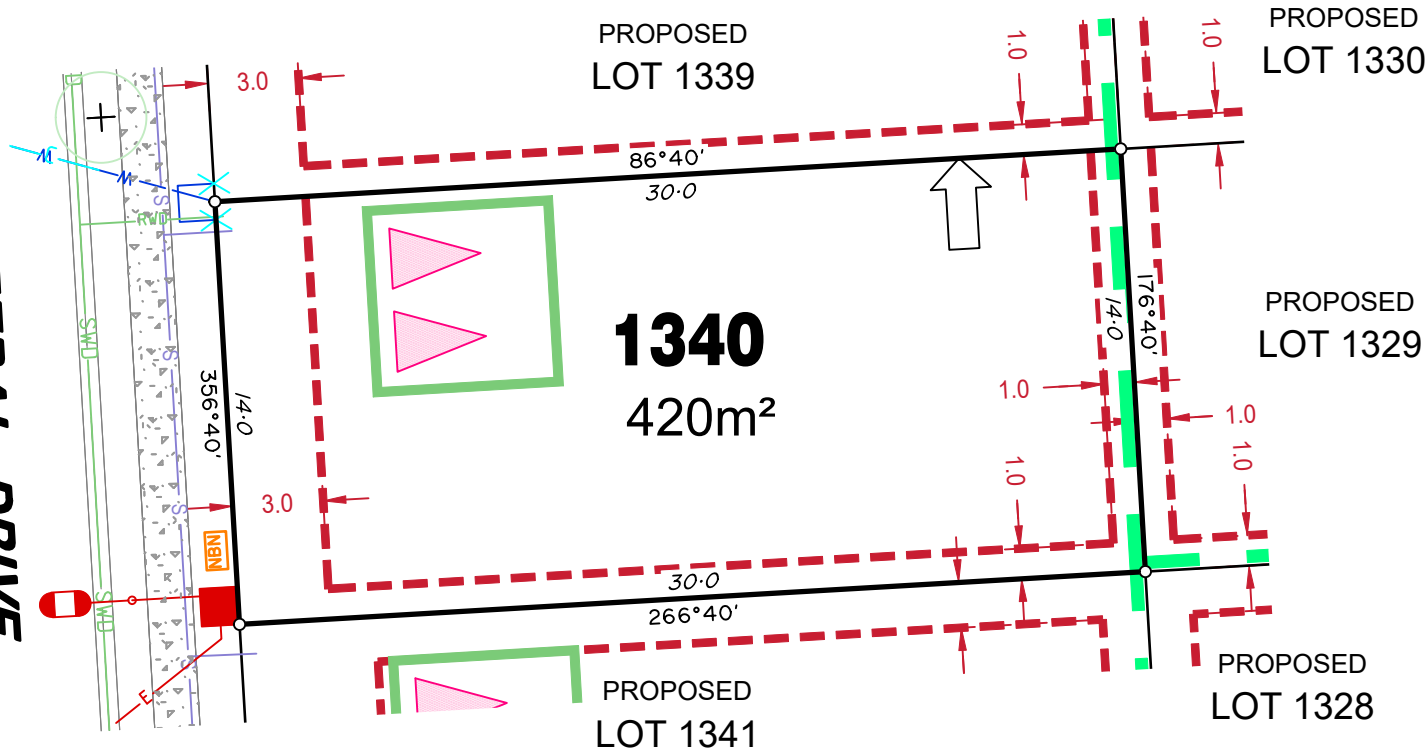

LEGEND

Rock Retaining Wall shown as:-	
Sleeper Retaining Wall shown as:-	
Landscape Retaining Wall shown as:-	
Sewer line	
Sewer Manhole	
Roofwater Drainage line and Catch Pit	
Stormwater Drainage Line	
Stormwater Manhole	
Stormwater Pit	
Water Main	
Water Conduit	
Water Service Point of Entry	
Underground Electricity, Street Light, Electricity Pillar & NBN	
Developer Fencing	
Concrete Pathway	
Zero Setback Building Line	
Landscape Street Tree	
Indicative Building Envelope	
Bin Pads	
Proposed Services Easement	
Indicative Parking Access Location	

ADDITIONAL NOTES:

Allotments used as Multiple Residential Allotments in accordance with the approved Plan of Development may have a reduced primary road setback to 3.0metres as noted on the Plan of Development Table.

Compaction of any fill material placed on this site shall be completed to level one inspection and testing services in accordance with AS3798-2007.

Location of sewer, roofwater, stormwater, water reticulation and electricity lines, manholes and pits are those shown on engineering design drawings, supplied by Colliers and may differ from the as-constructed location.

Plan of Development information Supplied by RPS Group PLC.

Copyright © Veris Australia Pty Ltd
May 2023.

Plot Date: 19 May, 2023
 Computer File Ref: 430109_S3D-SP-B.dwg



PETRAL DRIVE

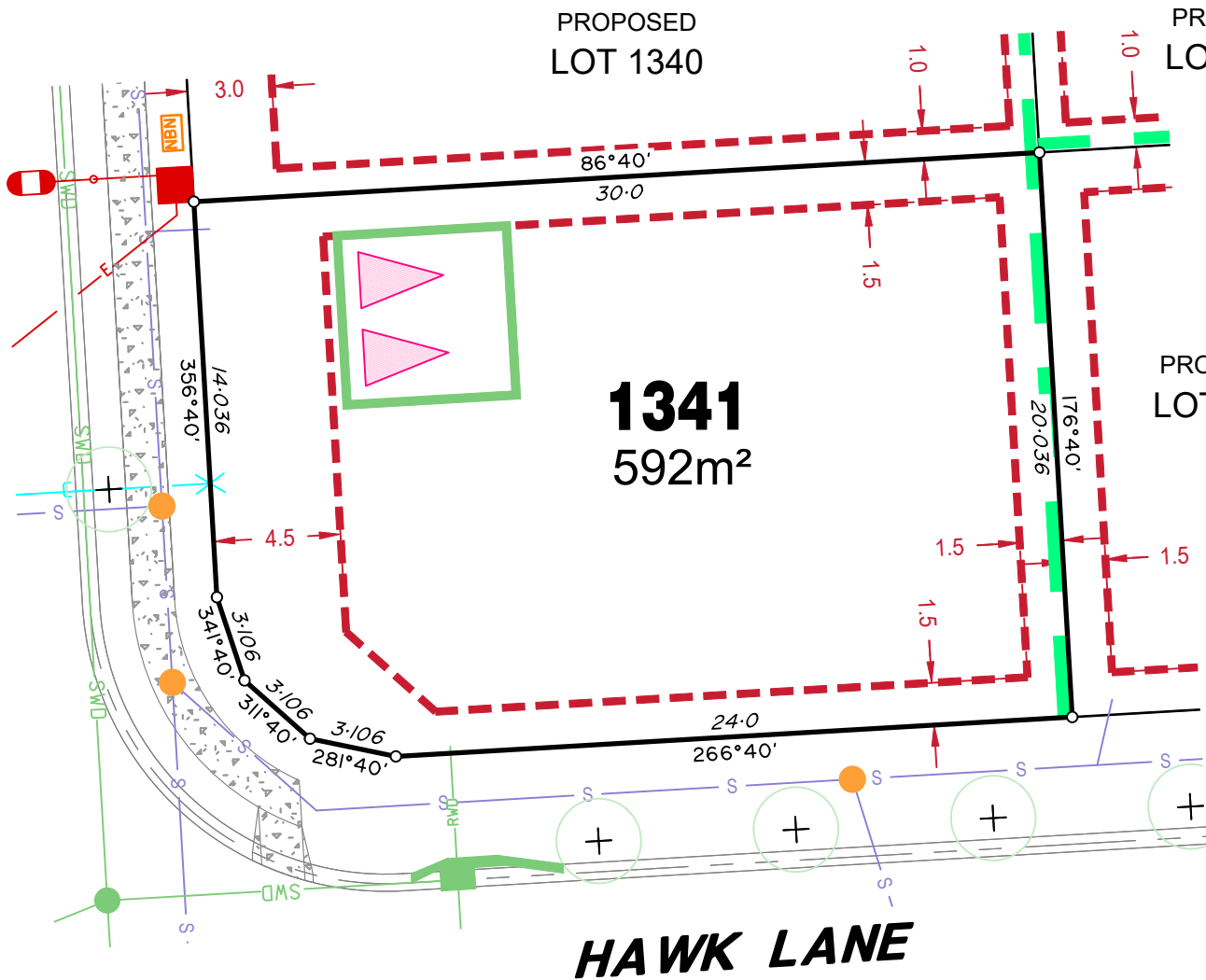

LEGEND

Rock Retaining Wall shown as:-	
Sleeper Retaining Wall shown as:-	
Landscape Retaining Wall shown as:-	
Sewer line	
Sewer Manhole	
Roofwater Drainage line and Catch Pit	
Stormwater Drainage Line	
Stormwater Manhole	
Stormwater Pit	
Water Main	
Water Conduit	
Water Service Point of Entry	
Underground Electricity, Street Light, Electricity Pillar & NBN	
Developer Fencing	
Concrete Pathway	
Zero Setback Building Line	
Landscape Street Tree	
Indicative Building Envelope	
Bin Pads	
Proposed Services Easement	
Indicative Parking Access Location	

ADDITIONAL NOTES:

Allotments used as Multiple Residential Allotments in accordance with the approved Plan of Development may have a reduced primary road setback to 3.0metres as noted on the Plan of Development Table.

Compaction of any fill material placed on this site shall be completed to level one inspection and testing services in accordance with AS3798-2007.

Location of sewer, roofwater, stormwater, water reticulation and electricity lines, manholes and pits are those shown on engineering design drawings, supplied by Colliers and may differ from the as-constructed location.

Plan of Development information Supplied by RPS Group PLC.

Copyright © Veris Australia Pty Ltd
May 2023.

Plot Date: 19 May, 2023
Computer File Ref: 430109_St3D-SP-B.dwg

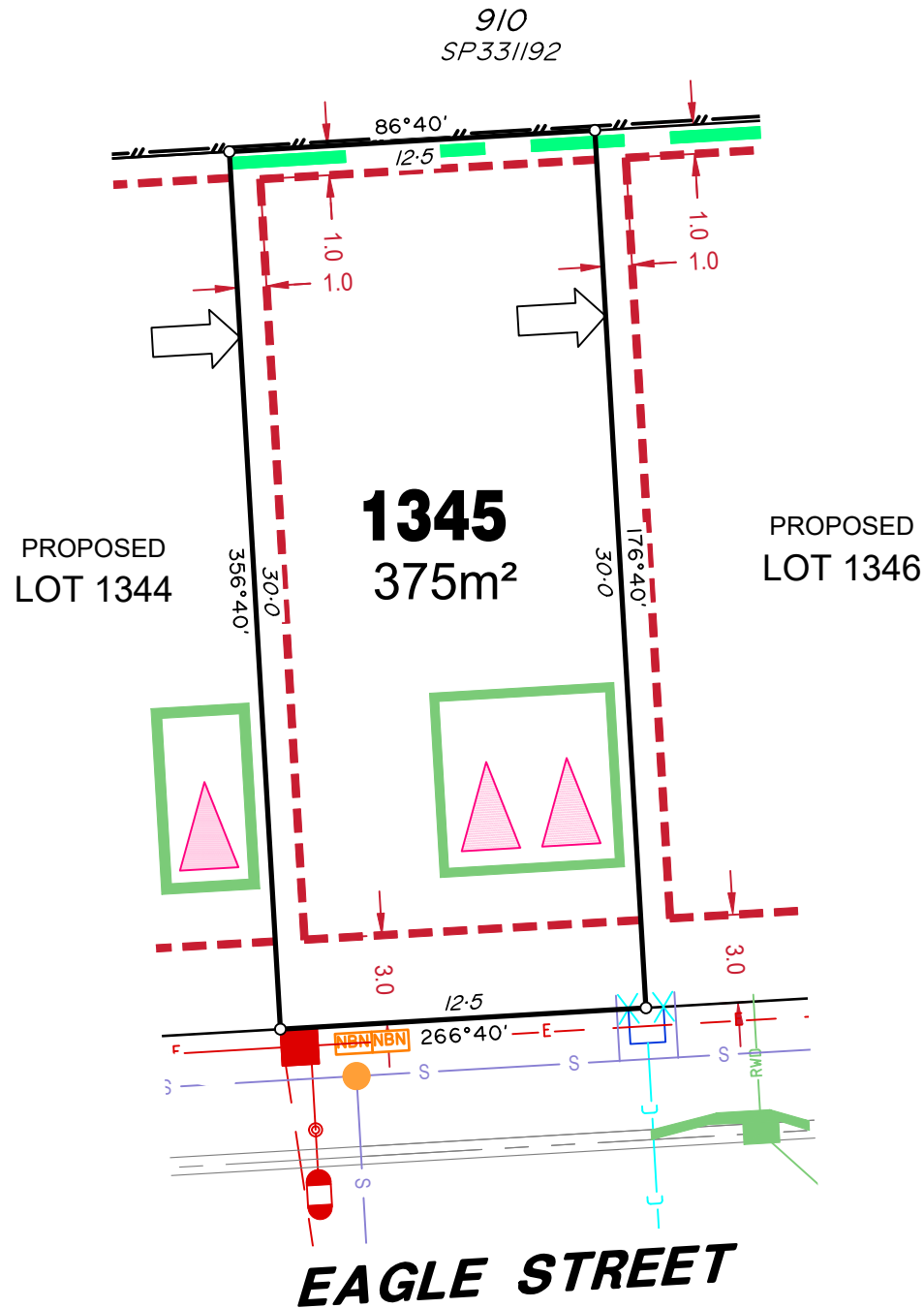

LEGEND

Rock Retaining Wall shown as:-	
Sleeper Retaining Wall shown as:-	
Landscape Retaining Wall shown as:-	
Sewer line	
Sewer Manhole	
Roofwater Drainage line and Catch Pit	
Stormwater Drainage Line	
Stormwater Manhole	
Stormwater Pit	
Water Main	
Water Conduit	
Water Service Point of Entry	
Underground Electricity, Street Light, Electricity Pillar & NBN	
Developer Fencing	
Concrete Pathway	
Landscape Street Tree	
Zero Setback Building Line	
Indicative Building Envelope	
Bin Pads	
Proposed Services Easement	
Indicative Parking Access Location	

ADDITIONAL NOTES:

Allotments used as Multiple Residential Allotments in accordance with the approved Plan of Development may have a reduced primary road setback to 3.0metres as noted on the Plan of Development Table.

Compaction of any fill material placed on this site shall be completed to level one inspection and testing services in accordance with AS3798-2007.

Location of sewer, roofwater, stormwater, water reticulation and electricity lines, manholes and pits are those shown on engineering design drawings, supplied by Colliers and may differ from the as-constructed location.

Plan of Development information Supplied by RPS Group PLC.

Copyright © Veris Australia Pty Ltd
May 2023.

Plot Date: 19 May, 2023
Computer File Ref: 430109_St3D-SP-B.dwg

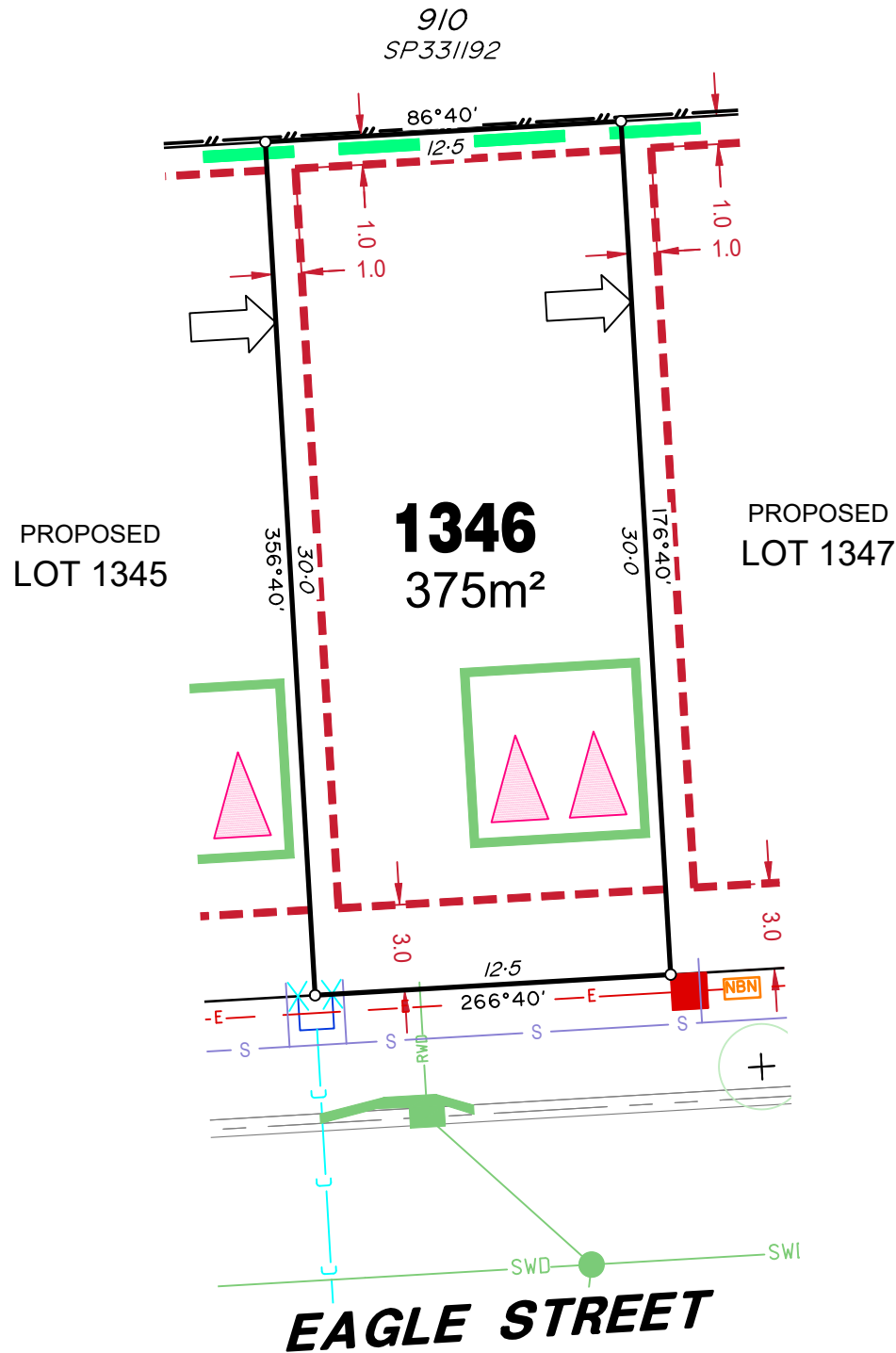

LEGEND

Rock Retaining Wall shown as:-	
Sleeper Retaining Wall shown as:-	
Landscape Retaining Wall shown as:-	
Sewer line	
Sewer Manhole	
Roofwater Drainage line and Catch Pit	
Stormwater Drainage Line	
Stormwater Manhole	
Stormwater Pit	
Water Main	
Water Conduit	
Water Service Point of Entry	
Underground Electricity, Street Light, Electricity Pillar & NBN	
Developer Fencing	
Concrete Pathway	
Landscape Street Tree	
Zero Setback Building Line	
Indicative Building Envelope	
Bin Pads	
Proposed Services Easement	
Indicative Parking Access Location	

ADDITIONAL NOTES:

Allotments used as Multiple Residential Allotments in accordance with the approved Plan of Development may have a reduced primary road setback to 3.0metres as noted on the Plan of Development Table.

Compaction of any fill material placed on this site shall be completed to level one inspection and testing services in accordance with AS3798-2007.

Location of sewer, roofwater, stormwater, water reticulation and electricity lines, manholes and pits are those shown on engineering design drawings, supplied by Colliers and may differ from the as-constructed location.

Plan of Development information Supplied by RPS Group PLC.

Copyright © Veris Australia Pty Ltd
May 2023.

Plot Date: 19 May, 2023
 Computer File Ref: 430109_S3D-SP-B.dwg

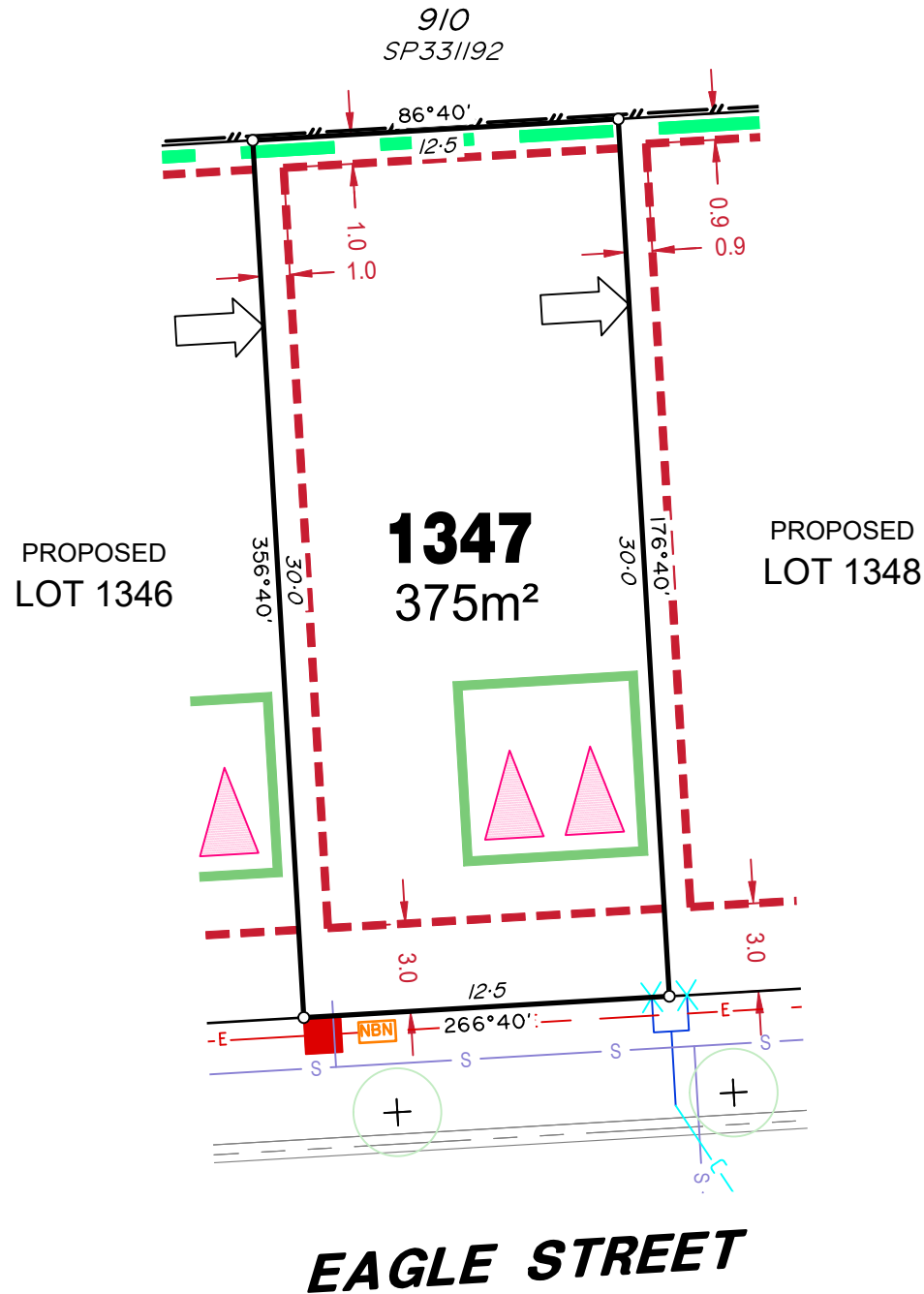

LEGEND

Rock Retaining Wall shown as:-	
Sleeper Retaining Wall shown as:-	
Landscape Retaining Wall shown as:-	
Sewer line	
Sewer Manhole	
Roofwater Drainage line and Catch Pit	
Stormwater Drainage Line	
Stormwater Manhole	
Stormwater Pit	
Water Main	
Water Conduit	
Water Service Point of Entry	
Underground Electricity, Street Light, Electricity Pillar & NBN	
Developer Fencing	
Concrete Pathway	
Landscape Street Tree	
Zero Setback Building Line	
Indicative Building Envelope	
Bin Pads	
Proposed Services Easement	
Indicative Parking Access Location	

ADDITIONAL NOTES:

Allotments used as Multiple Residential Allotments in accordance with the approved Plan of Development may have a reduced primary road setback to 3.0metres as noted on the Plan of Development Table.

Compaction of any fill material placed on this site shall be completed to level one inspection and testing services in accordance with AS3798-2007.

Location of sewer, roofwater, stormwater, water reticulation and electricity lines, manholes and pits are those shown on engineering design drawings, supplied by Colliers and may differ from the as-constructed location.

Plan of Development information Supplied by RPS Group PLC.

Copyright © Veris Australia Pty Ltd
May 2023.

Plot Date: 19 May, 2023
 Computer File Ref: 430109_S3D-SP-B.dwg

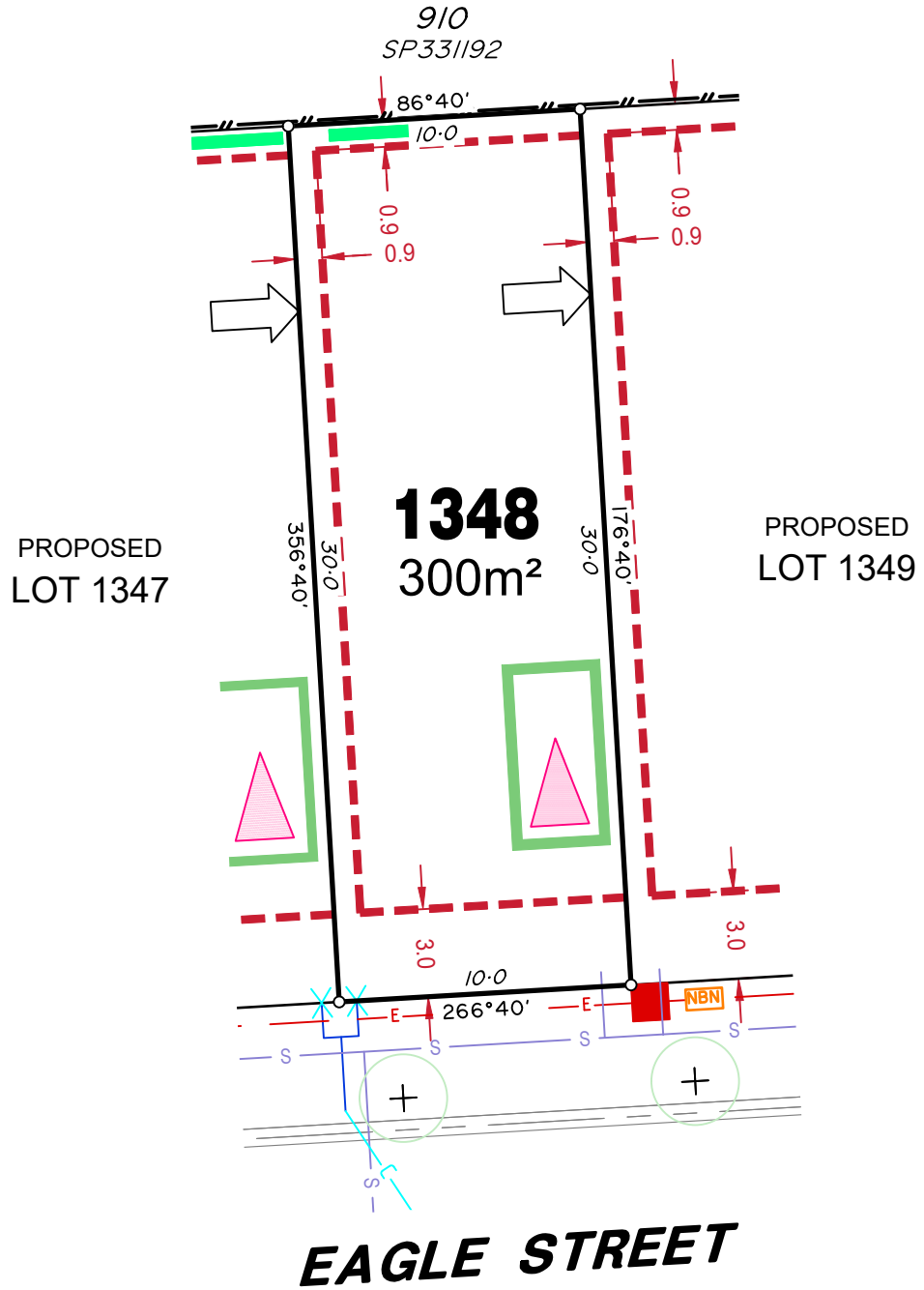

LEGEND

Rock Retaining Wall shown as:-	
Sleeper Retaining Wall shown as:-	
Landscape Retaining Wall shown as:-	
Sewer line	
Sewer Manhole	
Roofwater Drainage line and Catch Pit	
Stormwater Drainage Line	
Stormwater Manhole	
Stormwater Pit	
Water Main	
Water Conduit	
Water Service Point of Entry	
Underground Electricity, Street Light, Electricity Pillar & NBN	
Developer Fencing	
Concrete Pathway	
Landscape Street Tree	
Zero Setback Building Line	
Indicative Building Envelope	
Bin Pads	
Proposed Services Easement	
Indicative Parking Access Location	

ADDITIONAL NOTES:

Allotments used as Multiple Residential Allotments in accordance with the approved Plan of Development may have a reduced primary road setback to 3.0metres as noted on the Plan of Development Table.

Compaction of any fill material placed on this site shall be completed to level one inspection and testing services in accordance with AS3798-2007.

Location of sewer, roofwater, stormwater, water reticulation and electricity lines, manholes and pits are those shown on engineering design drawings, supplied by Colliers and may differ from the as-constructed location.

Plan of Development information Supplied by RPS Group PLC.

Copyright © Veris Australia Pty Ltd
May 2023.

Plot Date: 19 May, 2023
 Computer File Ref: 430109_S3D-SP-B.dwg

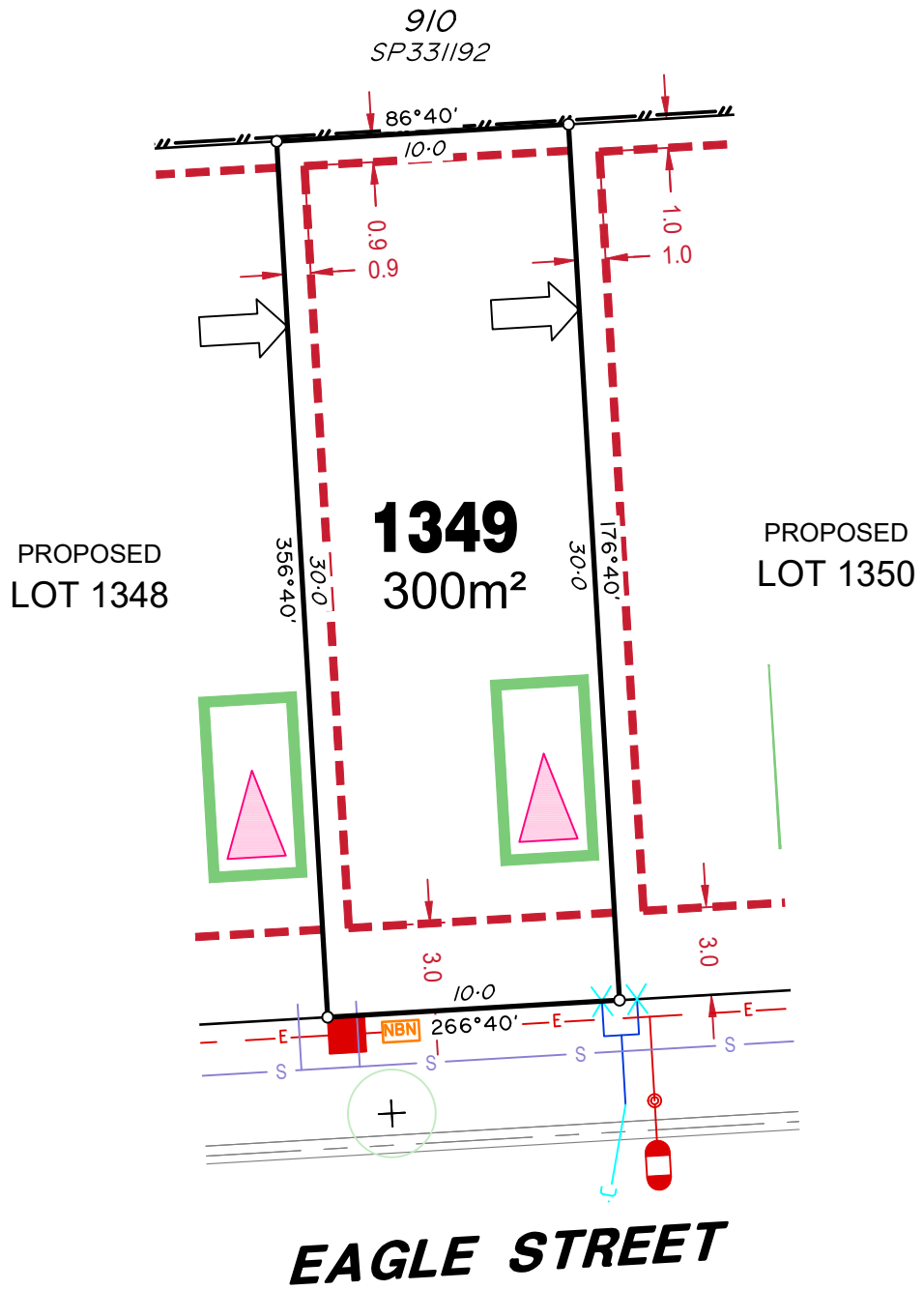

LEGEND

Rock Retaining Wall shown as:-	
Sleeper Retaining Wall shown as:-	
Landscape Retaining Wall shown as:-	
Sewer line	
Sewer Manhole	
Roofwater Drainage line and Catch Pit	
Stormwater Drainage Line	
Stormwater Manhole	
Stormwater Pit	
Water Main	
Water Conduit	
Water Service Point of Entry	
Underground Electricity, Street Light, Electricity Pillar & NBN	
Developer Fencing	
Concrete Pathway	
Landscape Street Tree	
Zero Setback Building Line	
Indicative Building Envelope	
Bin Pads	
Proposed Services Easement	
Indicative Parking Access Location	

ADDITIONAL NOTES:

Allotments used as Multiple Residential Allotments in accordance with the approved Plan of Development may have a reduced primary road setback to 3.0metres as noted on the Plan of Development Table.

Compaction of any fill material placed on this site shall be completed to level one inspection and testing services in accordance with AS3798-2007.

Location of sewer, roofwater, stormwater, water reticulation and electricity lines, manholes and pits are those shown on engineering design drawings, supplied by Colliers and may differ from the as-constructed location.

Plan of Development information Supplied by RPS Group PLC.

Copyright © Veris Australia Pty Ltd
May 2023.

Plot Date: 19 May, 2023
 Computer File Ref: 430109_St3D-SP-B.dwg

EAGLE STREET

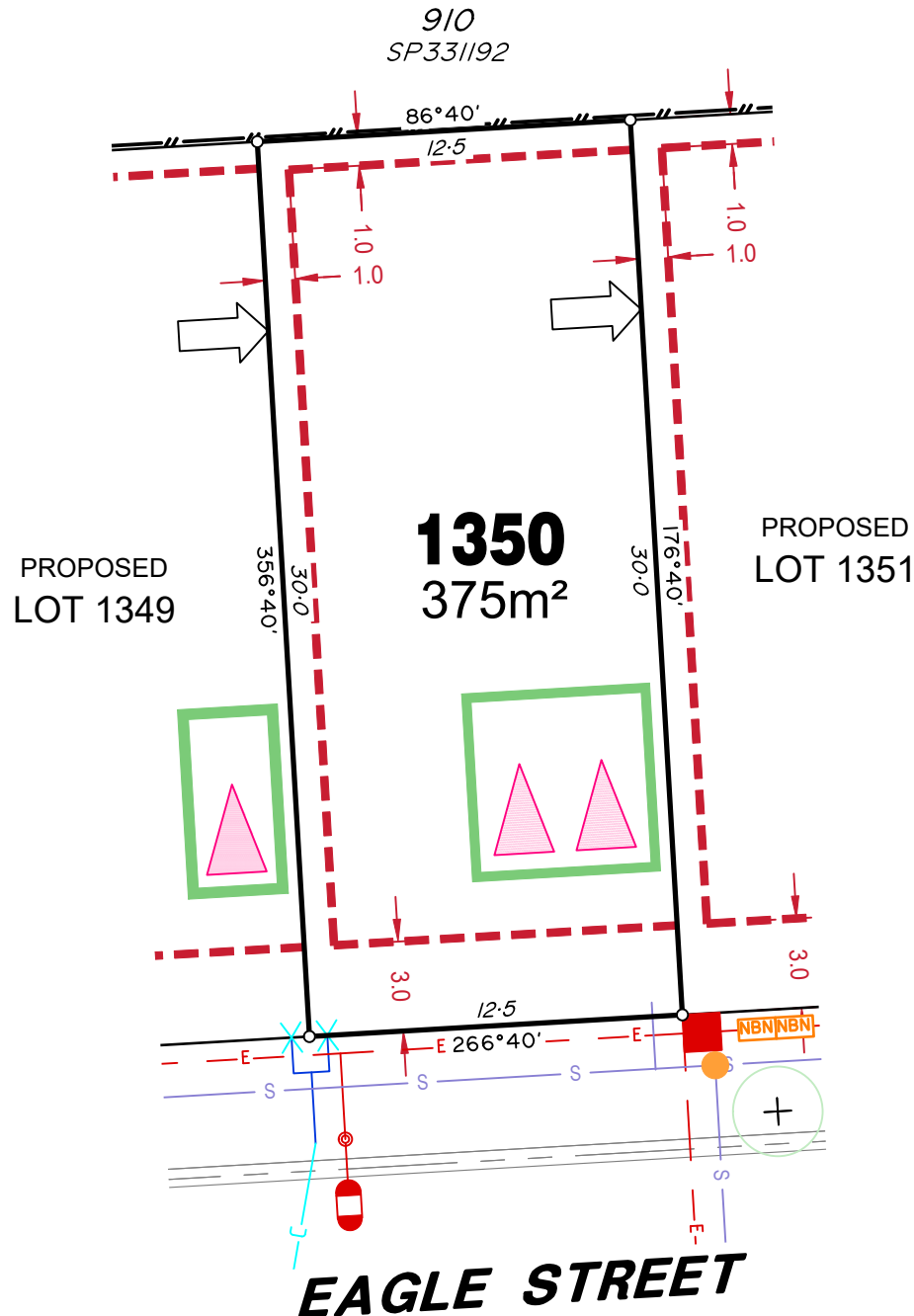

LEGEND

Rock Retaining Wall shown as:-	
Sleeper Retaining Wall shown as:-	
Landscape Retaining Wall shown as:-	
Sewer line	
Sewer Manhole	
Roofwater Drainage line and Catch Pit	
Stormwater Drainage Line	
Stormwater Manhole	
Stormwater Pit	
Water Main	
Water Conduit	
Water Service Point of Entry	
Underground Electricity, Street Light, Electricity Pillar & NBN	
Developer Fencing	
Concrete Pathway	
Landscape Street Tree	
Zero Setback Building Line	
Indicative Building Envelope	
Bin Pads	
Proposed Services Easement	
Indicative Parking Access Location	

ADDITIONAL NOTES:

Allotments used as Multiple Residential Allotments in accordance with the approved Plan of Development may have a reduced primary road setback to 3.0metres as noted on the Plan of Development Table.

Compaction of any fill material placed on this site shall be completed to level one inspection and testing services in accordance with AS3798-2007.

Location of sewer, roofwater, stormwater, water reticulation and electricity lines, manholes and pits are those shown on engineering design drawings, supplied by Colliers and may differ from the as-constructed location.

Plan of Development information Supplied by RPS Group PLC.

Copyright © Veris Australia Pty Ltd
May 2023.

Plot Date: 19 May, 2023
 Computer File Ref: 430109_S3D-SP-B.dwg

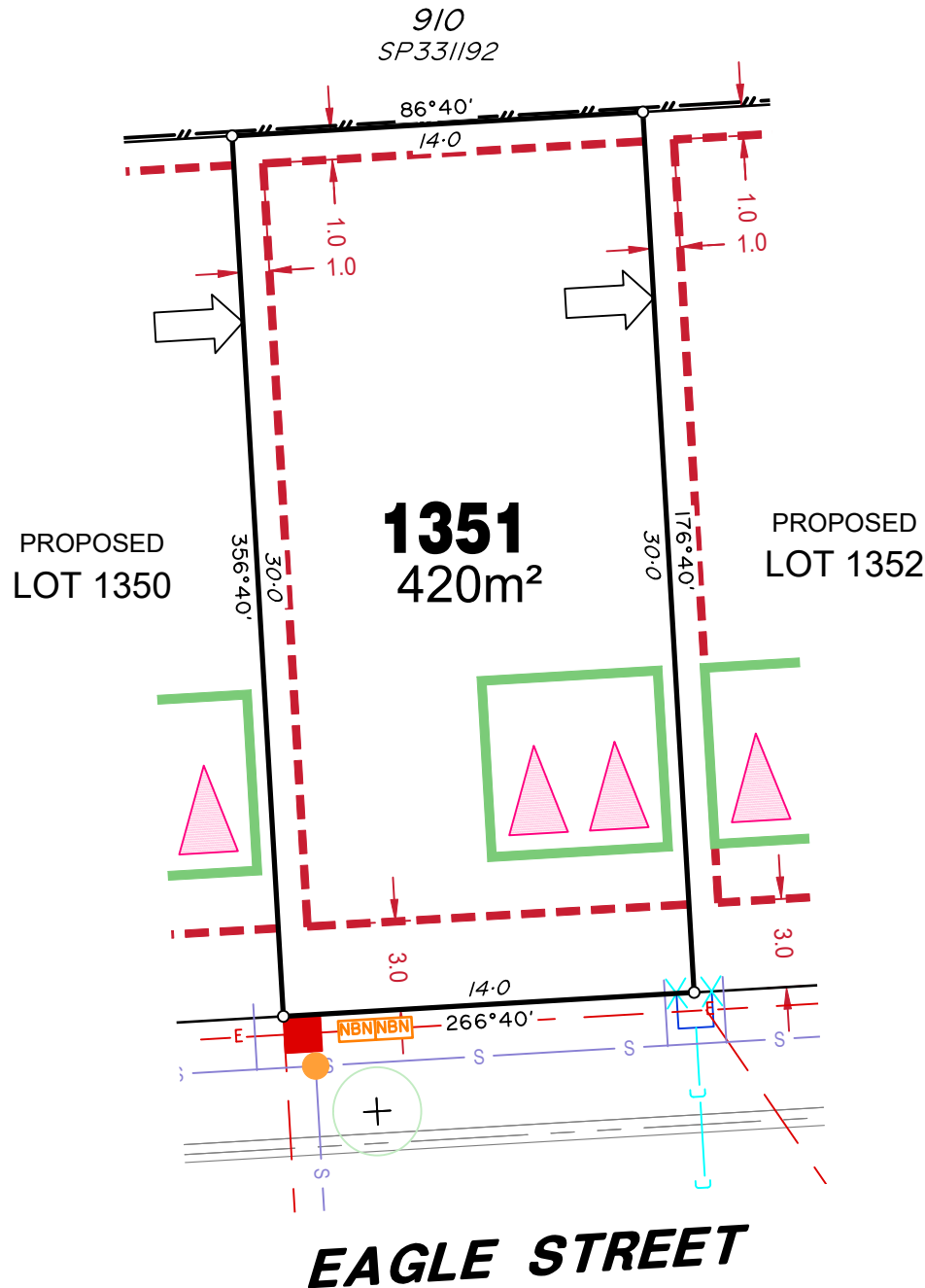

LEGEND

Rock Retaining Wall shown as:-	
Sleeper Retaining Wall shown as:-	
Landscape Retaining Wall shown as:-	
Sewer line	
Sewer Manhole	
Roofwater Drainage line and Catch Pit	
Stormwater Drainage Line	
Stormwater Manhole	
Stormwater Pit	
Water Main	
Water Conduit	
Water Service Point of Entry	
Underground Electricity, Street Light, Electricity Pillar & NBN	
Developer Fencing	
Concrete Pathway	
Landscape Street Tree	
Zero Setback Building Line	
Indicative Building Envelope	
Bin Pads	
Proposed Services Easement	
Indicative Parking Access Location	

ADDITIONAL NOTES:

Allotments used as Multiple Residential Allotments in accordance with the approved Plan of Development may have a reduced primary road setback to 3.0metres as noted on the Plan of Development Table.

Compaction of any fill material placed on this site shall be completed to level one inspection and testing services in accordance with AS3798-2007.

Location of sewer, roofwater, stormwater, water reticulation and electricity lines, manholes and pits are those shown on engineering design drawings, supplied by Colliers and may differ from the as-constructed location.

Plan of Development information Supplied by RPS Group PLC.

Copyright © Veris Australia Pty Ltd
May 2023.

Plot Date: 19 May, 2023
Computer File Ref: 430109_S3D-SP-B.dwg

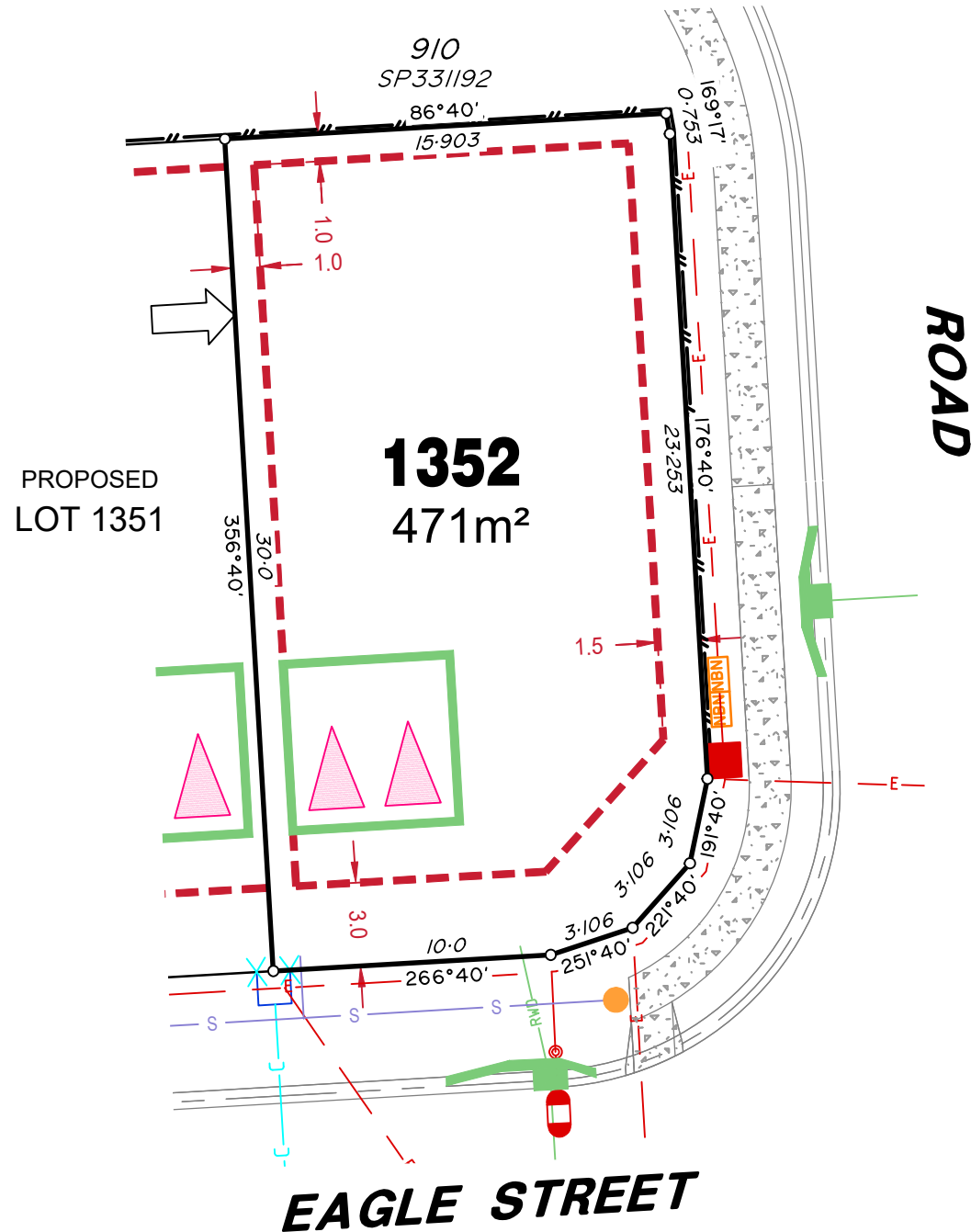

LEGEND

Rock Retaining Wall shown as:-	
Sleeper Retaining Wall shown as:-	
Landscape Retaining Wall shown as:-	
Sewer line	
Sewer Manhole	
Roofwater Drainage line and Catch Pit	
Stormwater Drainage Line	
Stormwater Manhole	
Stormwater Pit	
Water Main	
Water Conduit	
Water Service Point of Entry	
Underground Electricity, Street Light, Electricity Pillar & NBN	
Developer Fencing	
Concrete Pathway	
Zero Setback Building Line	
Landscape Street Tree	
Indicative Building Envelope	
Bin Pads	
Proposed Services Easement	
Indicative Parking Access Location	

ADDITIONAL NOTES:

Allotments used as Multiple Residential Allotments in accordance with the approved Plan of Development may have a reduced primary road setback to 3.0metres as noted on the Plan of Development Table.

Compaction of any fill material placed on this site shall be completed to level one inspection and testing services in accordance with AS3798-2007.

Location of sewer, roofwater, stormwater, water reticulation and electricity lines, manholes and pits are those shown on engineering design drawings, supplied by Colliers and may differ from the as-constructed location.

Plan of Development information Supplied by RPS Group PLC.

Copyright © Veris Australia Pty Ltd
May 2023.

Plot Date: 19 May, 2023
 Computer File Ref: 430109_S3D-SP-C.dwg