

VER.	AMENDMENT	AUTHORISED BY	DATE

FOR INTERESTS AND NOTIFICATIONS SEE SHEET 12

SURVEY CARRIED OUT UNDER REGULATION 26A
SPECIAL SURVEY AREA GUIDELINES
SEE SURVEY SHEET(S) FOR SURVEY INFORMATION
LIMITED IN DEPTH TO 12.19 METRES

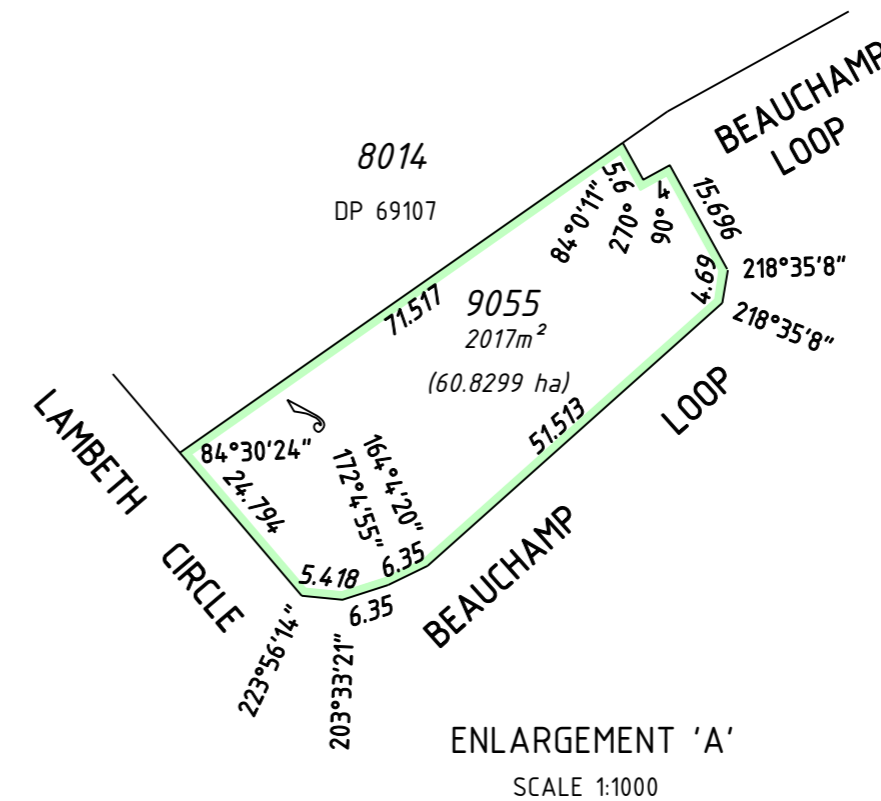
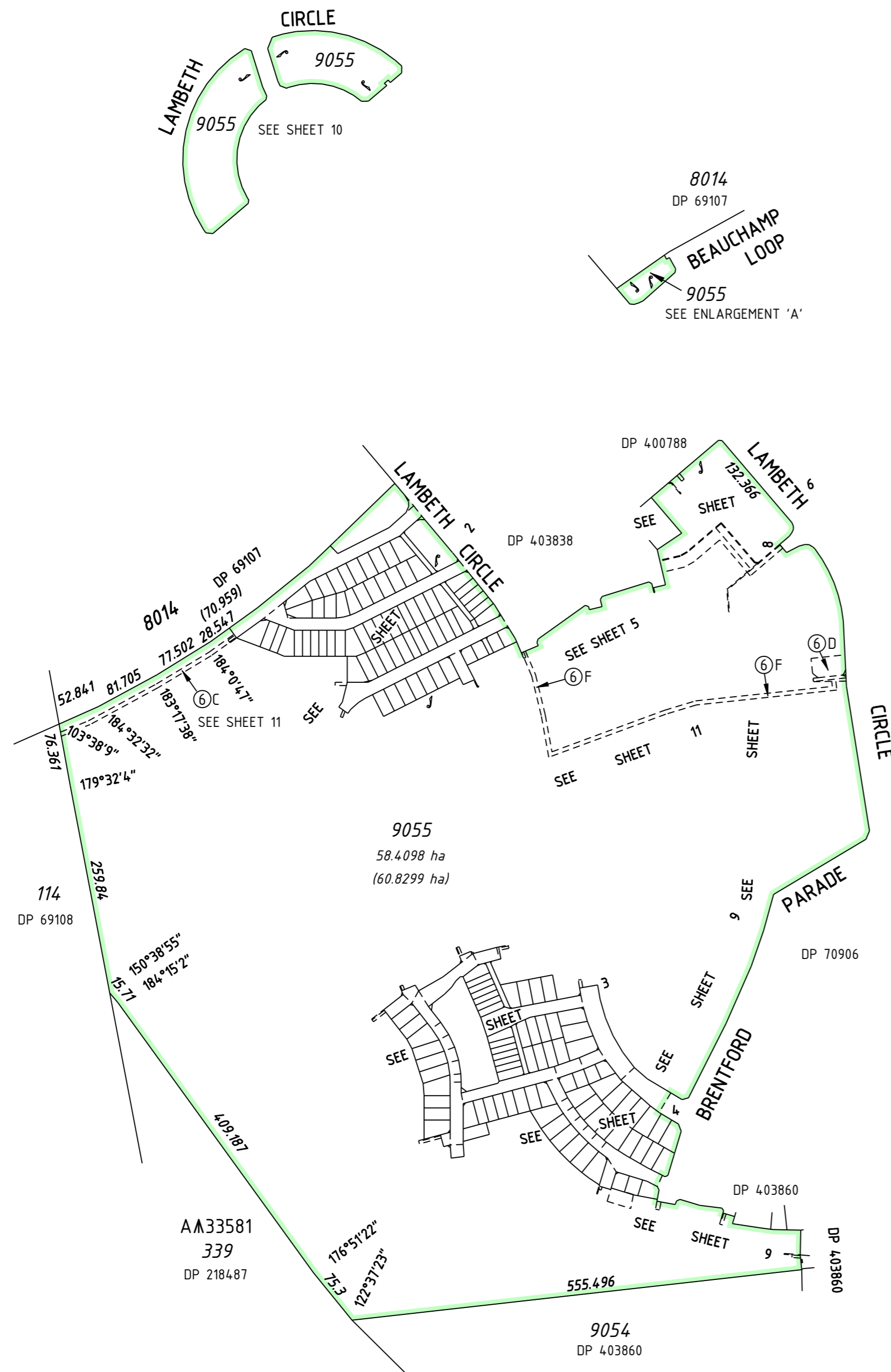

SCALE 1:5000 @ A2

HELD BY LANDGATE IN DIGITAL FORMAT ONLY

NOTE:
USE ONLY THE SURVEY SHEET(S) WHEN DETERMINING
THE TRUE FINAL POSITION AND TYPE OF ALL SURVEY
MARKS PERTAINING TO THIS PLAN.

TYPE FREEHOLD S.S.A. YES

PURPOSE SUBDIVISION

PLAN OF
LOTS 1089, 1097-1174, 1183-1219,
1221-1242, 1245-1255, 1314, 1315, 9055,
ROADS, EASEMENTS AND
RESTRICTIVE COVENANT

FORMER TENURE LOT 9053
DP 403860
C/T

LOCAL AUTHORITY CITY OF KWINANA

LOCALITY WELLARD

D.O.L. FILE

FIELD RECORD 93512, 97123, 98162
103222, 112284, 117940

SURVEYOR'S CERTIFICATE - REG 54

I, NEIL A. BARTLETT
hereby certify that this plan is accurate and is a correct
representation of the -
(a) *survey; and/or
(b) *calculations from measurements recorded in the field
records,
[* delete if inapplicable]
undertaken for the purposes of this plan and that it
complies with the relevant written law(s) in relation to
which it is lodged.

LICENSED SURVEYOR DATE

LOGGED

DATE FEE PAID ASSESS No.

I.S.C.

EXAMINED

DATE

WESTERN AUSTRALIAN PLANNING COMMISSION
FILE 149233

Delegated under S.16 P&D Act 2005 DATE

IN ORDER FOR DEALINGS

SUBJECT TO

FOR INSPECTOR OF PLANS AND SURVEYS DATE

APPROVED REG. 26A (4)

INSPECTOR OF PLANS AND SURVEYS DATE
(S. 18 Licensed Surveyors Act 1909)



DEPOSITED PLAN
403864
SHEET 1 OF 12 SHEETS
(PLUS SURVEY SHEET(S))
VERSION 1



FUGRO GEOSPATIAL
18 PROWSE STREET
WEST PERTH W.A. 6005
TEL. (08) 9282 4100
FAX. (08) 9322 1175

PLAN No. 62101125-5 (Rev.0)

FOR HEADING SEE SHEET 1
 FOR INTERESTS AND NOTIFICATIONS SEE SHEET 12

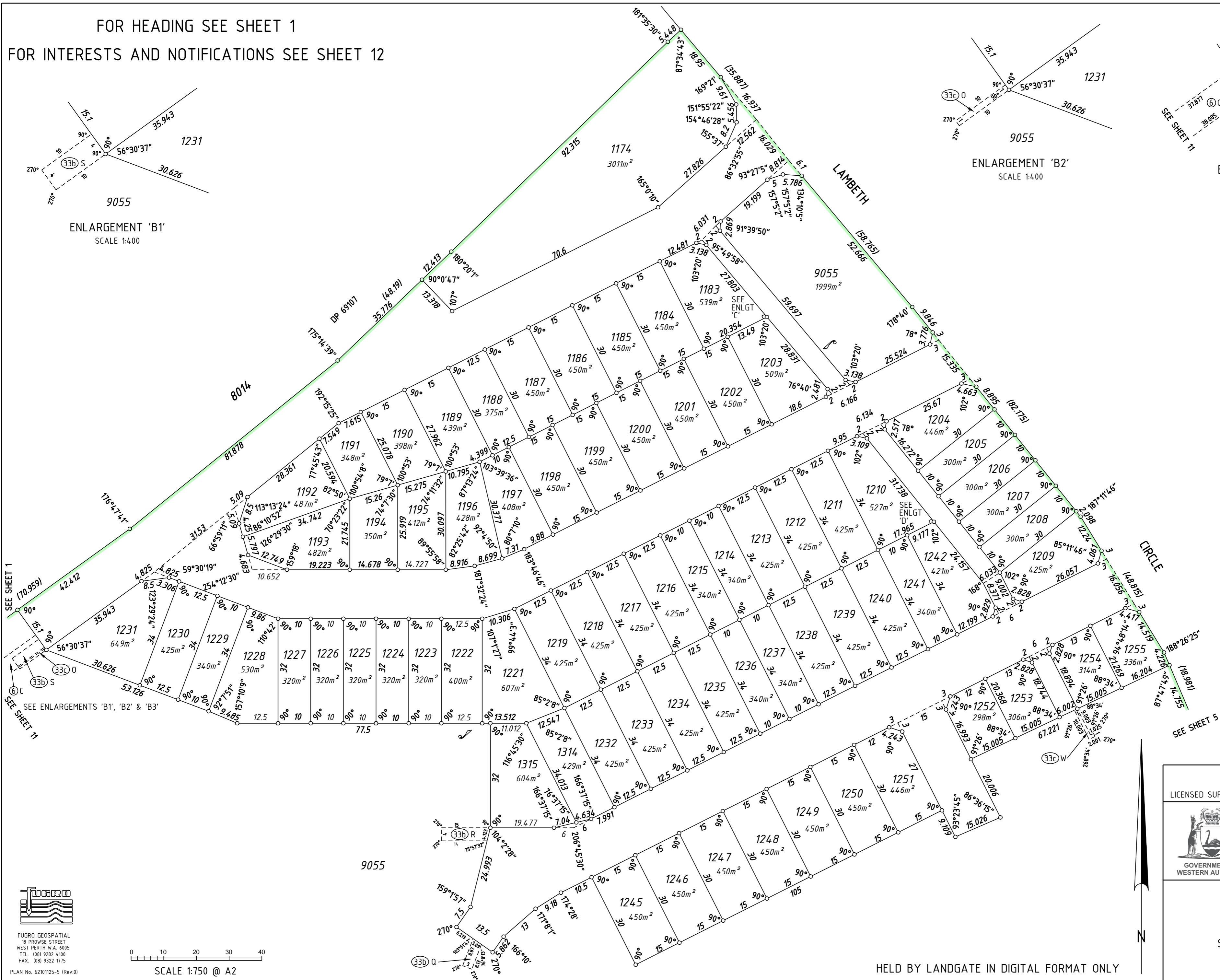
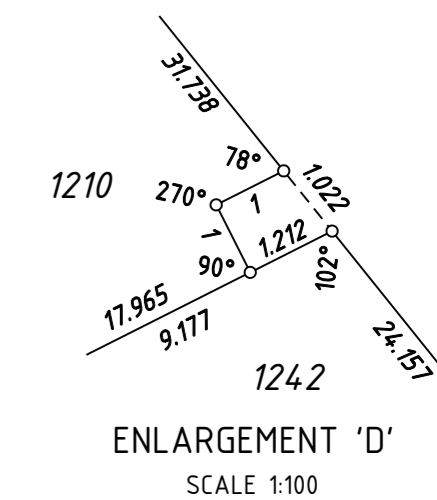
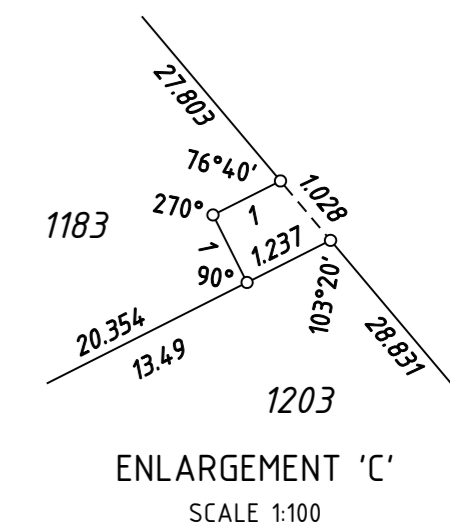
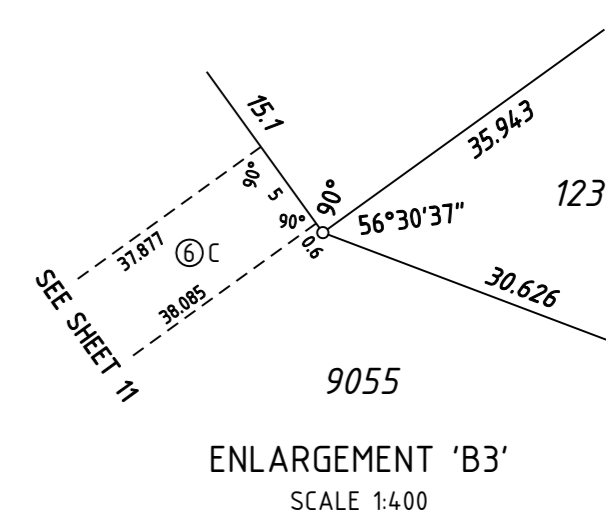
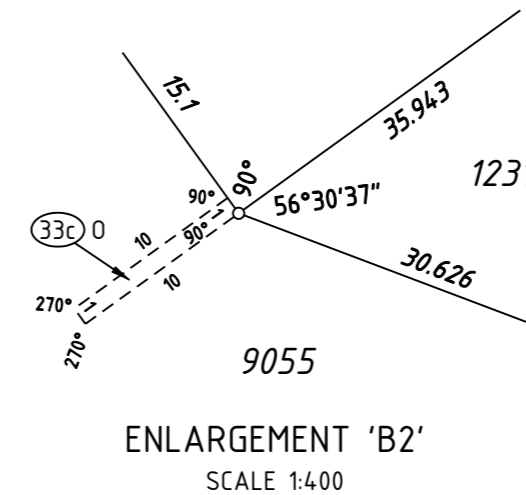
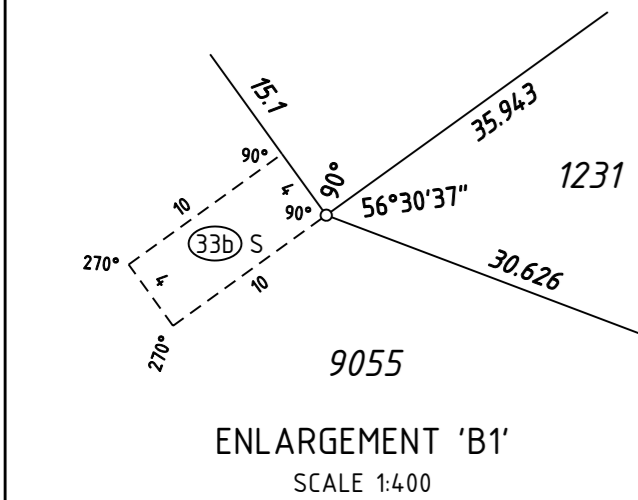

SEE SHEET 1
 SEE SHEET 11

SEE SHEET 5



FUGRO GEOSPATIAL
 18 PROWSE STREET
 WEST PERTH W.A. 6005
 TEL. (08) 9282 4100
 FAX. (08) 9322 1775

SCALE 1:750 @ A2

HELD BY LANDGATE IN DIGITAL FORMAT ONLY

LICENSED SURVEYOR DATE



GOVERNMENT OF WESTERN AUSTRALIA



DEPOSITED PLAN
403864
 SHEET 2 OF 12 SHEETS
 (PLUS SURVEY SHEET(S))
 VERSION 1

FOR HEADING SEE SHEET 1
 FOR INTERESTS AND NOTIFICATIONS SEE SHEET 12

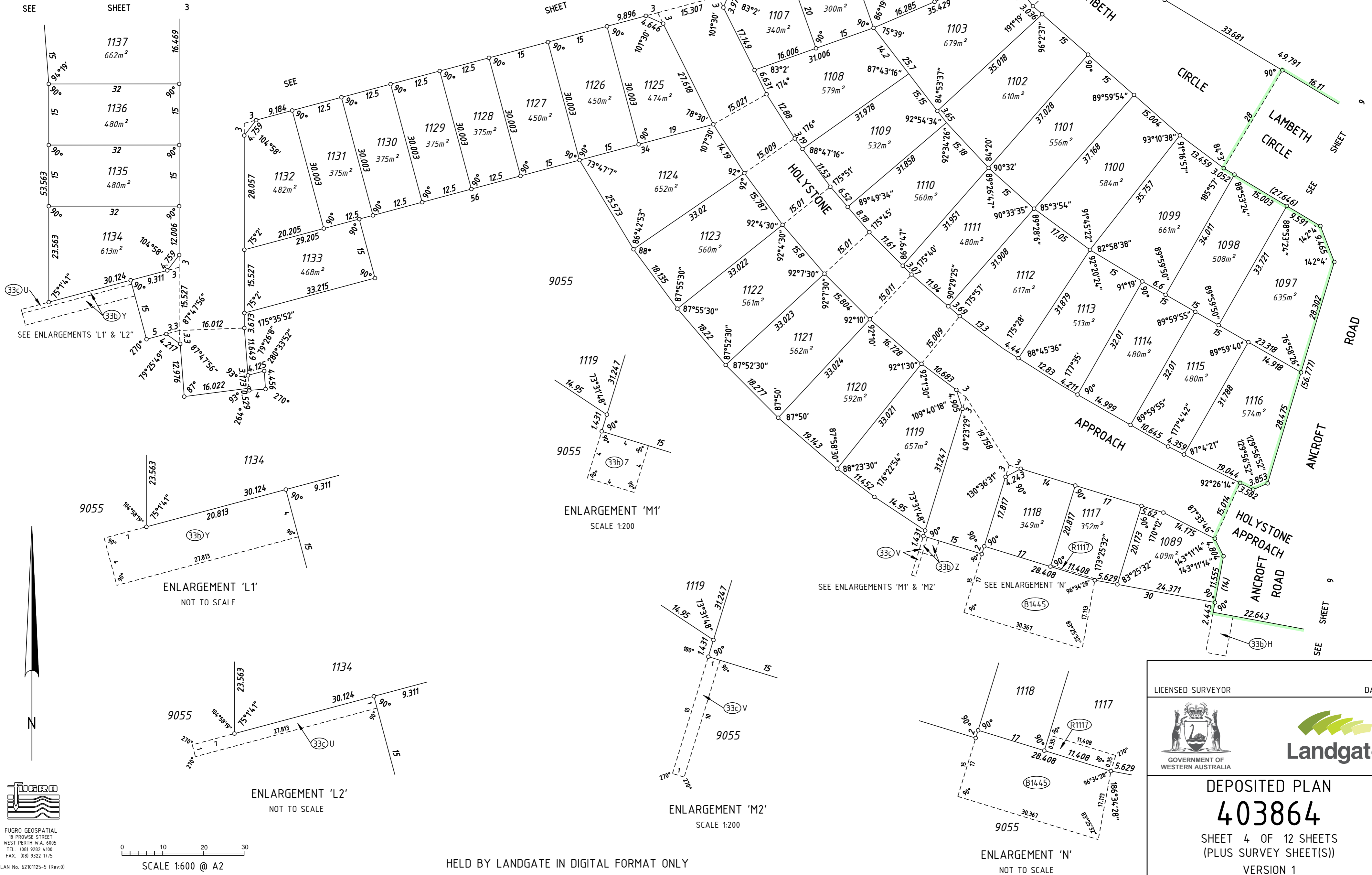

FUGRO
 FUGRO GEOSPATIAL
 18 PROWSE STREET
 WEST PERTH W.A. 6005
 TEL. (08) 9282 4100
 FAX. (08) 9322 1175
 PLAN No. 62101125-5 (Rev.0)

SCALE 1:600 @ A2

HELD BY LANDGATE IN DIGITAL FORMAT ONLY

LICENSED SURVEYOR	DATE
 GOVERNMENT OF WESTERN AUSTRALIA	
DEPOSITED PLAN 403864 SHEET 4 OF 12 SHEETS (PLUS SURVEY SHEET(S)) VERSION 1	

FOR HEADING SEE SHEET 1
FOR INTERESTS AND NOTIFICATIONS SEE SHEET 12

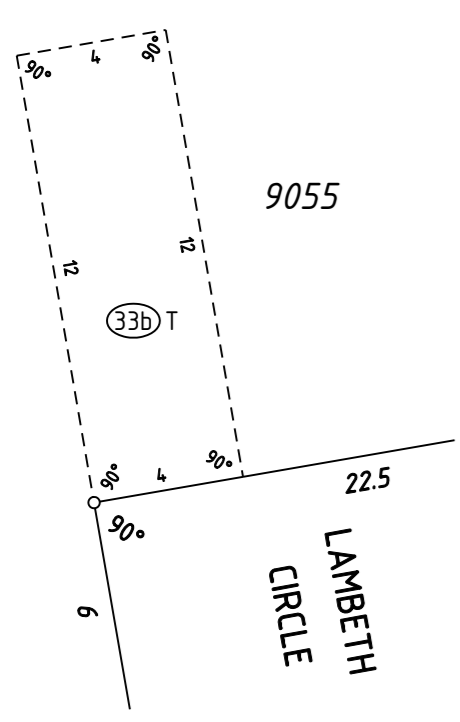

ENLARGEMENT 'E1'
SCALE 1:200

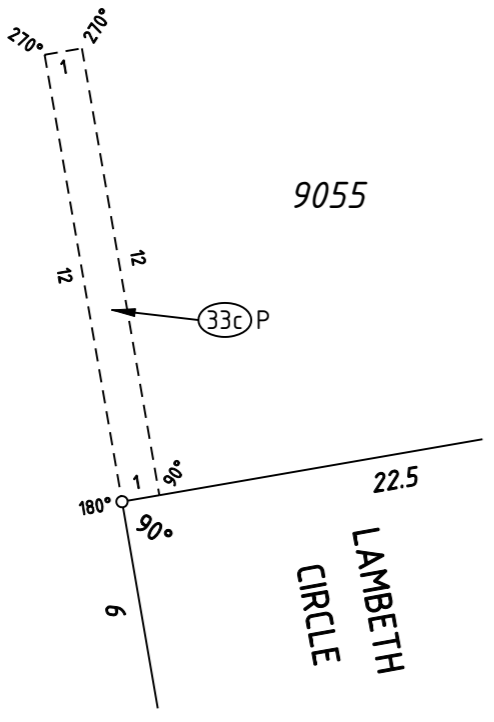

ENLARGEMENT 'E2'
SCALE 1:200

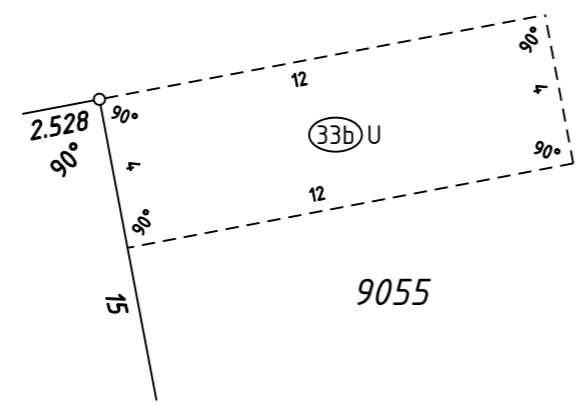

ENLARGEMENT 'F1'
SCALE 1:200

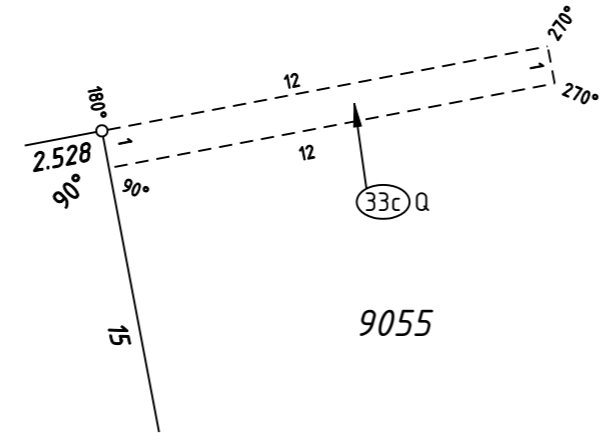

ENLARGEMENT 'F2'
SCALE 1:200

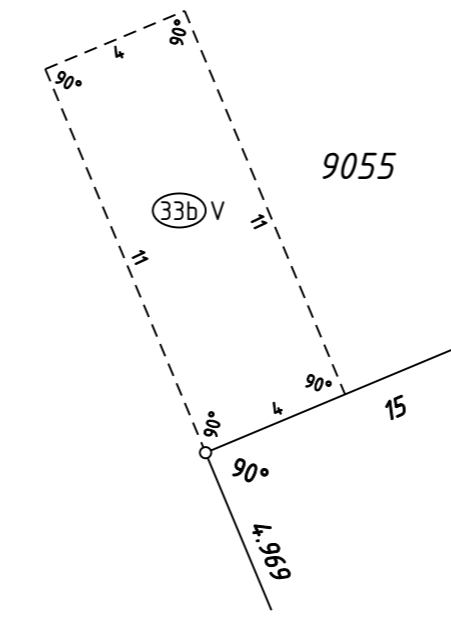

ENLARGEMENT 'G1'
SCALE 1:200

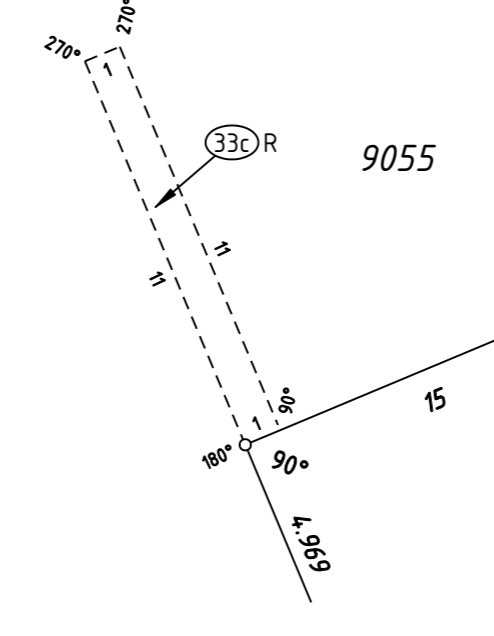

ENLARGEMENT 'G2'
SCALE 1:200

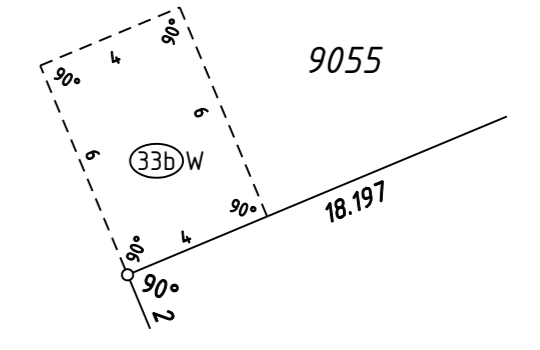

ENLARGEMENT 'H1'
SCALE 1:200

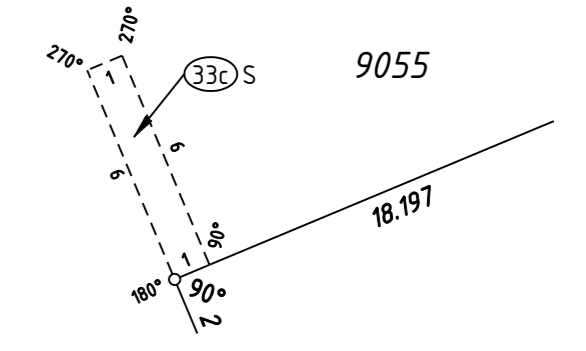

ENLARGEMENT 'H2'
SCALE 1:200

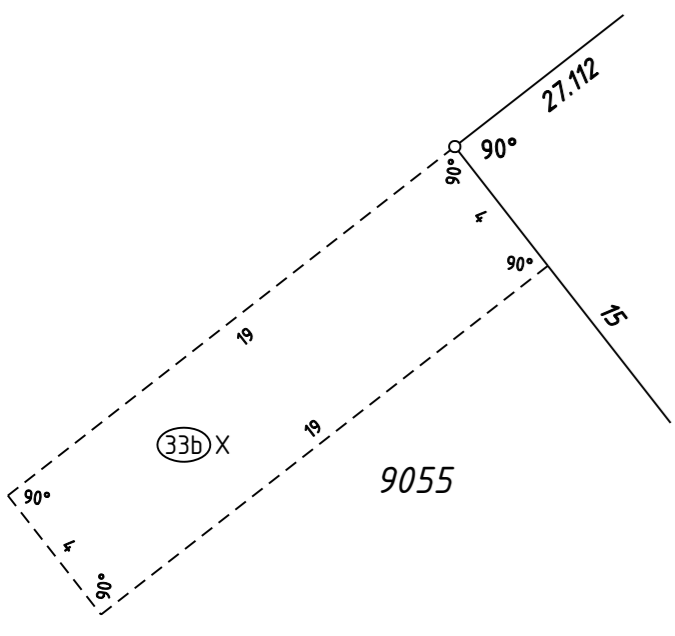

ENLARGEMENT 'I1'
NOT TO SCALE

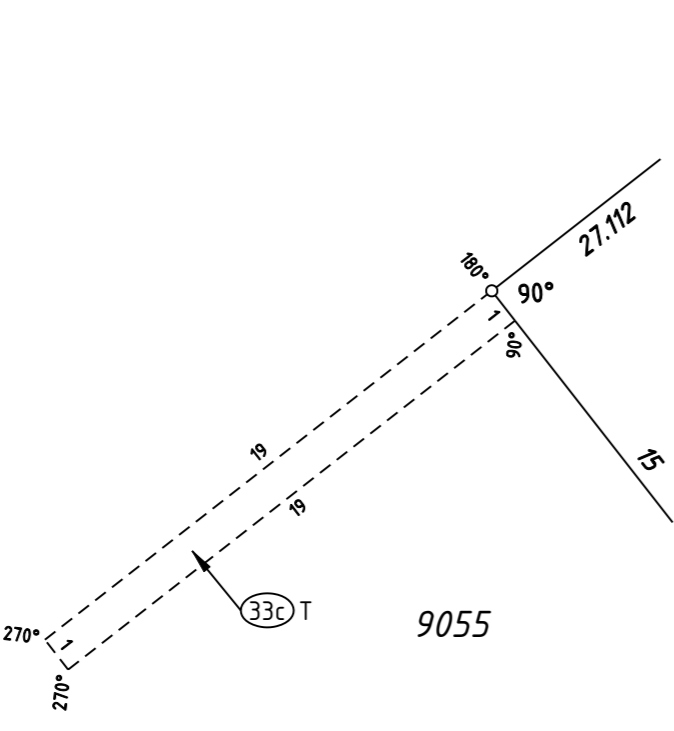

ENLARGEMENT 'I2'
NOT TO SCALE

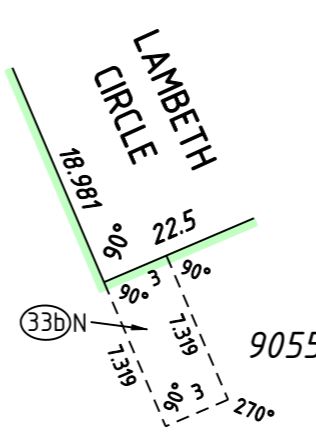
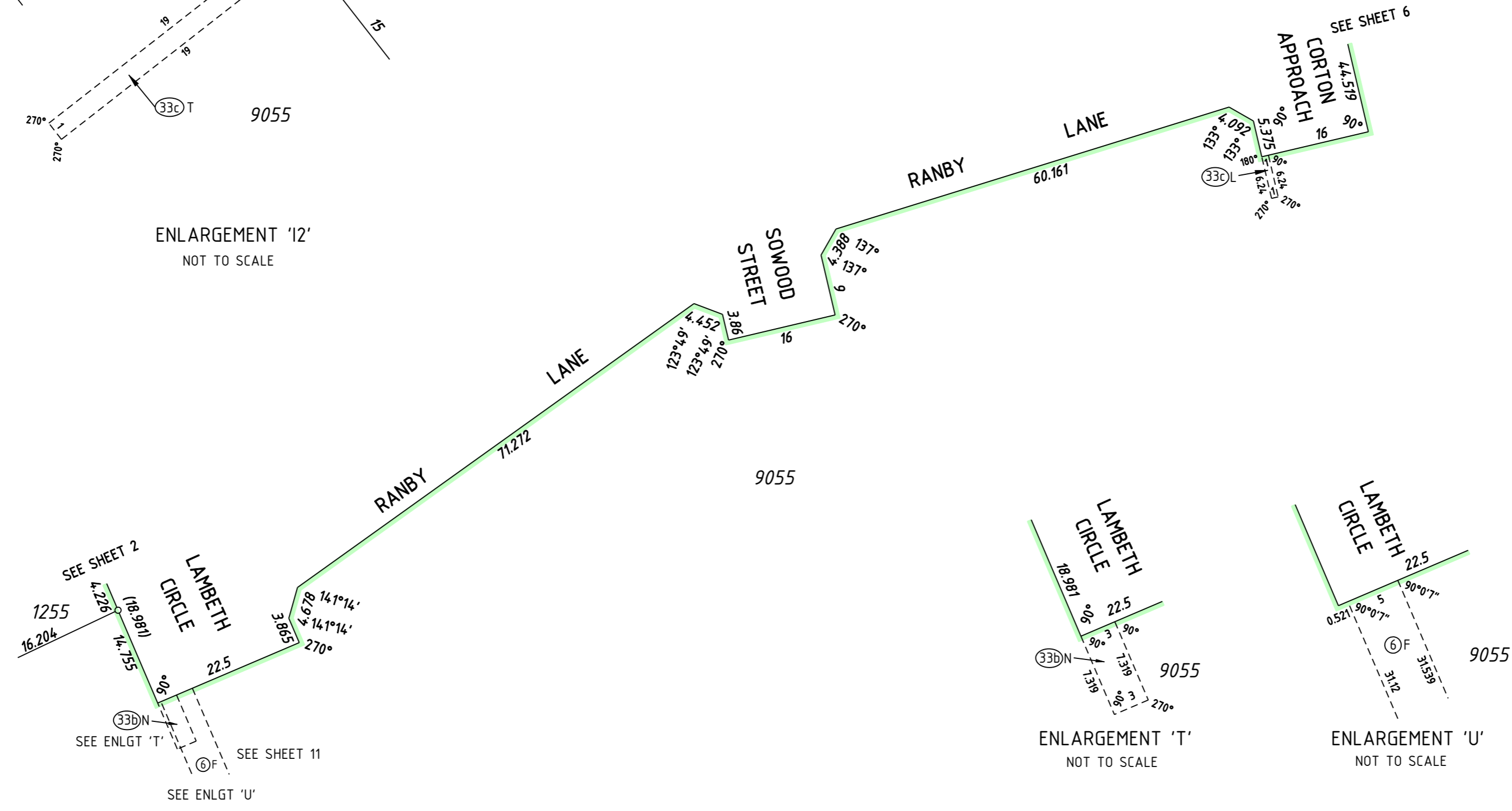

ENLARGEMENT 'T'
NOT TO SCALE

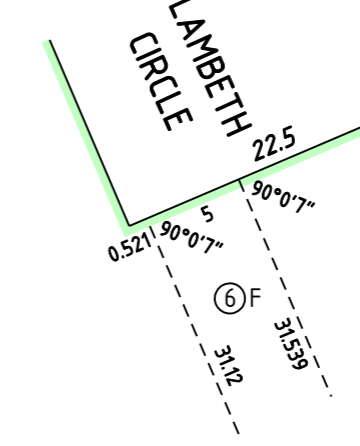

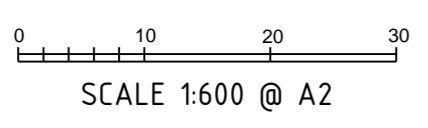

ENLARGEMENT 'U'
NOT TO SCALE



FUGRO
FUGRO GEOSPATIAL
18 PROWSE STREET
WEST PERTH W.A. 6005
TEL. (08) 9282 4100
FAX. (08) 9322 1775
PLAN No. 62101125-5 (Rev.0)

HELD BY LANDGATE IN DIGITAL FORMAT ONLY

LICENSED SURVEYOR	DATE
	
GOVERNMENT OF WESTERN AUSTRALIA	
DEPOSITED PLAN 403864 SHEET 5 OF 12 SHEETS (PLUS SURVEY SHEET(S)) VERSION 1	

FOR HEADING SEE SHEET 1
 FOR INTERESTS AND NOTIFICATIONS SEE SHEET 12

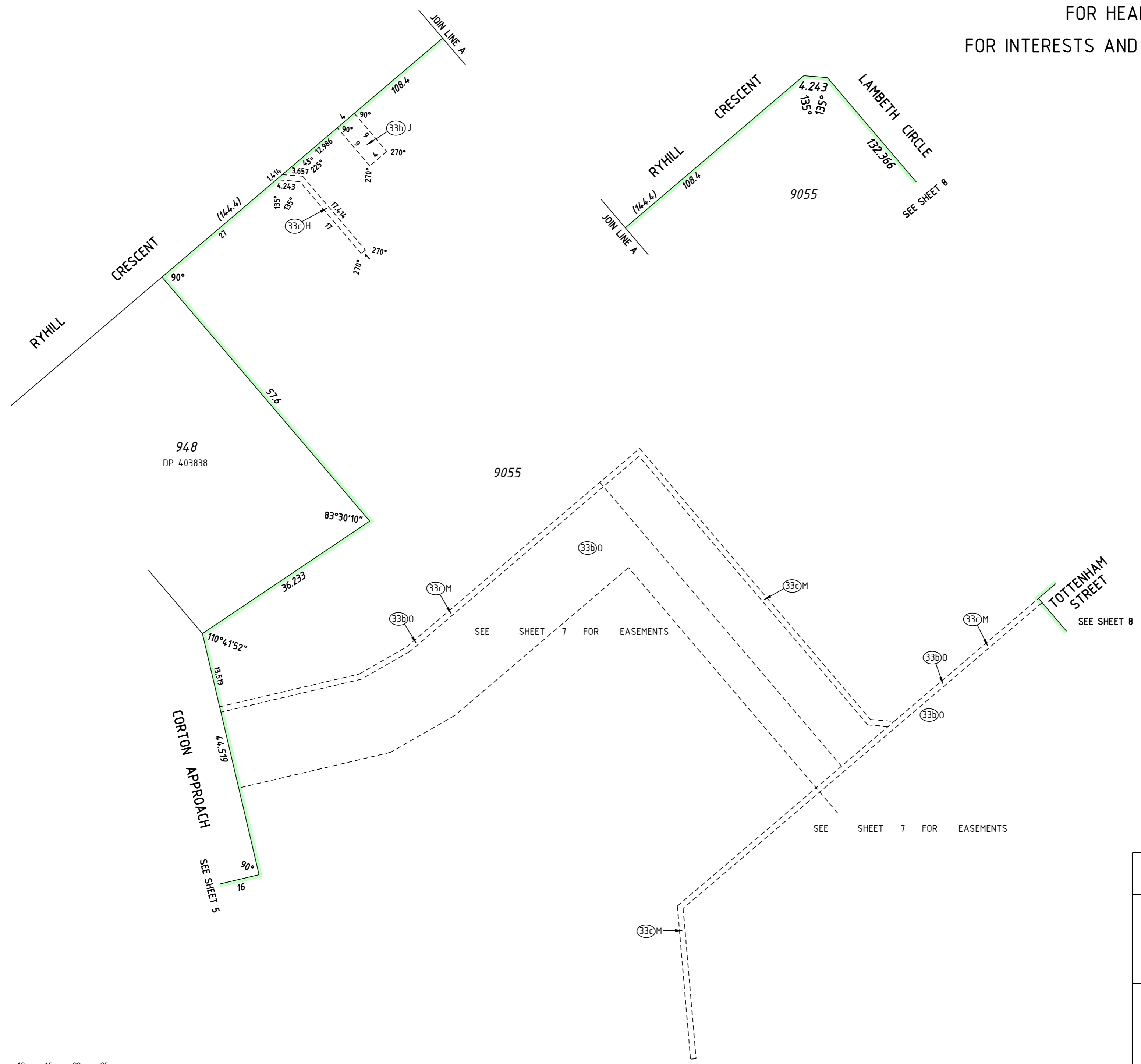

948
 DP 403838

9055

9056

SEE SHEET 7 FOR EASEMENTS

SEE SHEET 7 FOR EASEMENTS

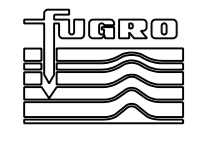
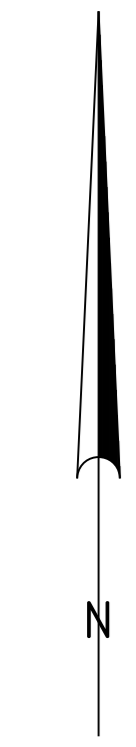

SEE SHEET 8

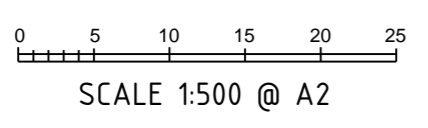

FUGRO GEOSPATIAL
 18 PROWSE STREET
 WEST PERTH W.A. 6005
 TEL. (08) 9282 4100
 FAX. (08) 9322 1775
 PLAN No. 62101125-5 (Rev.0)



HELD BY LANDGATE IN DIGITAL FORMAT ONLY

LICENSED SURVEYOR	DATE
 GOVERNMENT OF WESTERN AUSTRALIA	
DEPOSITED PLAN 403864 SHEET 6 OF 12 SHEETS (PLUS SURVEY SHEET(S)) VERSION 1	

FOR HEADING SEE SHEET 1
 FOR INTERESTS AND NOTIFICATIONS SEE SHEET 12

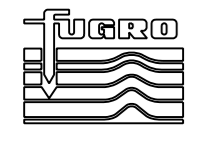
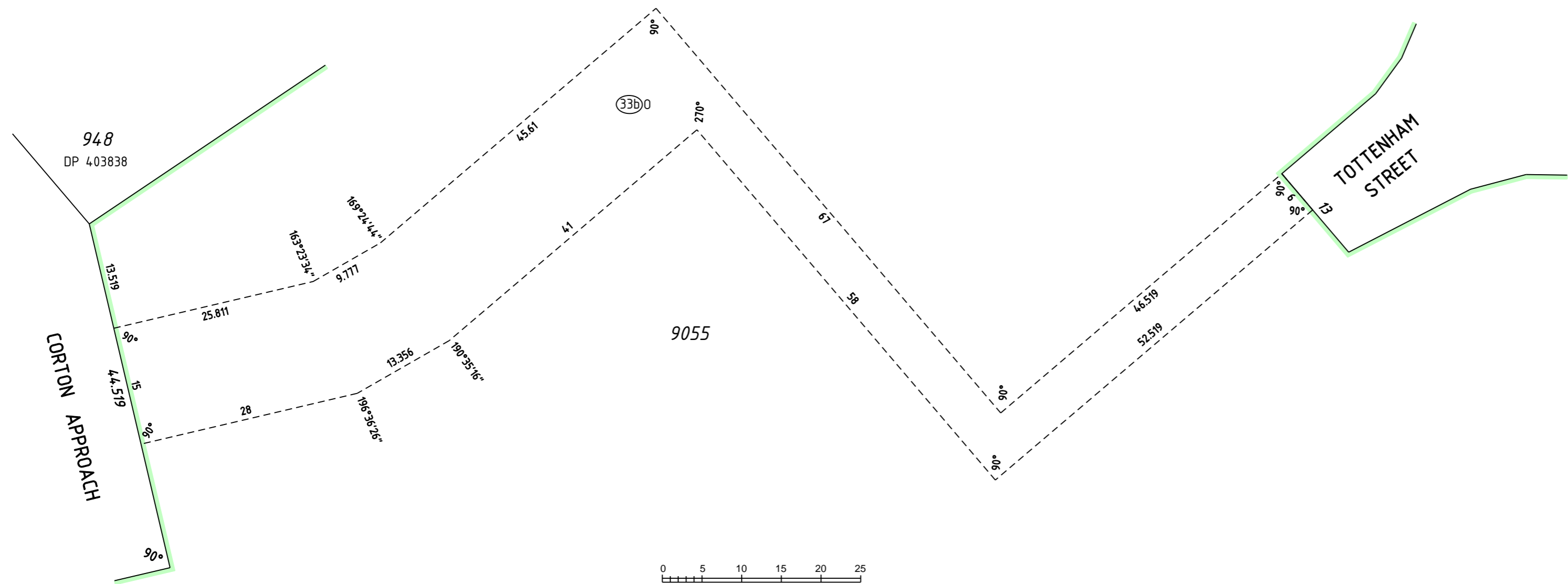
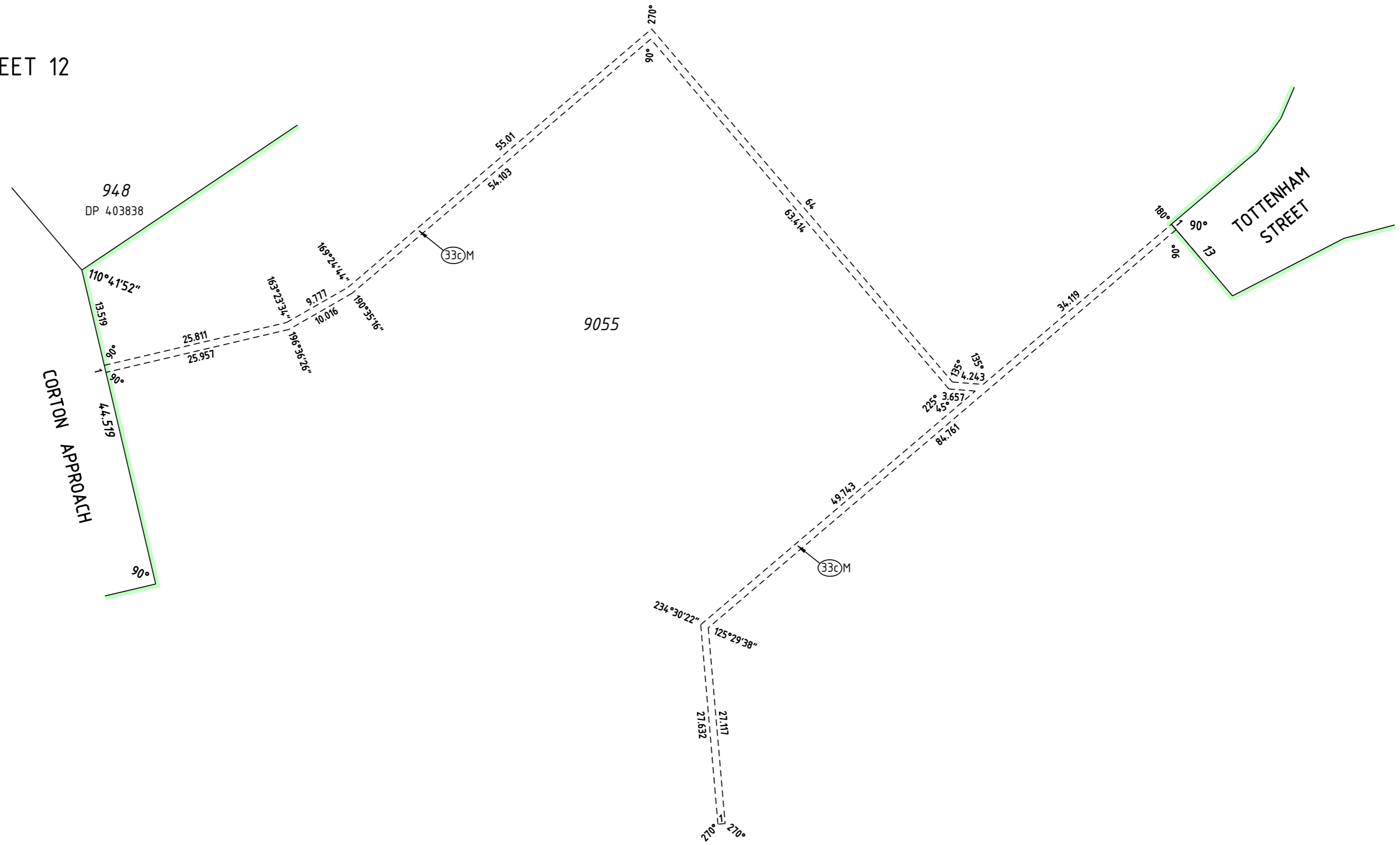

FUGRO GEOSPATIAL
 18 PROWSE STREET
 WEST PERTH W.A. 6005
 TEL. (08) 9282 4100
 FAX. (08) 9322 1775

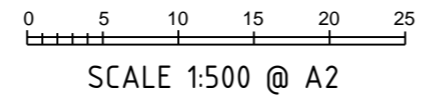

LICENSED SURVEYOR	DATE
 GOVERNMENT OF WESTERN AUSTRALIA	 Landgate
DEPOSITED PLAN <h1 style="margin: 0;">403864</h1> SHEET 7 OF 12 SHEETS (PLUS SURVEY SHEET(S)) VERSION 1	

HELD BY LANDGATE IN DIGITAL FORMAT ONLY

FOR HEADING SEE SHEET 1
 FOR INTERESTS AND NOTIFICATIONS SEE SHEET 12

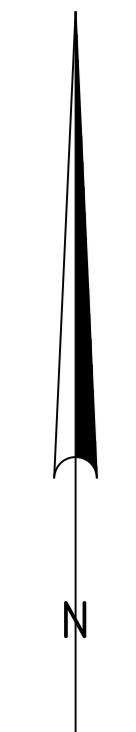
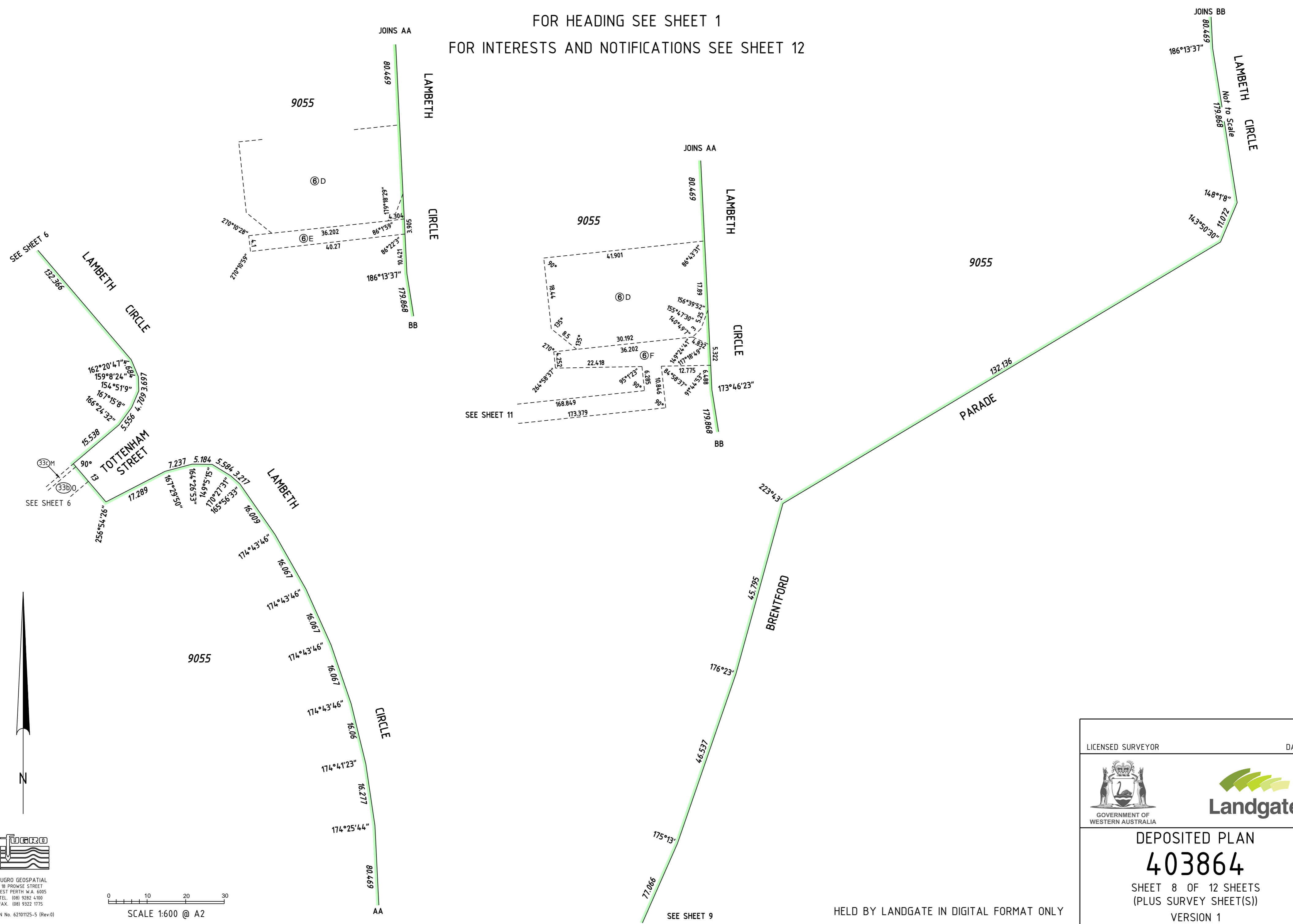

FUGRO
 FUGRO GEOSPATIAL
 18 PROWSE STREET
 WEST PERTH W.A. 6005
 TEL. (08) 9282 4100
 FAX. (08) 9322 1175
 PLAN No. 62101125-5 (Rev.0)

0 10 20 30
 SCALE 1:600 @ A2

LICENSED SURVEYOR	DATE
 GOVERNMENT OF WESTERN AUSTRALIA	
DEPOSITED PLAN 403864 SHEET 8 OF 12 SHEETS (PLUS SURVEY SHEET(S)) VERSION 1	
HELD BY LANDGATE IN DIGITAL FORMAT ONLY	

FOR HEADING SEE SHEET 1
 FOR INTERESTS AND NOTIFICATIONS SEE SHEET 12

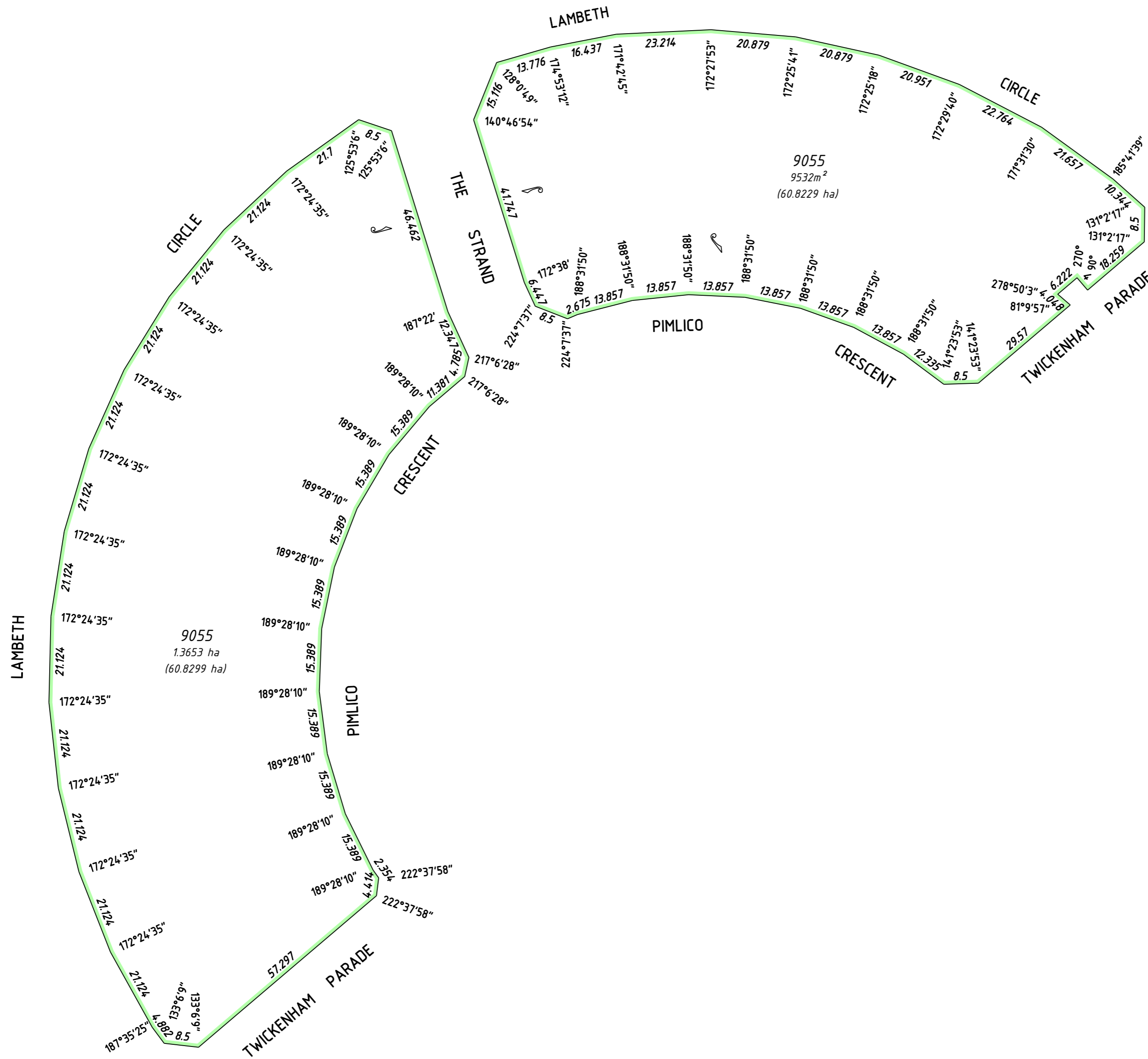

9055
 1.3653 ha
 (60.8299 ha)

9055
 9532m²
 (60.8229 ha)



FUGRO GEOSPATIAL
 18 PROWSE STREET
 WEST PERTH W.A. 6005
 TEL. (08) 9282 4100
 FAX. (08) 9322 1775

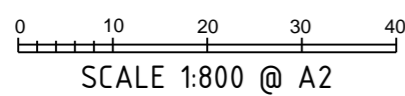

HELD BY LANDGATE IN DIGITAL FORMAT ONLY

LICENSED SURVEYOR _____ DATE _____



DEPOSITED PLAN
403864
 SHEET 10 OF 12 SHEETS
 (PLUS SURVEY SHEET(S))
 VERSION 1

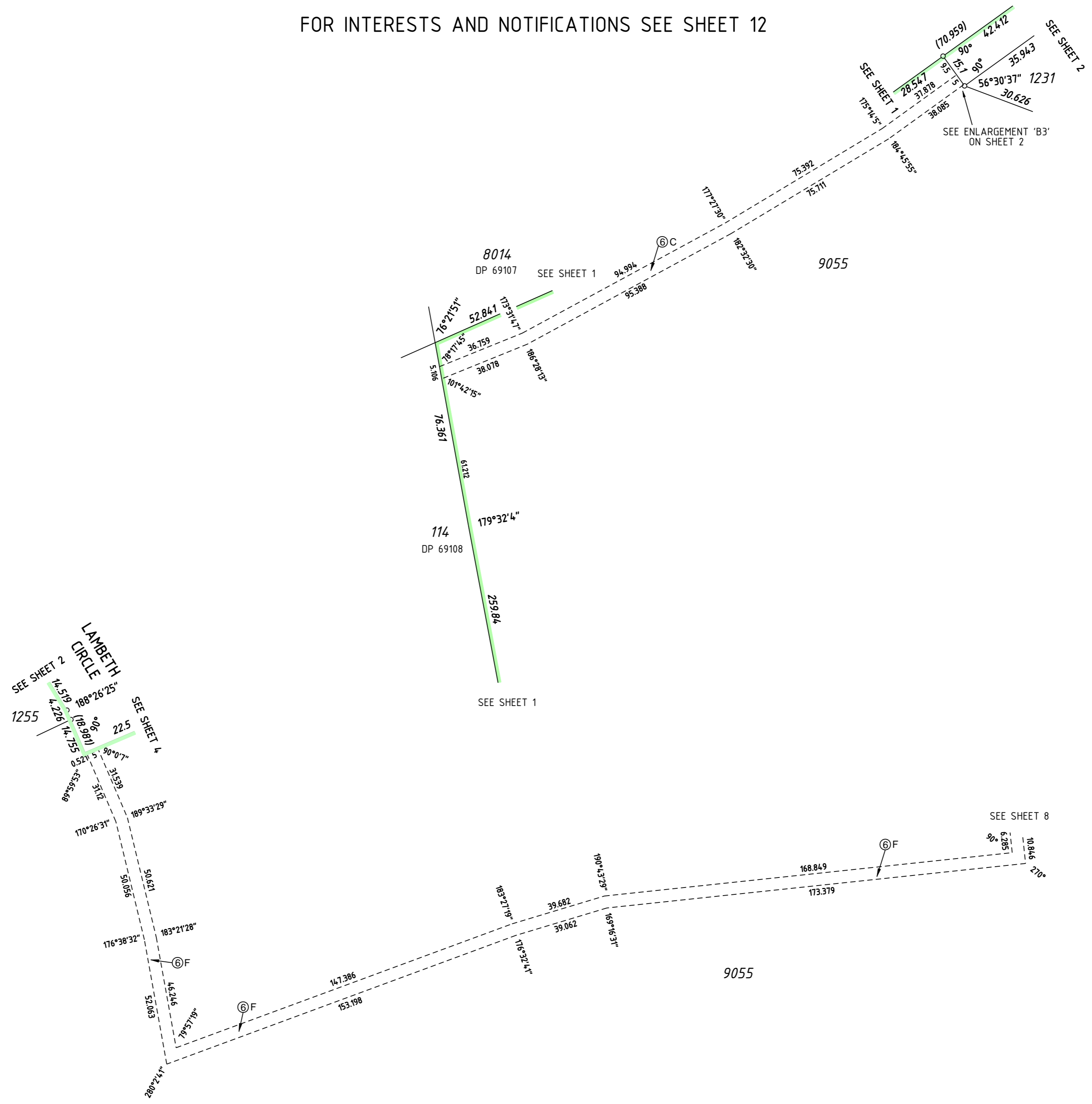

FOR HEADING SEE SHEET 1
 FOR INTERESTS AND NOTIFICATIONS SEE SHEET 12



FUGRO GEOSPATIAL
 18 PROWSE STREET
 WEST PERTH W.A. 6005
 TEL. (08) 9282 4100
 FAX. (08) 9322 1175

0 20 40 60
 SCALE 1:1250 @ A2

HELD BY LANDGATE IN DIGITAL FORMAT ONLY

LICENSED SURVEYOR	DATE
 GOVERNMENT OF WESTERN AUSTRALIA	 Landgate
DEPOSITED PLAN 403864 SHEET 11 OF 12 SHEETS (PLUS SURVEY SHEET(S)) VERSION 1	

FOR HEADING SEE SHEET 1

INTERESTS AND NOTIFICATIONS

SUBJECT	PURPOSE	STATUTORY REFERENCE	ORIGIN	LAND BURDENED	BENEFIT TO	COMMENTS
⑥C, ⑥D & ⑥F	EASEMENT (SEWERAGE)	SECTION 167 OF THE P. AND D. ACT REG. 6	DP 58621	LOT 9055	WATER CORPORATION	
⑥E	EASEMENT (WATER SUPPLY)	SECTION 167 OF THE P. AND D. ACT REG. 6	DP 58621	LOT 9055	WATER CORPORATION	
③③D G	EASEMENT (WATER SUPPLY)	SECTION 167 OF THE P. AND D. ACT REG. 33(b)	DP 75373	LOT 9055	WATER CORPORATION	
③③D H	EASEMENT (SEWERAGE & WATER SUPPLY)	SECTION 167 OF THE P. AND D. ACT REG. 33(b)	DP 75373	LOT 9055	WATER CORPORATION	
③③C C	EASEMENT (ELECTRICITY SUPPLY)	SECTION 167 OF THE P. AND D. ACT REG. 33(c)	DP 75373	LOT 9055	ELECTRICITY NETWORKS CORPORATION	
③③D J	EASEMENT (WATER SUPPLY)	SECTION 167 OF THE P. AND D. ACT REG. 33(b)	DP 400788	LOT 9055	WATER CORPORATION	
③③C H	EASEMENT (ELECTRICITY SUPPLY)	SECTION 167 OF THE P. AND D. ACT REG. 33(c)	DP 400788	LOT 9055	ELECTRICITY NETWORKS CORPORATION	
③③D N	EASEMENT (WATER SUPPLY)	SECTION 167 OF THE P. AND D. ACT REG. 33(b)	DP 403838	LOT 9055	WATER CORPORATION	
③③D O	EASEMENT (SEWERAGE & WATER SUPPLY)	SECTION 167 OF THE P. AND D. ACT REG. 33(b)	DP 403838	LOT 9055	WATER CORPORATION	
③③C L	EASEMENT (ELECTRICITY SUPPLY)	SECTION 167 OF THE P. AND D. ACT REG. 33(c)	DP 403838	LOT 9055	ELECTRICITY NETWORKS CORPORATION	
③③C M	EASEMENT (ELECTRICITY SUPPLY)	SECTION 167 OF THE P. AND D. ACT REG. 33(c)	DP 403838	LOT 9055	ELECTRICITY NETWORKS CORPORATION	
③③D P	EASEMENT (WATER SUPPLY)	SECTION 167 OF THE P. AND D. ACT REG. 33(b)	DP 403860	LOT 9055	WATER CORPORATION	
③③C N	EASEMENT (ELECTRICITY SUPPLY)	SECTION 167 OF THE P. AND D. ACT REG. 33(c)	DP 403860	LOT 9055	ELECTRICITY NETWORKS CORPORATION	
③③D Q	EASEMENT (SEWERAGE)	SECTION 167 OF THE P. AND D. ACT REG. 33(b)	THIS PLAN	LOT 9055	WATER CORPORATION	
③③D R	EASEMENT (WATER SUPPLY)	SECTION 167 OF THE P. AND D. ACT REG. 33(b)	THIS PLAN	LOT 9055	WATER CORPORATION	
③③D S	EASEMENT (WATER SUPPLY)	SECTION 167 OF THE P. AND D. ACT REG. 33(b)	THIS PLAN	LOT 9055	WATER CORPORATION	
③③D T	EASEMENT (SEWERAGE & WATER SUPPLY)	SECTION 167 OF THE P. AND D. ACT REG. 33(b)	THIS PLAN	LOT 9055	WATER CORPORATION	
③③D U	EASEMENT (WATER SUPPLY)	SECTION 167 OF THE P. AND D. ACT REG. 33(b)	THIS PLAN	LOT 9055	WATER CORPORATION	
③③D V	EASEMENT (WATER SUPPLY)	SECTION 167 OF THE P. AND D. ACT REG. 33(b)	THIS PLAN	LOT 9055	WATER CORPORATION	
③③D W	EASEMENT (WATER SUPPLY)	SECTION 167 OF THE P. AND D. ACT REG. 33(b)	THIS PLAN	LOT 9055	WATER CORPORATION	
③③D X	EASEMENT (WATER SUPPLY)	SECTION 167 OF THE P. AND D. ACT REG. 33(b)	THIS PLAN	LOT 9055	WATER CORPORATION	
③③D Y	EASEMENT (WATER SUPPLY)	SECTION 167 OF THE P. AND D. ACT REG. 33(b)	THIS PLAN	LOT 9055	WATER CORPORATION	
③③D Z	EASEMENT (WATER SUPPLY)	SECTION 167 OF THE P. AND D. ACT REG. 33(b)	THIS PLAN	LOT 9055	WATER CORPORATION	
③③C O	EASEMENT (ELECTRICITY SUPPLY)	SECTION 167 OF THE P. AND D. ACT REG. 33(c)	THIS PLAN	LOT 9055	ELECTRICITY NETWORKS CORPORATION	
③③C P	EASEMENT (ELECTRICITY SUPPLY)	SECTION 167 OF THE P. AND D. ACT REG. 33(c)	THIS PLAN	LOT 9055	ELECTRICITY NETWORKS CORPORATION	
③③C Q	EASEMENT (ELECTRICITY SUPPLY)	SECTION 167 OF THE P. AND D. ACT REG. 33(c)	THIS PLAN	LOT 9055	ELECTRICITY NETWORKS CORPORATION	
③③C R	EASEMENT (ELECTRICITY SUPPLY)	SECTION 167 OF THE P. AND D. ACT REG. 33(c)	THIS PLAN	LOT 9055	ELECTRICITY NETWORKS CORPORATION	
③③C S	EASEMENT (ELECTRICITY SUPPLY)	SECTION 167 OF THE P. AND D. ACT REG. 33(c)	THIS PLAN	LOT 9055	ELECTRICITY NETWORKS CORPORATION	
③③C T	EASEMENT (ELECTRICITY SUPPLY)	SECTION 167 OF THE P. AND D. ACT REG. 33(c)	THIS PLAN	LOT 9055	ELECTRICITY NETWORKS CORPORATION	
③③C U	EASEMENT (ELECTRICITY SUPPLY)	SECTION 167 OF THE P. AND D. ACT REG. 33(c)	THIS PLAN	LOT 9055	ELECTRICITY NETWORKS CORPORATION	
③③C V	EASEMENT (ELECTRICITY SUPPLY)	SECTION 167 OF THE P. AND D. ACT REG. 33(c)	THIS PLAN	LOT 9055	ELECTRICITY NETWORKS CORPORATION	
③③C W	EASEMENT (ELECTRICITY SUPPLY)	SECTION 167 OF THE P. AND D. ACT REG. 33(c)	THIS PLAN	LOT 9055	ELECTRICITY NETWORKS CORPORATION	
R117	EASEMENT	SECTION 136C OF THE T.L.A.	THIS PLAN AND DOC	LOT 1117	LOT 9055 (B1445)	
	RESTRICTIVE COVENANT	SECTION 136D OF THE T.L.A.	THIS PLAN AND DOC	ALL LOTS EXCEPT LOTS 1144, 1174 & 9055	ALL LOTS EXCEPT LOTS 1144, 1174 & 9055	
LOT 1144	RESERVE FOR RECREATION	VESTS IN THE CROWN UNDER SECTION 152 OF THE P & D ACT	THIS PLAN			



FUGRO GEOSPATIAL
18 PROWSE STREET
WEST PERTH W.A. 6005
TEL. (08) 9282 4100
FAX. (08) 9322 1775

NOT TO SCALE

HELD BY LANDGATE IN DIGITAL FORMAT ONLY

LICENSED SURVEYOR

DATE



DEPOSITED PLAN
403864
SHEET 12 OF 12 SHEETS
(PLUS SURVEY SHEET(S))
VERSION 1

THIS SURVEY SHEET WILL BE
REPLACED BY THE SURVEY DATA

SURVEY CARRIED OUT UNDER REG 26A
SPECIAL SURVEY AREA GUIDELINES

LICENSED SURVEYOR

DATE



DEPOSITED PLAN

403864

SURVEY SHEET



FUGRO GEOSPATIAL
18 PROWSE STREET
WEST PERTH W.A. 6005
TEL. (08) 9282 4100
FAX. (08) 9322 1775
PLAN No. 62101125-5 (Rev.0)

SCALE 1:1000 @ A2

HELD BY LANDGATE IN DIGITAL FORMAT ONLY