



## DESIGN GUIDELINES

LOTS 330M<sup>2</sup> OR GREATER



# GOOGONG CENTRAL

# GOOGONG CENTRAL DESIGN GUIDELINES

These Guidelines apply to detached houses to be built on lots greater than 330m<sup>2</sup> in **Googong Central**, and will form part of the contract you enter into when you purchase land at Googong.

Separate guidelines will be prepared for lots under 330m<sup>2</sup> including attached and apartment homes, and for rural estate homes on the edge of Googong.

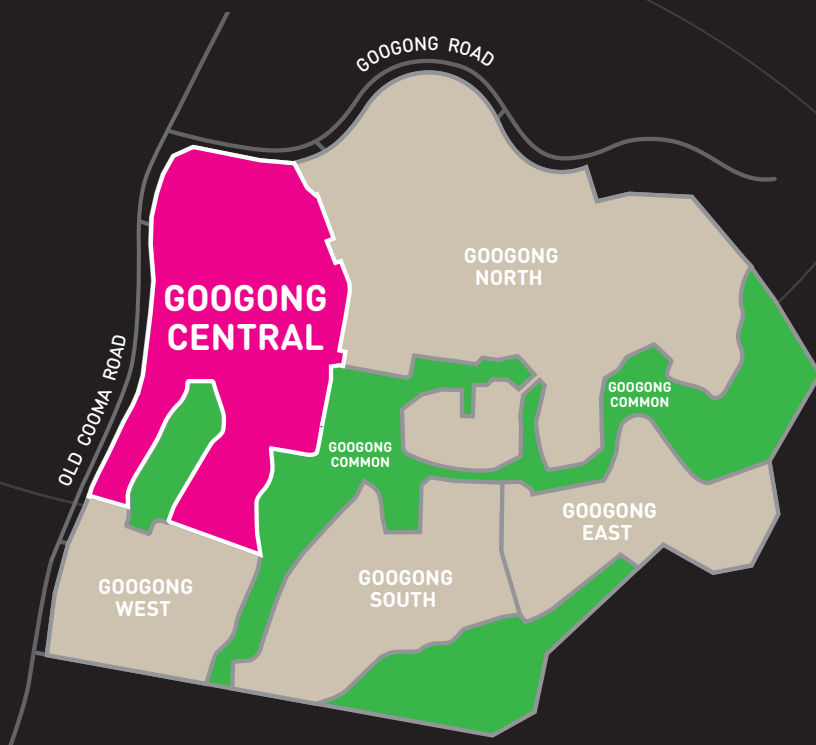

# CONTENTS

## Part One – About the Guidelines

A new beginning.....	6
What will the Guidelines do?.....	7
Googong Guild Builders and Partner Builders.....	7
Approving your home.....	8
Ensuring the Guidelines will be implemented.....	10
The ‘essence’ of Googong.....	12

## Part Two – The Guidelines

1. Front boundary.....	18
2. Side and rear boundaries.....	22
3. Front garden.....	24
4. Front verandah, porch or courtyard.....	26
5. Planning your home.....	28
6. Garages and driveways.....	34
7. Building and roof form.....	36
8. Openings and articulation.....	38
9. Materials and colours.....	40
10. Building on sloping lots.....	42
11. External elements.....	44

## Part Three – Sustainable Living

Sustainable Design Requirements.....	48
Googong Water and Energy Targets.....	49
Using BASIX.....	50
Water Management Design Requirements.....	51
Googong Home Plumbing –Schematic.....	52
Meeting BASIX Water Targets.....	53
Meeting BASIX Energy Targets.....	57

## Part Four – The Googong Palette

Front Gardens.....	62
Colour and Materials.....	78

## Appendices

Appendix 1 – Compliance Checklist.....	94
Appendix 2 – Guild Builders and Partner Builders.....	99

# GOOGONG CENTRAL DESIGN GUIDELINES





# PART ONE

ABOUT THE GUIDELINES

# A NEW BEGINNING

When you buy land at Googong, you'll be part of something unique. Googong is like no other community in the Canberra region, because it will be a self-contained township.

The township is being developed by Googong Township Pty Ltd, a joint venture between Peet and Mirvac, and will be what is called a 'masterplanned' community. This means there are general principles applied to its design, rather than letting it grow in an unplanned way.

The masterplan identifies the general location and size of the key elements of the neighbourhoods, open space, town centre, neighbourhood centres, schools and community facilities that will cater for over 15,000 people who will live, work and play at Googong.

A 'Landscaping and Open Space Strategy' will ensure Googong is a green and pleasant place to live, with almost one quarter of the site dedicated to open space and natural environment.

Googong aims to create high quality buildings, streets and landscapes, and to provide a wide choice of housing at different prices, so people can live in Googong at all stages of their lives. Because the forms of the buildings define the streets and public spaces within the town, a careful approach to design will help to create streets that people will want to walk and cycle in, not just drive through.

The Guidelines have therefore been prepared to work within the framework of the masterplan and the Landscaping and Open Space Strategy. The Guidelines consider how houses will relate to one another within a street, a neighbourhood and the developing township. While the community will evolve and change over time, the guidelines set down at the planning stage will help ensure that Googong will provide a strong sense of community and a sustainable way of life.



Googong is a new township nestled within a unique landscape where innovation, a sustainable way of living and true sense of belonging will be created.

# WHAT WILL THE GUIDELINES DO?

The Googong Design Guidelines spell out how houses can be part of an attractive street and a great town. There are twelve elements to the Guidelines, which together define the character or 'essence' of Googong.

The Guidelines will:

- help you build in a way that suits the climate and topography of Googong;
- help you get the best out of your site;
- ensure that your home is in keeping with the character and masterplan of Googong;
- guide the way your front boundary, front garden and house frontage is designed;
- help you design and build with sustainability in mind;
- give you flexibility in the way your home is designed; and
- outline the process to get your home approved.

Most importantly, **the Googong Design Guidelines will help to protect the investment in your home for years to come, by maintaining the quality of homes in your street and throughout the township.** It is worth remembering that the value of your home is just as dependent on the character of the locality as on its design and internal specifications.

## Googong Guild Builders and Partner Builders

A number of builders have been selected as Googong Guild Builders and Partner Builders. They are listed in Appendix 2 of this document, and have developed a variety of home designs which are consistent with these Design Guidelines and the overall Googong vision. The designs suit different lot sizes, solar orientation and housing preferences. These builders have a commitment to quality, innovation and value, to give you peace of mind. Their designs have been pre-approved by the Googong Design Co-ordinator. Guild Builders are open five days a week in the Display Village, and Partner Builders at weekends as a minimum.

You are not obliged to use a builder from the Guild or Partner Builders. However, if you choose another builder they will have to work within the Googong Design Guidelines and with relevant planning controls, then submit your house design for approval by the Googong Design Co-ordinator.



# APPROVING YOUR HOME

These Guidelines have been prepared to help you match the quality and character of your home and garden with the wider vision for the streets, parks and public areas.

They have a relationship with the following documents:

- Queanbeyan-Palerang Regional Council – Googong Development Control Plan 2010
- NSW Housing Code – Complying Development 2011
- Deposited Plan instruments

In broad terms the above documents deal with residential **amenity**, while these Guidelines deal with building and landscape **character**. Note that the Googong Design Guidelines may be varied from time to time by the developer (at their absolute discretion) and by the Googong Design Co-ordinator

## Queanbeyan-Palerang Regional Council Googong Development Control Plan (DCP) 2010

The DCP is prepared and administered by Queanbeyan-Palerang Regional Council and applies to housing that requires development consent (i.e. the submission and approval of a Development Application).

## NSW Housing Code (Code) Complying Development, 2011

Prepared by the NSW Department of Planning, the Code ([housingcode.planning.nsw.gov.au](http://housingcode.planning.nsw.gov.au)) specifies that if a proposed house design meets certain criteria (e.g. height, site coverage, setbacks, open space), it does not require a Development Application/Development Consent. A Complying Development Certificate (CDC) can be issued in ten days by a private certifier or by Council, providing your home meets Code requirements.

## Deposited Plan Instruments

Deposited Plan Instruments may have an impact on your lot. At Googong, these instruments are typically used to create easements to maintain access to water, sewer, gas and power and/or telecommunications infrastructure. Any lots on which housing must be constructed to be resistant to bushfire will also be identified in the instrument and on the 'Building Envelope Plan' within the Contract for Sale. The sales team can provide details for any lot.





## Lot Disclosure Plan

The Lot Disclosure Plan provided with your sales documentation shows:

- Boundary dimensions and details
- Driveway location
- Any benching
- Services and connections
- Any easements

## Steps to approval and construction

The process you will go through to get the necessary statutory approvals to build a house at Googong is the same process that applies when building a house in most new development areas in New South Wales. Most new development areas require house plans to be reviewed for compliance with design guidelines. This is the case at Googong. The steps in this process are as follows:

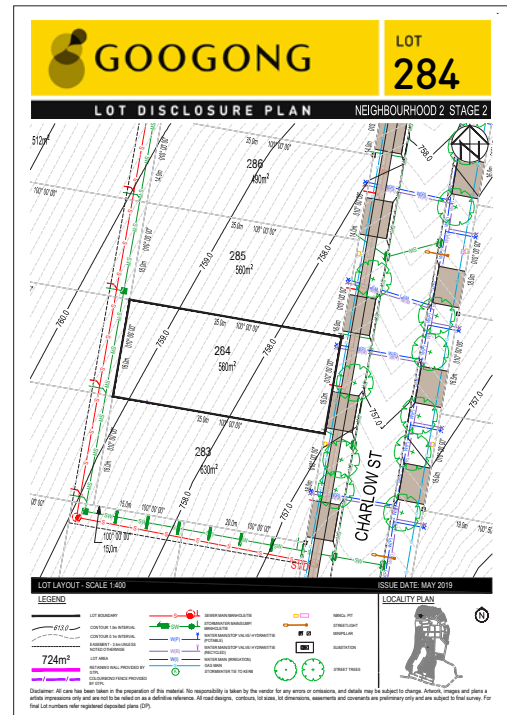

STEP 1	Review Council DCP (or complying development) requirements, and the Googong Design Guidelines requirements.
STEP 2	Analyse the site and develop design. You can contact the Googong Design Co-ordinator for feedback and advice prior to preparing full documentation, which may save you time later.
STEP 3	Prepare plans in accordance with the DCP (or Complying Development), Googong Design Guidelines, and the plans provided in your Sales Contract as well as the Lot Disclosure Plan.
STEP 4	Complete Googong Compliance Checklist.
STEP 5	Submit home and front garden plans (including driveway/paths), material and colour selections, BASIX certificates meeting targets checklists and application forms to the Googong Design Co-ordinator for approval or amendment within six months of settlement.
STEP 6	Submit Development/Complying Development Application and Construction Certificate to the relevant approval authority/certifier.
STEP 7	Complete construction according to approved plans within 24 months of settlement and provide a copy of your Occupation Certificate to the Googong Design Co-ordinator for return of your Compliance Bond as relevant.

## Ensuring the Guidelines will be implemented

To ensure compliance with the Googong Design Guidelines you will need to pay a refundable 'Compliance Bond' of \$5,000 at the time of settlement of your lot as noted in the Contract for Sale. If you have already signed with a contract with a Guild builder or partner builder that includes front garden landscape plans you will **not** be required to pay the Compliance Bond. If you choose to do the landscaping yourself having already signed with a Guild Builder or Partner Builder, a compliance bond of \$2500 will be required upon settlement.

The conditions for refund of the Compliance Bond are;

- Design Approval from the Googong Design Co-ordinator prior to Development Approval.
- No changes to the exterior of the home or front landscaping, including colours, materials, plant sizes and landscape specifications, after Googong Design Approval, unless authorised by the Googong Design Co-ordinator.
- Your home and front garden/boundary treatment have been built in accordance with the Googong Design Guidelines.
- The front verge must be clear of any building or landscape materials and grassed. Seeding is acceptable, however, evidence of growth should be visible to obtain a refund – approximately 60% coverage.
- Any damage to the surrounding public domain areas including streets, street trees, footpaths, kerbs, verge, services and adjoining land caused by the construction of your home has been rectified. These areas become council assets and must be undamaged.
- The construction and completion of your home was within the specified time periods as detailed in your contract.
- The front garden landscaping and front boundary treatment have been completed within twelve weeks of the occupation of your home.

## Claiming your Compliance Bond

- Once you have completed your front landscaping in accordance with your approved plans, you may apply for your compliance bond refund. Contact the Googong Design Co-ordinator to request the bond claim forms.
- You must have obtained a Certificate of Occupancy prior to claiming the compliance bond.

To ensure compliance with the Design Guidelines you will need to pay a refundable 'Compliance Bond' at the time of settlement...





# GOOGONG



## YOUR FRONT VERGE

The verge is the strip of land in the street at the front of your property, sometimes separated from your lot by a footpath. Googong's verges play an important role in making our town's streetscapes – and the front of your home – look attractive. To answer all your questions, we've put together this fact sheet that outlines your roles and responsibilities regarding the verge to your lot.

All verges in Googong are owned by Queanbeyan–Palerang Regional Council (QPRC), and planted by Googong Township Pty Ltd (GTPPL) with either grass, or, on a few main streets, plantings. This planting is generally done before you're required to settle on your land.

It's important to note that from the moment your land purchase at Googong has settled, you – or the contractors you engage to construct your home – are responsible for the ongoing maintenance of your verge.

Once the construction of your home is finished, under the terms of your land sales contract you are also responsible for not only clearing your verge of all building and landscape materials, but also for reinstating the verge's vegetation. If you don't, you may delay the Certificate of Occupation for your home, as well as the return of your compliance bond. During the construction process we also recommend that you protect any trees in the verge outside your home to ensure they are not damaged.

Under the QPRC Street Verge Maintenance Policy, it's your responsibility to maintain whatever planting is in place in your verge. This includes mowing, weeding and general maintenance to keep the verge orderly and attractive. Watering your verge is optional, but you'll achieve a higher level of presentation on your verge if you do water regularly.

You're not allowed to alter or replace the existing plantings without the permission of QPRC. This policy is common practice in the ACT and in most local government jurisdictions in NSW.

### Can I apply for a variation to the standard verge planting?

If you'd like to make changes to your verge, you'll need to submit a Development Application (DA) to QPRC. The best time to apply for a variation is when you submit the DA for your home. You can include a landscape plan with your DA that details your planned landscape finishes, including how you intend to finish the verge and the reason for it.

### NEED ASSISTANCE?

If you have any further questions about your front verge or a variation to it, please contact QPRC on 1300 735 025 or visit their website, [www.qprc.nsw.gov.au](http://www.qprc.nsw.gov.au).



# THE 'ESSENCE' OF GOOGONG

Googong aims to establish its own character – for homes, their front gardens and in the way homes relate to the street. We call this the 'essence' of Googong. It is derived from Googong's setting, climate and good design principles.

This 'essence' is not an architectural style, which comes and goes as fashion changes. Rather, a series of elements are combined to achieve an overall character but the guidelines allow for variety in expression, so all houses and gardens do not look the same.



There are twelve elements, which are explained in more detail in Part Two – The Guidelines. Your builder, designer and/or architect will need to work within these guidelines to achieve an approved house design. The table below summarises the key building and landscape **elements** (what), the design **intent** behind the guidelines (why), and the way this is achieved through design **requirements** (how).



## 1. FRONT BOUNDARY

### Intent

Defined boundary to distinguish the lot from the street

### Requirements

- Low stone wall or edge strip
- Fence to 1.2m or hedge
- Entry pier

## 2. SIDE BOUNDARY (CORNER LOTS)

### Intent

Attractive side boundary to corner lots which reduces fence impacts and creates appropriate privacy to rear courtyard

### Requirements

- Front boundary to 50% side depth
- Side boundary fence to 1.5m high
- Garage to rear of side street

## 3. FRONT GARDEN

### Intent

Consistent quality landscape and a layered transition between house and street

### Requirements

- Based on palette of designs
- Front garden landscape subject to refundable bond on completion
- 30% min garden beds
- 2 x 45 litre minimum trees

## 4. FRONT VERANDAH, PORCH OR COURTYARD

### Intent

Useable open space in front of house that encourages interaction with the street

### Requirements

- Useable depth 1.8m – 2.4m, and minimum 3.5m width
- Linked to house with door(s)
- Shaded, at least in part
- Preferably raised from street level

## 5. HOUSE PLANNING

### Intent

Houses that respond to the lot, indoor outdoor living, and present a friendly face to the street

### Requirements

- Generally two rooms to street
- Indoor/outdoor living to sunny areas
- Cross ventilated

## 6. GARAGE AND DRIVEWAY

### Intent

Garages and driveways designed to integrate with house, and not visually dominate the street

### Requirements

- Visually recessed from street
- Garage on side street for corners
- Driveways toned to reduce impact



## 7. BUILDING AND ROOF FORM

### Intent

Well proportioned, building and roof forms

### Requirements

- Ground floor height 2.55m-2.7m
- Building height overall max 8.5m
- Generally pitched roof form, with minimum 450mm eaves
- Skillions permitted with specific controls applying
- Corners to address both streets

## 8. OPENINGS AND ARTICULATION

### Intent

House frontages that have well proportioned openings and break down massing with appropriate external detail

### Requirements

- Vertically proportioned openings/frames
- Defined light and shade elements
- Clear street entry

## 9. MATERIALS AND COLOURS

### Intent

A palette that breaks down the mass of the house, anchors the building to the context, and expresses features and details

### Requirements

- Mix of materials to each house
- Palette of wall, roof and feature materials/colours
- At least two materials or finishes to distinguish façade



## 10. SLOPING LOTS

### Intent

Respond to the site levels with designs that reduce need for earthworks and retaining walls, and change levels as appropriate

### Requirements

- Maximum retaining wall height 1.0m

## 11. EXTERNAL ELEMENTS

### Intent

Minimise visual impacts from external elements through defining locations and key design parameters

### Requirements

- Parameters for air conditioning solar panels, antennae, plumbing, pools, sheds, water tanks, meters

## 12. SUSTAINABLE LIVING

### Intent

Create a holistic township which promotes healthy living and where energy and water efficiency are part of a sustainable system

### Requirements

- BASIX energy (40% minim saving) and water (50% min saving) certificates required

# GOOGONG CENTRAL DESIGN GUIDELINES







# PART TWO

## THE GUIDELINES

# 1. FRONT BOUNDARY

## DESIGN INTENT

Define the boundary with a vertical element, and distinguish the front garden from the street to encourage use of the front verandah, and therefore interaction between the house and the street.

## EXPRESSION

- Low stone wall or edge strip required along the boundary. Edge strip should be flush and have a smooth finish,
- Open fence or hedge required to define the public private interface,
- Entry Pier required, and
- Terraced retaining walls to be used for level changes, with planting used to break down the mass of retaining walls.



## FRONT BOUNDARY TREATMENT OPTIONS

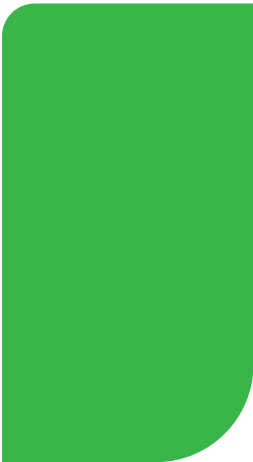

### Wall, retaining wall or edge strip

- m** Minimum requirement is that an edge strip or low wall is to be located at the front boundary.
  - If an edge strip is constructed, it must be a brick on edge or a paving stone in earth/grey colour range.
  - Edge strip should be flush or smooth, rocks not permitted.
  - If a wall is to be constructed it must be in stone, stone finish blockwork or rendered masonry in earth/grey colour range.
  - Height of wall maximum 600mm above ground level.
  - Maximum height of wall in combination with retaining wall 1.0m.
  - Retaining walls visible from the street to be constructed in stone, stone finish blockwork or rendered masonry in earth/grey colour range.
  - Timber retaining walls are not permitted where visible from the street or open space.

### Fences and hedges

- m** Minimum requirement is that a hedge or fence is to define the front boundary.
- m** Front boundary treatment to return along the side boundary to 1m minimum behind the building line or adjacent/proposed building line (whichever is the greater setback from the front boundary).
- m** Side boundary treatment (between front boundary and house frontage) to be created on non-garage side of lot – other side to be completed by neighbour.
  - Front fence maximum height 1.2m – may be designed in conjunction with low wall/piers/pillars.
  - Fencing must be in open form timber or metal pickets, slats, metal palisade or similar. No pool fencing, mesh fencing or unpainted timber palings.
  - Hedge species to be consistent with plans in Part Three ‘The Googong Palette’.
  - Hedge plants to establish a clear and consistent vertical boundary definition.
  - Hedge plant centres to be located at approximately 200mm from boundary edge strip/wall.
  - Hedge species to be planted on typical street frontages at minimum pot size 200mm and minimum spacing 500mm (centres) and must be a minimum of 300mm in height above finished ground level. For frontages to key streets and open spaces (see plan on page 21) hedge species are to be planted at minimum advanced size of 25 litres, maximum spacing of 700mm (centres).
  - Hedges to be maintained at max 1.2m high – species to be selected to avoid growing too large at maturity with associated maintenance issues.



## Entry pier

- **m** Minimum requirement is that an entry pier be constructed for each home, to contain letterbox and street number.
- Entry pier to maximum height of 1.2m.
- Entry pier/letterbox must be located at site boundary to allow access for mail delivery.
- Entry pier to be constructed in stone, stone finished blockwork or rendered masonry in mid earth to dark grey colour range or to match house colour palette.
- Other piers used to define boundary or support fences in stone, stone finish or rendered masonry to house colour palette to maximum height 1.2m.
- Other letterboxes are not generally permitted but requests will be considered on merit.



# 2. SIDE AND REAR BOUNDARIES

## DESIGN INTENT

For corner lots, define the boundary to the side (secondary) street to distinguish the lot from the street, and to create appropriate privacy for side and rear courtyard/garden.

Avoid the dominance of long fence sections to secondary street boundaries.

Present attractive fencing facing the street between houses immediately behind the building line.

Allow for standard fencing types for rear and side inter-allotment backyard fences.

## DESIGN REQUIREMENTS

**m** Represents a mandatory design requirement.

### Corner lots (boundary to secondary street)

- m** Front fence or hedge is to return along the secondary street boundary to a minimum of 50% of the lot depth, at 1.2m max height in open style, and to match front boundary treatment.
- The remainder of the side fence to a maximum of 1.5m in height and 50% maximum of the secondary street boundary length in open style.
- Where there is a garage at the rear of secondary street boundary (which is the typical situation at Googong) the side fence type is to return adjacent to the driveway to typically meet the rear of the house or the garage.
- m** Fence or hedge must be completed as part of the house construction and prior to occupation.
- Preferred materials for side fences to street frontage are:
  - painted timber with posts and top rail
  - pre-finished metal or artificial timber – vertical or horizontal palings
  - piers or piers/plinth with panel/slat infill.
- Lower quality finishes to street frontage such as unpainted timber or standard Colorbond® (e.g. Neetascreen) will not be approved



## CORNER LOT

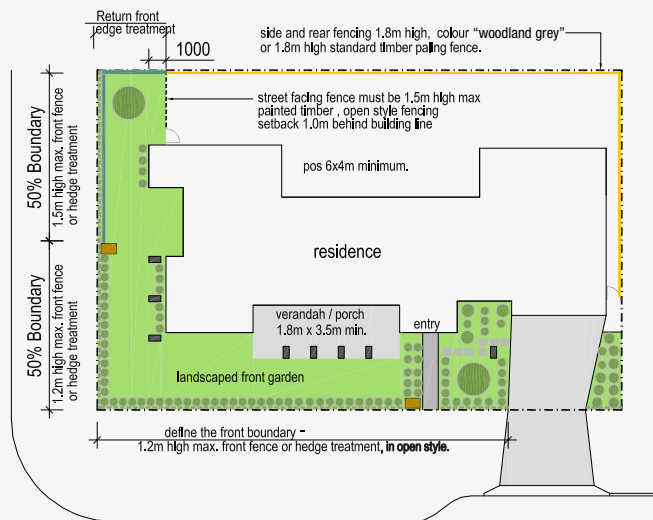

## TYPICAL LOT

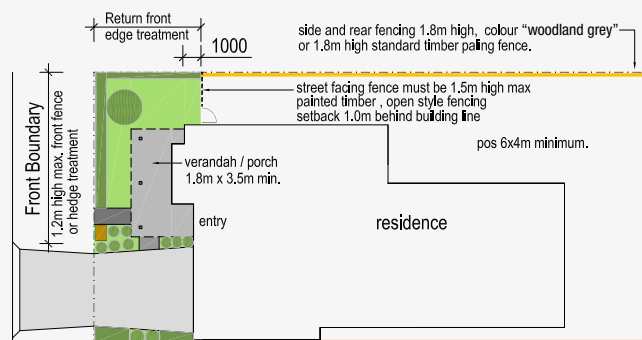

## CORNER AND TYPICAL LOT

### Street-facing fencing between house and side boundary

- Street facing fencing to be located at least 1m back from adjoining building line or adjacent (including proposed) neighbouring building, whichever is the further set back, to a max height of 1.5m
- Street facing fencing must be in open style.
- Preferred materials for these fences are as for corner lots, boundary to secondary street:

### Side and rear boundary (inter-allotment) fencing

- Side and rear inter-allotment fencing to a maximum height of 1.8m with 1m setback behind adjoining building line.
- Timber palings, Colorbond® Fences or similar can be used, but are limited in colour to 'Woodland Grey'.

# 3. FRONT GARDEN

## DESIGN INTENT

Establish front gardens that create consistent high quality presentation to the street, and respond to the street/landscape themes and wider setting of Googong.

Establish a diverse and richly textured landscape that adds to the character of Googong.

## EXPRESSION

Select from a palette of landscape concepts developed for use at Googong, to create:

- a layered planting design within the front garden and a visually interesting transition from street to house.
- front gardens that encourage use of the outdoor verandah space.
- easy maintenance front gardens that will look good and add to the experience of moving around the streets of Googong.

## DESIGN REQUIREMENTS

**m** Represents a mandatory design requirement.

- m** The front verge is to be cleared of building or landscape materials after construction. The verge must then be reinstated, i.e. top soiled, levelled and grassed. Artificial turf is not permitted in front landscaping/council verge.
- m** Front garden landscape is to be completed within 12 weeks of the occupation of your home at Googong – this is a condition of refund of the Compliance Bond (see ‘Ensuring the Guidelines will be implemented’).
- m** As a minimum (and a condition of refund of your Compliance Bond) the front garden landscape must satisfy the following requirements:
  - Define the front boundary with an edge strip or wall as detailed in ‘1. Front Boundary’.
  - Define the front boundary with a hedge or fence as detailed in ‘1. Front Boundary’.
  - Define the entry to the lot/house with a letterbox pier as detailed in ‘1. Front Boundary’.
  - On lots with a frontage of 18m or greater create a separate pathway between the street and the front porch/door (variations will be at the discretion of the Googong Design Co-ordinator).
  - At least 30% of the front garden area (not including front hedge) is to comprise planted garden beds. See the concept plans in Part Three for examples of appropriate layouts and garden beds. The balance can comprise turf, mulch, gravel, hardscape or similar.
  - Plant at least two small/medium trees to a minimum size of 45 litres and height of 1.5m (100 litres preferred) – see list of appropriate trees in Part Three.
- Examples of typical concepts that are to form a basis for front garden design (layouts, materials and plants) are included in Part Four – The Googong Palette.





# 4. FRONT VERANDAH, PORCH OR COURTYARD

## DESIGN INTENT

To create a relationship between your home and the street, homes at Googong must incorporate a verandah, porch or courtyard within the front setback. This will establish a useable area that overlooks your street, breaks down the scale of the built form, offers a differently oriented outdoor space and provides weather protection to your home.

## EXPRESSION

- Useable depth verandahs and porches that are preferably raised from the street level.
- Lower pitched roofing elements (than the main roof) that provide a shady, semi private area, and create a lightweight edge to break down the building mass.
- Consider wiring for and installation of outdoor lights and ceiling fan for useability.
- On corner sites consider 'wraparound' verandah elements.
- Courtyards can be considered where good solar aspect or views allows the establishment of a wider paved area.
- Preferably provide door(s) to the front verandah/courtyard from an adjacent room so that there is an effective and functional connection between the internal and external spaces.
- Where front courtyards are used, dwarf walls, planting, fencing, and level change should be used to define the paved area.

## DESIGN REQUIREMENTS

**m** Represents a mandatory design requirement.

- m** A front verandah, porch or courtyard is required to the street frontage of each dwelling, which is to be covered at least in part by a shade structure e.g. metal roof or timber battens of minimum 1.5m deep and minimum 3.5m wide (refer section page 27).
- m** To create a useable front area, the minimum depth of the front verandah, **porch or courtyard floor is to be 1.8m, with a depth of 2.4m preferred.** The minimum width is to be 3.5m, which can include the area in front of the entry door. For frontages of 13.5m a minimum width of 3.5m may not be possible if approved under the Housing Code. Please refer to Googong Design Co-ordinator for advice.
- m** Where the front verandah, porch or courtyard is not contiguous with the front entry door or other access door, provide door(s) from the adjacent room.
- m** Consider the scale and materials used for columns supporting verandahs & porches within the context of the overall design.. Timber or metal posts extending from within masonry piers are acceptable. Stand alone timber or metal posts are also acceptable. Masonry piers extending to soffit lines can look very heavy and may only be considered on merit.
- An 'articulation zone' of 1.5m forward of the minimum front setback line of the house allows for the establishment of verandahs, porches balconies and window hoods. The maximum width of elements within the articulation zone is 25% of the dwelling width (Housing code) and 45% of the dwelling width (DCP). For example if the front setback is 4.5m and house frontage is 16m, a front porch/verandah structure may be built to within 3m of the front boundary to a maximum width of 4m (Code) or 6.4m (DCP). Alternatively, if a wider verandah is sought, the front of the verandah can be located on the min. building setback line (4.5m in the example above) and there is no restriction on width.



Courtesy of McDonald Jones Homes

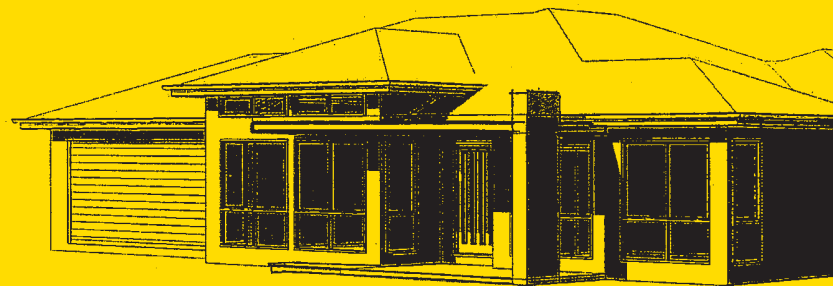

Courtesy of Vogue Constructions



Courtesy of Rawson Homes

Artist's impression

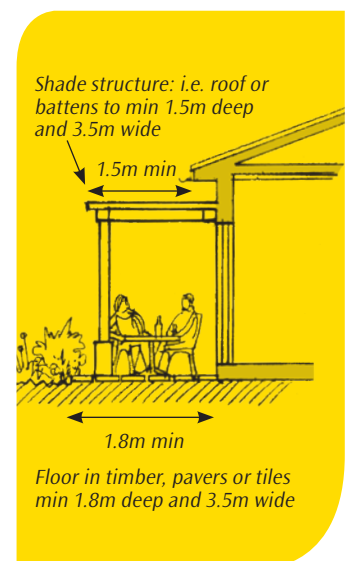

# 5. PLANNING YOUR HOME

## DESIGN INTENT

Create house layouts that relate well to the street, are designed to fit the lot, and maximise indoor/outdoor opportunities for amenity and climatic comfort throughout the year.

## EXPRESSION

- Design living areas with sunny front, rear and/or side courtyards for alfresco living.
- Create designs that allow for cross ventilation in hotter months.
- On corner lots consider main house entry from the secondary street to reduce circulation space.
- Two rooms, or the appearance of two rooms, should face the street.



One room to the street, a 'passive' house frontage, with no overlooking of the street.

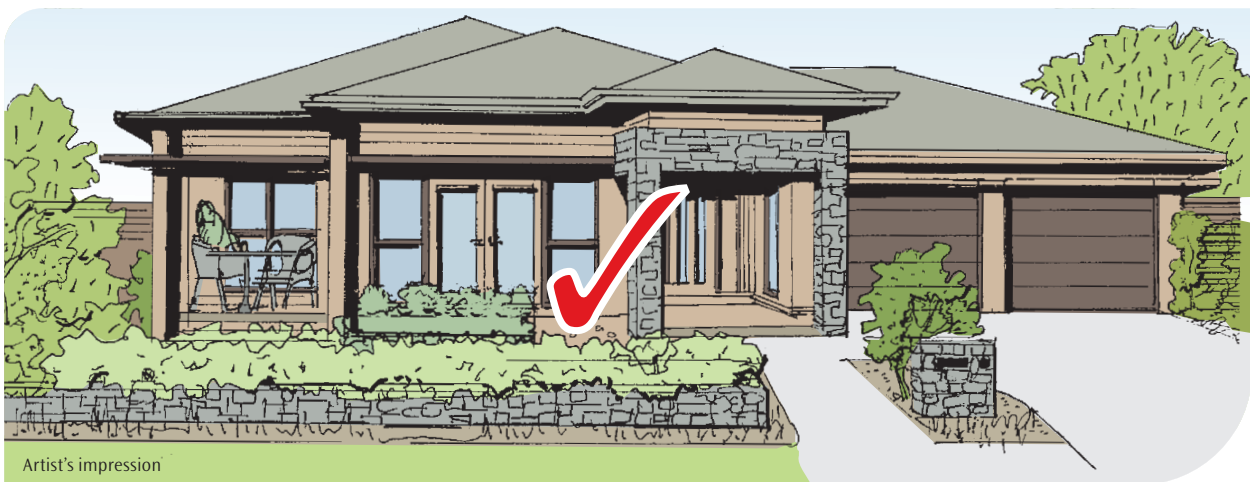

Two rooms to the street, an 'active' house frontage which overlooks the street.

## DESIGN REQUIREMENTS

**m** Represents a mandatory design requirement.

### Setbacks

- Setbacks are to be as defined in the DCP or Housing Code (whichever is used for approval).

### Dual Occupancy

- m** Dual Occupancy dwellings are only permitted on corner lots (Minimum lot size and width apply as defined in the DCP).

### Street interface

- m** For lots with frontages below 16m the garage door width is to be no greater than 50% of the overall dwelling frontage.
- m** For lots with frontages 16m, single storey homes must have two rooms or the appearance of two rooms facing the street. I.e. windows to each room facing the street.
- m** For lots with frontages of over 16m, single storey homes must have two rooms or one wider room facing the street (minimum 6.5m combined frontage not including the entry hall). An ensuite or walk in robe (WIR) are not considered rooms.
- m** For Dual Occupancies both street frontages are to be treated as primary frontages and guidelines apply to both dwellings.
- m** Dual Occupancies must have two rooms or the appearance of two rooms facing the street.
- m** Two storey homes do not require a two room frontage at ground level.
- m** Primary building entry or access to entry is to be clearly identifiable from the street.

### Indoor/outdoor living

- A principal open space of 24m<sup>2</sup> (6m x 4m min) is required (DCP and Code). It must relate to the primary living area of the home and should be relatively flat.

### Site coverage and landscaped area

- Site coverage and landscaped area are to be as defined in the DCP or Housing Code (whichever is used for approval) and as expressed on the 'Building Envelope Plan' in your contract.
- Front verandah/courtyard/alfresco can be included in the landscaped area calculation if approval sought under the Housing Code.

*Continued overleaf*

### **Building over easements**

The relevant authority for enquiries about building over service easements is Queanbeyan-Palerang Regional Council who are the control and consent authority – Council’s policy is detailed in ‘*Development adjacent to Water, Sewer and Stormwater Mains*’. An information factsheet ‘*Construction in the Vicinity of Easements – Summary of Requirements*’, can be found at [www.qcc.nsw.gov.au](http://www.qcc.nsw.gov.au), or ring (02) 6298 0244.

- Most types of construction are prohibited within easements, including dwellings, garages, decks, retaining walls and excavation/filling. However Some types of construction may be permissible within easements subject to QCC approval including carports, walls/fences, cantilevered overhangs, concrete slabs/driveways/hardstands, small trees/vegetation and car parking.
- The footings of all structures near easements are to be designed to pass the loading zone of influence beneath buried pipework. Concrete slabs and other hardstand surfaces are subject to design requirements including location of footings and construction joints.
- Demountable and non-demountable carports have a number of design requirements including height (2.1m clear for demountable, 2.7m for non-demountable), location of construction joints and distance between supports and buried pipework.

Refer to the Googong DCP to clarify all relevant planning controls such as setbacks, site coverage, private open space and landscaped areas required.

Note: Rear and/or side setbacks may differ if an easement is required. Diagrams provided are for information only and maybe subject to change by the consenting Planning Authority.

# TYPICAL BUILDING ENVELOPES



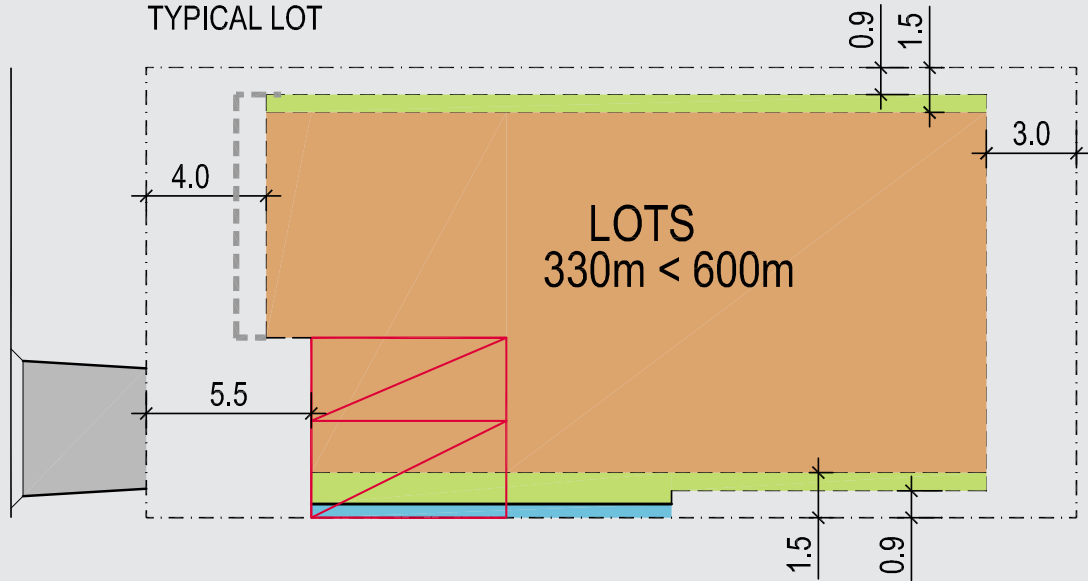



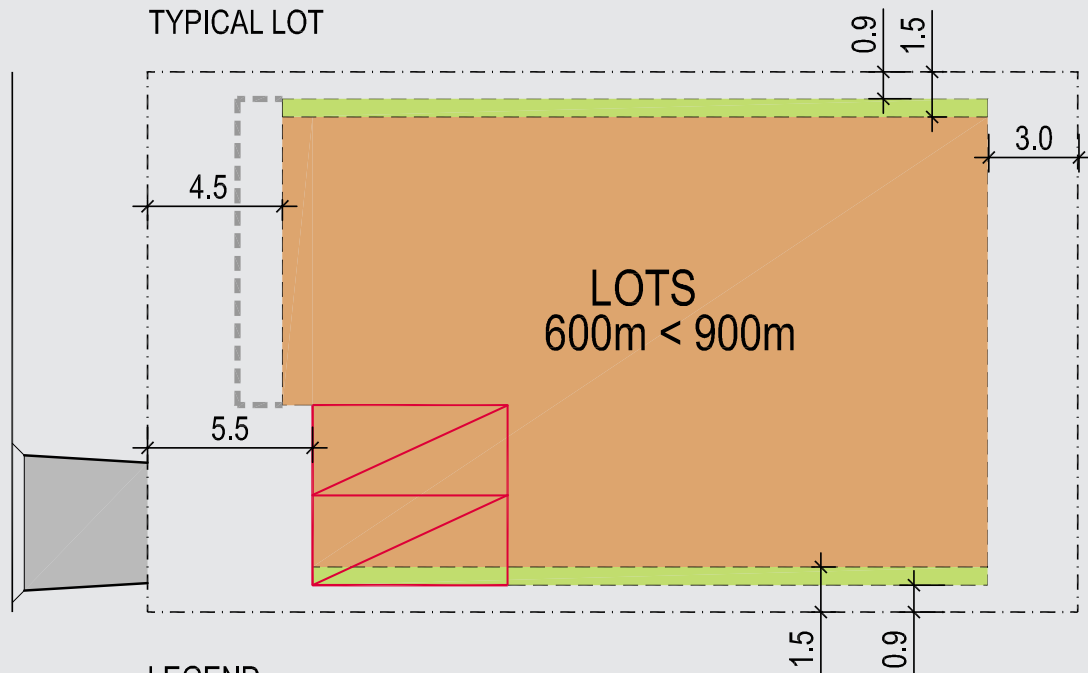

TYPICAL LOT

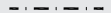

TYPICAL LOT

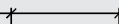

## LEGEND

-  Lot Boundary
-  General building envelope
-  Upper floor setback (side only)  
Refer DCP for upper floor rear setback
-  Zero Lot line  
(DCP :50% of depth of building single storey only)
-  Driveway crossover position
-  Garage
-  Setback from boundary
-  Articulation zone  
1.5m (max 40% width of dwelling)

## TYPICAL CORNER LOT BUILDING ENVELOPES

CORNER LOT

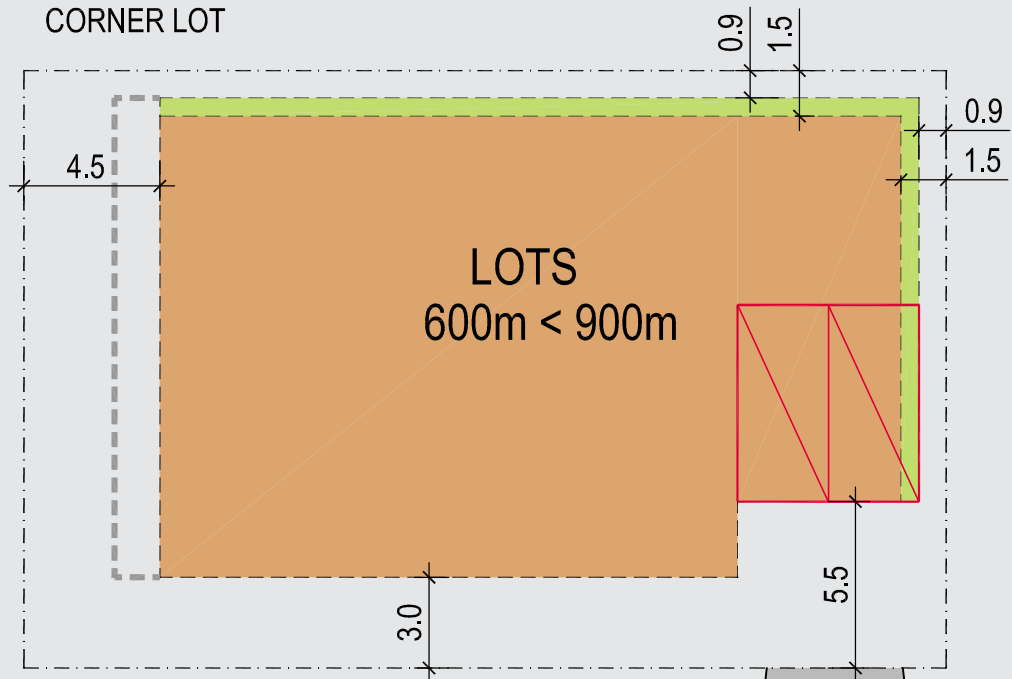

The front setback can be on either boundary irrespective of the front door location.

CORNER LOT

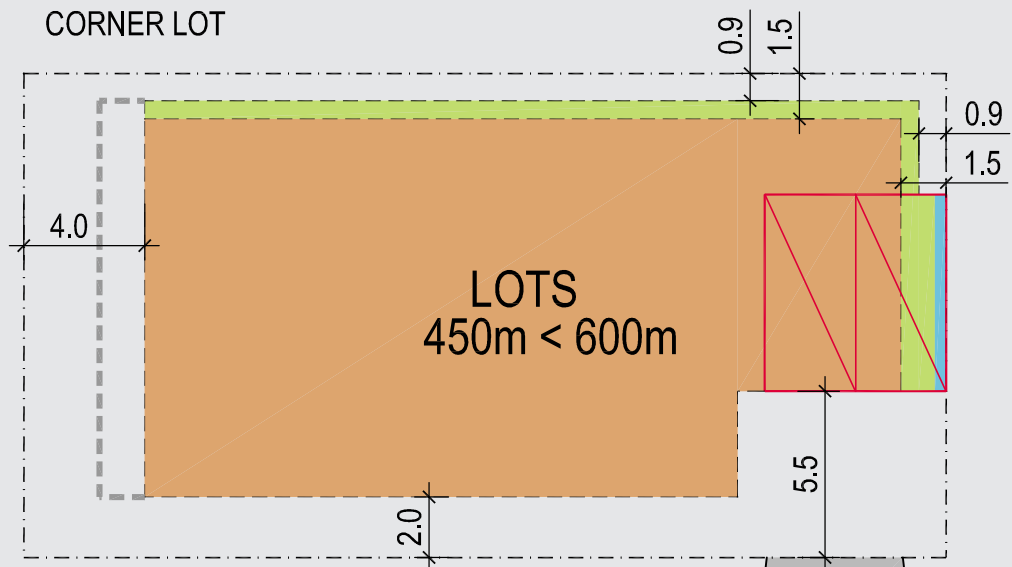

The front setback can be on either boundary irrespective of the front door location.

Refer to the Googong DCP to clarify all relevant planning controls such as setbacks, site coverage, private open space and landscaped areas required.

Note: Rear and/or side setbacks may differ if an easement is required. Diagrams provided are for information only and maybe subject to change by the consenting Planning Authority.



## TYPICAL BUILDING ENVELOPE – DUAL OCCUPANCY CORNER LOT

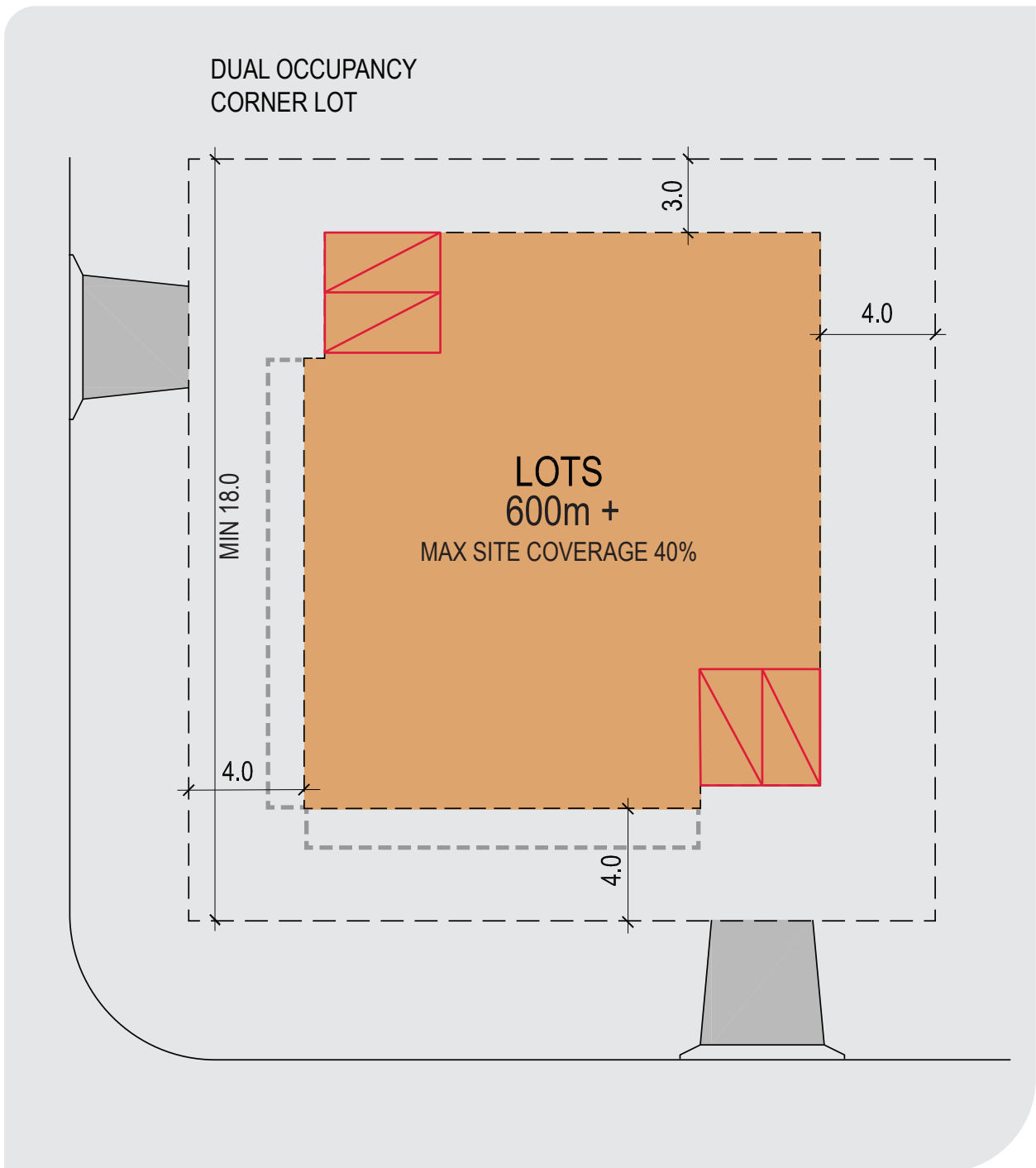

Refer to the Googong DCP to clarify all relevant planning controls such as setbacks, site coverage, private open space and landscaped areas required.

Note: Rear and/or side setbacks may differ if an easement is required. Diagrams provided are for information only and maybe subject to change by the consenting Planning Authority.

# 6. GARAGES AND DRIVEWAYS

## DESIGN INTENT

Reduce impact of garages from the street, and co-ordinate driveway material/colour with driveway crossings and footpath.

## EXPRESSION

- Garages to be set back from primary house frontage.
- The garage may be configured in any of the following manners:
  - a double garage with separate garage doors divided by a central column (encouraged).
  - a double width garage door.
  - one single garage and one parking space.
- Other garage forms, such as integrated carports will be considered on merit, based on location and street impact.
- Shading structures above/in front of garage doors will assist in reducing visual impact by visually receding garage frontage.
- Recess garage doors to create reveals to adjoining walls.



## DESIGN REQUIREMENTS

**m** Represents a mandatory design requirement.

### Garages

- m** Garages and carports must be constructed at the same time as the dwelling and must integrate with the dwelling in relation to design, materials and finish.
- m** Garages to be a minimum of 1.0m behind the main building line, and a minimum of 5.5m from the front boundary.
- m** Garage to house frontage is not to comprise more than 50% of the overall dwelling frontage.
- m** Panel lift / panel glide doors are required to street frontages, not roller style doors.
- Garages on corner lots to be accessed from the secondary street – driveway crossings are located in these positions for corner lots. Any variations to be at the discretion of the Googong Design Co-ordinator.
- Garage door colours are to complement the proposed house colours. Natural coloured timber finishes are encouraged. Avoid dark colours such as Colorbond® Monument.
- Prefabricated and metal clad garages are prohibited.

### Driveway

- m** Driveway to be constructed in concrete.
- m** Driveways are to be completed prior to the occupation of the home. Driveway is to include the verge driveway between the kerb and the lot boundary, as well as the on-lot component. Where relevant the verge driveway will be bisected by the public footpath, which is typically on one side of the street.
- Driveway colour within mid earth/grey range. Concrete to be coloured using oxides or similar pigment method (3% black oxide is recommended). Variations will be considered at the discretion of the Googong Design Co-ordinator.
- Driveway patterns: pebblecrete, exposed aggregate finish, stamped or spray-on patterns are not permitted.
- Driveway width at the boundary preferably 4.5m max, typically located near the Southernmost site boundary, or near the rear boundary of corner lots. The vertical kerb is pre-cut in the nominated crossover location for each lot. Variations to driveway locations may be acceptable and should be discussed with and approved by the Googong Design Co-ordinator.



# 7. BUILDING AND ROOF FORM

## DESIGN INTENT

Well proportioned and timeless building forms which create a strong presence to the street. Corner buildings to be given design emphasis to address both street frontages.

## EXPRESSION

### Building form

- Raise the building floor level above the street level where possible for street presence and surveillance.
- Solid base elements with lighter weight upper or projecting elements are encouraged.
- Generally two rooms facing the street, particularly for single storey homes.

### Roof form

- Roof forms, particularly to street frontages, to primarily be gables and hips. Skillion roofs are permitted to street frontages and minimum pitch and eaves requirements will apply.
- Generous eaves to create a strong shadow line.
- If skillions are proposed they should be incorporated to provide higher ceiling levels to living areas and to front entries. They should encourage more light penetration to northern and north eastern facades.
- Lower pitched roofs behind parapets such as garages are accepted.
- Lower pitched roofs for stylistic reasons are not permitted.
- Boxing out of skillion forms to street frontages are not permitted.

### Corner buildings

- Consider a two storey building form which can maximise the benefits of both frontages.
- Use either a gable facing both streets, a corner feature, additional height to single storey houses, a 'wrap-around' verandah, or a combination of these.
- Consider a house entry from the secondary street frontage to reduce internal circulation space.



## DESIGN REQUIREMENTS

**m** Represents a mandatory design requirement.

- m** A maximum of 8.5m in height from natural ground level to the top of the roof.
- m** Minimum ground floor to ceiling height of 2.55m, however 2.70m preferred, particularly for living areas.
- m** A minimum of 450mm eaves overhang is required for all roofs (preferably 600mm). Consider generous eaves with larger overhangs to shade north and west facing facades.
- m** Minimum roof pitch 22.5° (preferably 25°) for hipped and gable roofs.
- m** The minimum pitch for a skillion roof is 12° (preferably 15°). If a skillion is used to a street frontage or northern facing the minimum eaves depth is 600mm.
- m** If a combination of a skillion and gable is proposed (clerestory) the skillion roof form must pitch 18°. The gable form minimum roof pitch 12°.
- m** Corner lot dwellings must provide articulation to both primary and secondary street frontages, such as wrapping verandas, stepped wall planes and providing surveillance of both street frontages.
  - Generally two rooms to the street – see ‘5. Planning Your Home’.



# 8. OPENINGS AND ARTICULATION

## DESIGN INTENT

Establish street frontages that have well-proportioned elements, where the main entry is clearly recognisable from the street, key architectural components are highlighted, and articulation within the built form creates both a sense of light/shade and solid/void. Use appropriate detailing to highlight climate-responsive design, and break down the mass of the built form.

## EXPRESSION

- Vertically proportioned openings, windows, framing and doors (where height exceeds width).
- Recessed openings and reveals.
- Shading devices and screens.
- Mixture of lightweight and solid materials in expressing form.
- Generally light or white frames and trim to emphasise vertical proportions.
- Accentuated front entry detail.
- Natural finished timber for window framing is encouraged.
- Direct access to verandahs, porches, courtyards from living rooms is encouraged.

## DESIGN REQUIREMENTS

**m** Represents a mandatory design requirement.

- m** Window and door openings visible from the street are to generally establish vertical proportions – horizontal window slots are not encouraged. Basic 2 panel sliding window units are not permitted to the street frontage. Operable sliding glazed window units and associated side lights should have mullion spacing of between 700 – 1000mm to create a vertically proportioned window opening.
- m** Articulation of the primary street facing wall plane is required. Either by stepping the wall, or with the use of expressed structure, blades, wall finish treatments and materials. Wall lengths of more than 6m must be articulated.
- An 'articulation zone' is to be established within the front setback of 1.5m deep (NSW Housing Code and DCP) in front of building setback line. This area is to be used to articulate the house with elements including verandahs, courtyards, balconies, entry porches and sun-shades.





# 9. MATERIALS AND COLOURS

## DESIGN INTENT

Colours and materials that sit comfortably within the semi-rural context of Googong.

## DESIGN REQUIREMENTS

**m** Represents a mandatory design requirement.

### Walls

- m** A complementary mix of materials and colours is required within the built form of each dwelling. At least **two materials** or finishes are to be used to distinguish façade elements.
- m** Materials to be chosen from the following:
  1. Masonry in a painted, rendered or bagged finish
  2. Bricks
  3. Fibre cement sheeting or boarding (painted, coloured or rendered)  
Pre-finished metal profile wall cladding, hardwood cladding, architectural cladding  
Pre-finished panel systems may also be utilised on the facade.

Highlight/feature materials that compliment the house can include stone, stone cladding (larger units not thin stack stone).

### Bricks

- Please refer to brick selections from pages 75–77. Bricks may be selected from this list or have a similar look and colour. *Other style bricks may be permitted for feature wall applications and will be subject to the Design Co-ordinator approval.*
- Where face bricks are used there should be only one brick type for any building element.
- Single colour bricks with smooth face required, no mixes on a facade element
- Complete facades of brick with no contrasting elements are not permitted.
- Bricks with hearting, frit and shiny surfaces and rumbled bricks with rough edges are not generally permitted. No sandstock bricks will be permitted.

### Roofs

- m** Roof colour and material is to be chosen from the specified range, typically metal or flat profile tiled roofs in mid to darker grey and earthy tones, as shown in the examples.
- Very dark/black roofs and very light/bright or highly reflective roofs are not permitted.
- Variations will be considered at the discretion of the Googong Design Co-ordinator.

Googong Design Co-ordinator to approve the final proposed colours and materials palette as part of design approval.

The materials and colours shown opposite are representative of the Googong palette. For more detailed specifications see page 70 onwards.

### Balustrades

- Balustrades should generally be in masonry, metal or timber to match the house design. While glass balustrades are not generally consistent with the character sought, they will be considered on merit where detailed with posts and a handrail (horizontal metal or timber handrail section preferred) to create a framed appearance. Frameless glazing, and chrome/polished posts/rails are not permitted (use anodised, matt or brushed finishes).



## COLOURS AND MATERIALS

### STONE

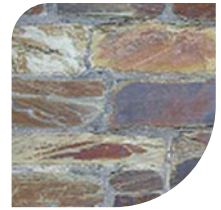

### PAINT

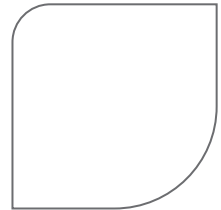
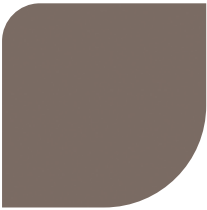

### BRICK



### METAL ROOF



### TILED ROOF



# 10. BUILDING ON SLOPING LOTS

## DESIGN INTENT

Minimise the amount of excavation to create an attractive house/garden and provide better relationship between indoor and outdoor spaces.

This will enhance the character of your street and avoid having streets dominated by retaining walls between lots.

## EXPRESSION

- Use a split-level building form and/or garage under where slope dictates, rather than trying to force a flat plan onto a sloping lot.
- Choose a house design which responds to slope with a half or full level split.
- Preferably site the garage on the lower part of the lot.
- Front-to-back slopes: stepping your house by either a half or full floor level will reduce the height and visual impact of slopes or retaining walls at the front and back of your lot, and allow for a better relationship between house and garden.
- Cross-slope lots: a retaining wall/site bench in the centre of the house avoids visible retaining walls on lot boundaries.

## DESIGN REQUIREMENTS

**m** Represents a mandatory design requirement.

### Retaining walls

- Maximum height of any retaining walls is 1.0m.
- Terracing of retaining walls is encouraged where planting is used between and to the front of the proposed walls, to breakdown the visual impact of the change of level (minimum 0.5m separation between walls).
- Retaining walls that are visible to the public must be constructed in mid-dark grey stone, or stone finish blockwork or rendered masonry.
- Timber retaining is not encouraged, and can only be used where not visible from the street or public open space.





**Cross Slope Lots:** a retaining wall or step in centre of the house avoids visible retaining walls on lot boundaries.

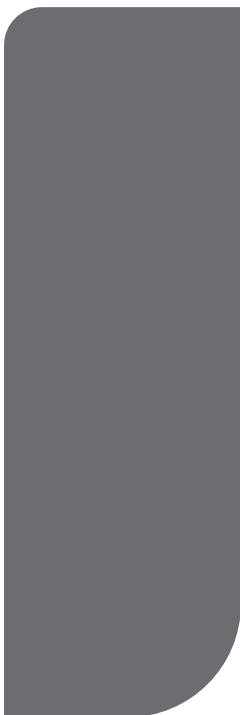

**Front to Back Slopes:** this corner lot steps from front to back and creates less visible retaining structure at the front and back of the lot.

# 11. EXTERNAL ELEMENTS

## DESIGN INTENT

External elements like plumbing and air conditioning can have significant visual impacts on your home and lot due to their location and appearance. The Guidelines aim to minimise their impact through defining appropriate design and location.

## DESIGN REQUIREMENTS

 Represents a mandatory design requirement.

### Air conditioning

Your house should be designed to take full advantage of natural breezes and micro-climate, and utilise passive heating and cooling to minimise the need for and use of air conditioning. Where air conditioning is used the following applies:

- No air conditioning equipment other than evaporative units may be located on the roof of any dwelling, and units must be located away from public view.
- Roof, wall and window mounted air conditioning units will not be permitted where they are visible from streets or public areas.
- All ductwork must be installed to R1.5 and refrigerant lines are to have 20mm minimum insulation.
- Split system air-conditioning units must be mounted below 1.8m height on an external wall.
- Evaporative air conditioning systems must not be located so as to be visible from the street and should be of a low profile type and be well set back from the front facade.

### Plumbing

- All plumbing except downpipes is to be contained within the wall cavity.

### Solar Panels

- Solar panels are to be located on the roof, ideally where they are not visible from public areas. Where visible from public areas or on other parts of the building, solar panels are to be integrated into/aligned with roof, and will be assessed on their visual merits.
- Solar panels must be integrated into the roof form. Where the roof pitch does not allow efficient solar collection, applications will be assessed on their merits.
- The water storage tanks associated with solar hot water systems must not be on the roof.

### Antennae and satellite dishes

- Where antennae and dishes are required these shall be mounted away from public view, and located to minimise visual impact.

### Swimming pools

- Swimming pools are permissible in the back garden where they are not visible from the street.
- Pumps, filters and other mechanical equipment including solar water heaters and associated plumbing to be located away from public view.

### Outbuildings and sheds

Garden sheds and enclosures are permissible on lots as long as they are:

- maximum height of 2.4m
- maximum floor area 12m<sup>2</sup>
- clad finished or Colorbond material or similar matched to residence in non-reflective material
- located in the rear yard and not visible from roads or public places.

### Rainwater tanks

- **m** Minimum rainwater tank size is 2000 litres for Stages 1, 2 and 3. For Stage 4 and onwards, the minimum size tank is 2000 litres for 330m<sup>2</sup> to 479m<sup>2</sup> lots and a minimum size of 4000 litres for 480m<sup>2</sup> to 2000m<sup>2</sup> lots.
- Tank located so as not to be visible from any street or public place.
- Colour of tank and associated plumbing to integrate with the colour scheme of the house. Refer to Googong plumbing guide for details.

### Gas meter, electrical switchboard, garbage bin

- Meter boxes and visible services should be located away from public view, preferably recessed on a side wall and be painted to match the wall.
- Garbage bins are to be stored on your property out of sight from the street or public place.



# GOOGONG CENTRAL DESIGN GUIDELINES





# PART THREE

**SUSTAINABLE LIVING**

# SUSTAINABLE LIVING

## DESIGN INTENT

As a completely new township Googong presents the ideal opportunity to incorporate a range of sustainable living initiatives from the outset. Sustainability has been a driving force of the Googong masterplan where energy and water efficiency are part of a sustainable system.

This section has been split into three sections:

- Sustainable design requirement summary
- Water management design requirements
- Energy design requirements.

Googong will be so water efficient, its 16,000 residents will use the same amount of water as just 6,500 residents in an average Australian community.

## SUSTAINABLE DESIGN REQUIREMENTS

**m** Represents a mandatory design requirement.

- m** All new developments under NSW regulation are required to comply with the NSW Government building sustainability index – BASIX. BASIX sets targets to limit energy and water consumption. It also sets minimum performance levels for the thermal comfort of a dwelling. These requirements are assessed using the online BASIX tool.
- m** Compliance under BASIX is demonstrated via a BASIX certificate. This certificate needs to be submitted along with your development application for a new home (or alteration to an existing home).
- m** You are required to submit your BASIX certificate to the Googong Design Co-ordinator for endorsement of water and energy targets prior to submission of a Development Application (DA) or Complying Development Certificate (CDC).





## GOOGONG WATER AND ENERGY TARGETS

**m** Represents a mandatory design requirement.

**m** Googong, water and energy are higher than other residential developments in the same area. Googong BASIX targets are:

- **For water: 50% minimum saving**
- **For energy: 40% minimum saving**

This is important, as these are not specified in the BASIX online tool. You may receive a pass on your certificate but may not pass the Googong Targets, which are requirements for planning approval.

Before you submit your certificate, make sure the targets in 'Project scope' (refer to highlighted box) are **50 or above for water and 40 or above for energy**.

 <p><b>BASIX</b> Certificate Building Sustainability Index <a href="http://www.basix.nsw.gov.au">www.basix.nsw.gov.au</a></p>																																								
<p><b>Single Dwelling</b></p> <p>Certificate number: 497671S</p> <p>This certificate confirms that the proposed development will meet the NSW government's requirements for sustainability, if it is built in accordance with the commitments set out below. Terms used in this certificate, or in the commitments, have the meaning given by the document entitled "BASIX Definitions" dated 29/06/2009 published by Planning &amp; Infrastructure. This document is available at <a href="http://www.basix.nsw.gov.au">www.basix.nsw.gov.au</a></p> <p>Director-General Date of issue: Tuesday, 11 March 2014 To be valid, this certificate must be lodged within 3 months of the date of issue.</p>																																								
																																								
<p><b>SAMPLE ONLY</b></p>																																								
<table border="1"> <thead> <tr> <th colspan="3">Project summary</th> </tr> </thead> <tbody> <tr> <td>Project name</td> <td colspan="2">Hastings House</td> </tr> <tr> <td>Street address</td> <td colspan="2">23 Smith Street Bonny Hills 2445</td> </tr> <tr> <td>Local Government Area</td> <td colspan="2">Hastings Council</td> </tr> <tr> <td>Plan type and plan number</td> <td colspan="2">deposited 6464664</td> </tr> <tr> <td>Lot no.</td> <td colspan="2">654654</td> </tr> <tr> <td>Section no.</td> <td colspan="2">76</td> </tr> <tr> <td>Project type</td> <td colspan="2">separate dwelling house</td> </tr> <tr> <td>No. of bedrooms</td> <td colspan="2">2</td> </tr> <tr> <th colspan="3">Project score</th> </tr> <tr> <td>Water</td> <td>✓ 58</td> <td>Target 40</td> </tr> <tr> <td>Thermal Comfort</td> <td>✓ Pass</td> <td>Target Pass</td> </tr> <tr> <td>Energy</td> <td>✓ 43</td> <td>Target 40</td> </tr> </tbody> </table>		Project summary			Project name	Hastings House		Street address	23 Smith Street Bonny Hills 2445		Local Government Area	Hastings Council		Plan type and plan number	deposited 6464664		Lot no.	654654		Section no.	76		Project type	separate dwelling house		No. of bedrooms	2		Project score			Water	✓ 58	Target 40	Thermal Comfort	✓ Pass	Target Pass	Energy	✓ 43	Target 40
Project summary																																								
Project name	Hastings House																																							
Street address	23 Smith Street Bonny Hills 2445																																							
Local Government Area	Hastings Council																																							
Plan type and plan number	deposited 6464664																																							
Lot no.	654654																																							
Section no.	76																																							
Project type	separate dwelling house																																							
No. of bedrooms	2																																							
Project score																																								
Water	✓ 58	Target 40																																						
Thermal Comfort	✓ Pass	Target Pass																																						
Energy	✓ 43	Target 40																																						
<table border="1"> <thead> <tr> <th colspan="2">Certificate Prepared by</th> </tr> </thead> <tbody> <tr> <td>Name / Company Name:</td> <td>Testing ply ltd</td> </tr> <tr> <td>ABN (if applicable):</td> <td>11 222 333 444</td> </tr> </tbody> </table>		Certificate Prepared by		Name / Company Name:	Testing ply ltd	ABN (if applicable):	11 222 333 444																																	
Certificate Prepared by																																								
Name / Company Name:	Testing ply ltd																																							
ABN (if applicable):	11 222 333 444																																							
<p>BASIX Planning &amp; Infrastructure <a href="http://www.basix.nsw.gov.au">www.basix.nsw.gov.au</a> Version: 6.28 / CASUARINA_2_23_0_1 Certificate No.: 497671S Tuesday, 11 March 2014 page 1/8</p>																																								

## USING BASIX

The following steps will help you complete a BASIX certificate for water and energy:

1. Go to [www.basix.nsw.gov.au](http://www.basix.nsw.gov.au)
2. First time users will need to register their details and set up a username and password. Once you have done this, you can login to BASIX (from the homepage) at any time.
3. Download and read the **Data Input Checklist** (for single dwellings). These can be found under 'BASIX help notes' then 'New to BASIX'. It is important that you collect all the details in this form for energy and water prior to step 4.
4. Check your **Data Input Checklist** against the suggested water and energy management design requirement sections of this guideline. Modify your checklist if required.
5. Once you have completed the steps above log into BASIX and start a new project.
6. Enter the details of your house. Click '**calculate**' or check '**status**' to see if you meet the necessary requirements for Googong.
7. Once you are finished entering the details, review your commitments.
8. If you are happy that you can meet your commitments, print and pay for your BASIX Certificate.
9. Attach your certificate to your house plans and submit to the Googong Design Co-ordinator for endorsement of the water and energy targets.

### Important notes

Your BASIX certificate is valid for 3 months, prior to submission to council or accredited certifier. If your BASIX certificate is not lodged within 3 months you will need to generate a new certificate. This will incur additional fees.

For **thermal comfort** Googong households will need to achieve a **Pass**. Thermal comfort assessments can be completed in a variety of modes: Do-It-Yourself (DIY), rapid method or simulation method. It is recommended that the **simulation method** is used for Googong dwellings. To do this you will need to employ an **Accredited Assessor** who has been accredited by an **Accrediting Organisation**. For more information: [basix.nsw.gov.au](http://basix.nsw.gov.au)

## WATER MANAGEMENT – DESIGN REQUIREMENTS

**m** Represents a mandatory design requirement.

### Summary

- m** Housing at Googong is to achieve a minimum 50% reduction in water.
- m** All dwellings in Googong will be connected to the recycled water supply for toilets and outdoor irrigation. Refer to diagram 1 – Potable and non-potable water uses at Googong and to Queanbeyan-Palerang Regional Council Plumbing Standards for Googong.
- m** All houses on lots 330m<sup>2</sup> to 479m<sup>2</sup> will need to install a 2000 litre rainwater tank as a minimum for washing machine use. Lots of 480m<sup>2</sup> or above, will need to install a 4000 litre rainwater tank, as a minimum. Refer to Queanbeyan-Palerang Regional Council 'Googong Plumbing Standard'.
- m** The colour of the tank and associated plumbing is to integrate with the colour scheme of the house, and be located so as not to be visible from any street.
- m** A BASIX certificate is to be submitted to the Googong Design Co-ordinator and as part of your DA/CDC application detailing compliance with the minimum 50% reduction in water consumption.

**Diagram 1 – Potable and non-potable water uses at Googong**

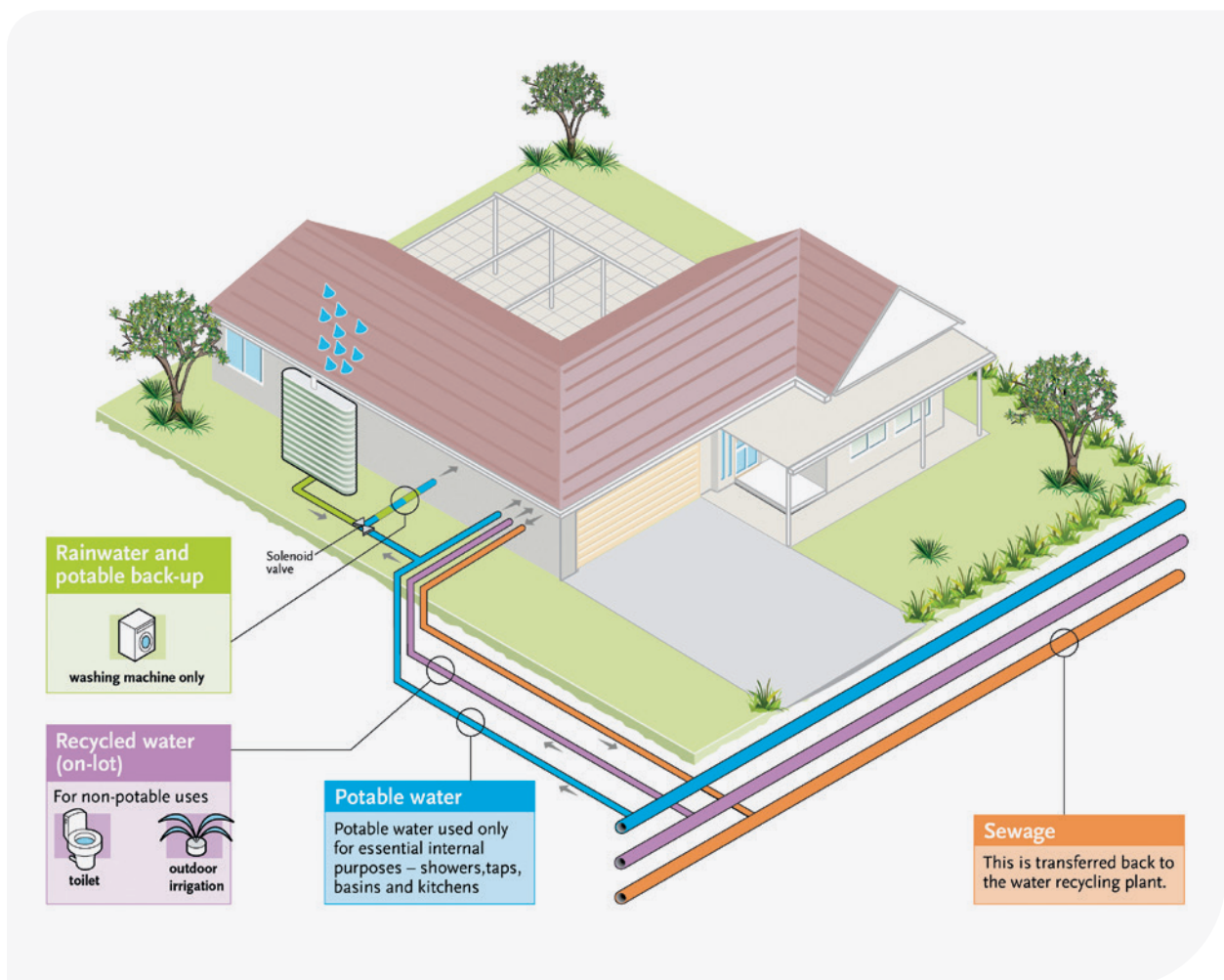



## MEETING BASIX WATER TARGETS

The following table is provided to help you with the online BASIX tool and achieving the 50% water target for Googong. It has been designed to reflect the order of the questions in the online BASIX tool. The recommendation column outlines minimum standards or suggestions. The information in the mandatory columns are required to ensure you meet the minimum water targets for Googong.

### REMEMBER – GOOGONG TARGETS HIGHER!

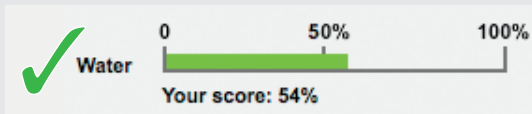

#### Correct Googong water target



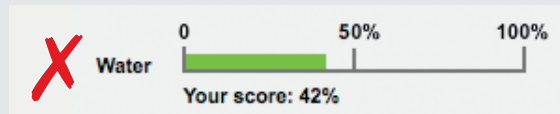



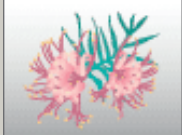

#### Incorrect Googong water target



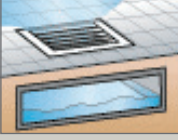
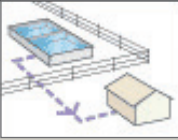

Remember water targets in your area are 40% you will need to reach 50%.

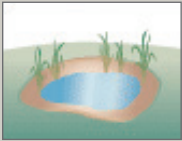
Options	Recommendations	Mandatory
<b>Landscape</b>		
Garden and Lawn 	N/A	N/A
Indigenous species 	Gardens should predominantly plant low-water-use plant species	N/A
<b>Fixtures</b>		
Toilets 	Minimum 3 star (>6 but <=7.5 L/min)	N/A
Showerheads 	Minimum 3 star	N/A

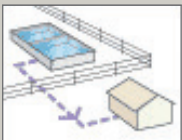
Options	Recommendations	Mandatory
<b>Fixtures continued</b>		
Kitchen taps 	Minimum 3 star	N/A
Bathroom taps 	Minimum 3 star	N/A
<b>Alternative Water</b>		
Rainwater tank 	N/A	Select <b>Yes</b> to: Are you installing a rainwater tank?  <b>Note:</b> Single dwellings and semi detached dwellings are required to have a rainwater tank.
Stormwater tank 	N/A	Select <b>NO</b> to: Are you installing a stormwater tank?
Reticulated alternative recycled water 	N/A	Select <b>Yes</b> to: Is there a reticulated alternative water supply (provided by a water utility) available?  <b>Note:</b> All dwellings in Googong are required to connect to the recycled water supply for toilet and outdoor irrigation. Refer Queanbeyan-Palerang Regional Council 'Googong Plumbing Standards'.
Greywater 	N/A	Select <b>NO</b> to: Are you installing a greywater treatment system? Are you installing a greywater diversion system?

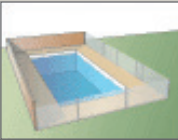
Options	Recommendations	Mandatory
Private Dam 	N/A	Select <b>NO</b> to: Will you be using a private dam as an alternative water supply?
Hot water recirculation or diversion system	N/A	Select <b>NO</b> to: Do you intend to install a hot water recirculation or diversion system?
Alternative water details		
Rainwater tank 	N/A	<p>You will need to enter a minimum <b>2000 litre tank</b> where the tool asks: what is the size of the rainwater tank?</p> <p>Select <b>NO</b> to: Will the overflow be diverted to a stormwater tank?</p> <p><b>Note:</b> The minimum water tank size is 2000 litres for stages 1, 2 and 3. Refer to Queanbeyan-Palerang Regional Council plumbing standards for Googong.</p> <p>If your house is 480m<sup>2</sup> or above you will need to install a <b>4000 litre tank</b> as a minimum.</p>
Reticulated alternative recycled water 	N/A	<p>You will need to select <b>Googong (proposed)</b> from the drop down menu available here.</p> <p>Googong has a recycled water supply, and all homes on lots above 330m<sup>2</sup> are required to connect.</p>
Alternative water uses		
Garden and lawn	N/A	<p>Select: <b>Reticulated alternative water supply</b> from drop down menu in BASIX.</p> <p><b>Note:</b> All outdoor taps at Googong will be plumbed to recycled water – refer to Googong Plumbing Standards.</p>
All toilets	N/A	<p>Select: <b>Reticulated alternative water supply</b> from drop down menu in BASIX.</p> <p>Note: All toilets at Googong will be plumbed to recycled water – refer to Googong Plumbing Standards.</p>

Options	Recommendations	Mandatory
<p>Laundry</p>	<p>N/A</p>	<p>Select: <b>Rainwater tank</b> from drop down menu in BASIX.</p> <p><b>Note:</b> All washing machines in Googong will be plumbed to the rainwater tank – refer to Googong Plumbing Standards.</p> <p>Laundry basins will be plumbed to the potable water supply.</p>
<p>All hot</p>	<p>N/A</p>	<p>Select: <b>Town water supply</b> from drop down menu in BASIX.</p> <p><b>Note:</b> All hot water taps in Googong will be plumbed to the potable water source – refer to Googong Plumbing Standards.</p>
<p>Drinking and other household</p>	<p>N/A</p>	<p>Select: <b>Town water supply</b> from drop down menu in BASIX</p> <p><b>Note:</b> All drinking water and other household taps (shower, laundry basin, kitchen) in Googong will be plumbed to the potable water source – refer to Googong Plumbing Standards.</p>
<p><b>Pools and Spas</b></p>		
<p>Swimming pool</p> 	<p>Outdoor pools should be covered.</p> <p>Chlorine pools are preferred.</p> <p>Water source: Town water supply.</p>	<p>N/A</p>
<p>Outdoor spa</p> 	<p>Outdoor spas should be covered.</p> <p>Chlorine spas are preferred.</p> <p>Water source: Town water supply.</p>	<p>N/A</p>



## MEETING BASIX ENERGY TARGETS

**m** Represents a mandatory design requirement.

### BASIX energy target recommendations

There are many opportunities for energy reduction in the design, building and ongoing management of your home. The following table can be used to help you achieve or exceed the required 40% energy savings.

#### Summary

- m** Housing at Googong is to achieve a minimum **40% reduction** in energy consumption compared to the 25% saving normally required of new homes in Queanbeyan, as measured by BASIX.
- m** A BASIX certificate is to be submitted to the Googong Design Co-ordinator and as part of your DA/CDC application detailing compliance with the minimum 40% reduction in energy consumption.

If you follow all the recommendations you will exceed the target. If you want to achieve the minimum target we have provided some suggestions in the minimum standards column.

### REMEMBER – GOOGONG TARGETS ARE HIGHER!

#### Correct Googong energy target

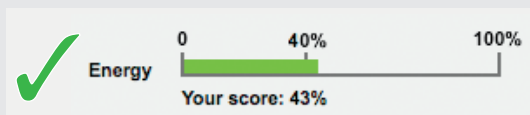



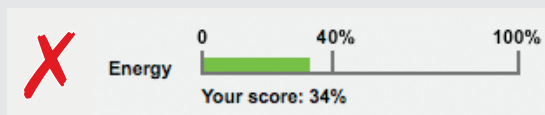

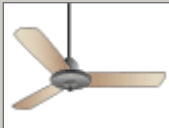
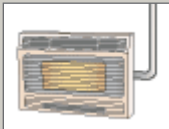

#### Incorrect Googong energy target

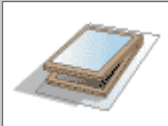
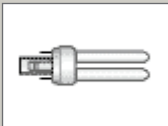
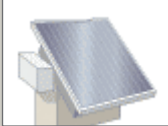

Remember water targets in your area are 25% you will need to reach 40%.

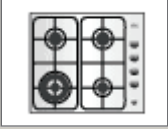
Options	Recommendations
<b>Hot water</b>	
Hot water system 	Solar gas boosted hot water system with a minimum performance of 32 RECs for the standard detached dwelling.
<b>Heating and cooling system</b>	
	Install ceiling fans for living rooms and bedrooms.
	For living room – Gas fixed flue heater, 5 star. For bedroom – air-con (minimum 4 star 1-phase of EER.4.0 for 3-phase).

Options	Recommendations
<p>Zoning</p>	<p>It is recommended that your air conditioning is day-night zoned between bedrooms and living area</p>
<p><b>Ventilation</b></p>	
<p>Bathroom exhaust</p> 	<p>Individual fan ducted – manual on timer.</p>
<p>Kitchen exhaust</p> 	<p>Individual fan ducted – manual on timer.</p>
<p>Laundry exhaust</p> 	<p>Individual fan ducted – manual on timer.</p>
<p><b>Lighting</b></p>	
<p><b>Natural Lighting</b> Windows and/or skylights</p> 	<p>Provide for natural lighting through skylights or windows, especially within kitchen and bathrooms.</p>
<p><b>Artificial Lighting</b> Energy efficient lamps</p> 	<p>Rooms primarily lit by compact fluorescent, fluorescent or LED lamps.</p> <p><b>Note:</b> this section is not optional.</p>
<p><b>Alternative energy</b></p>	
<p>Photovoltaic</p> 	<p>Install, at a minimum, a 1.5 kW photovoltaic system that converts sunlight to electricity.</p>

Options	Recommendations
<b>Other</b>	
<p>Cooktop/oven</p> 	<p>Gas cooktop and electric oven or gas cooktop and gas oven.</p>
<p>Refrigerator space</p> 	<p>Design a well ventilated refrigerator space.</p>
<p>Outdoor clothes drying line</p> 	<p>Install an outdoor clothes line.</p>
<p>Indoor clothes drying line</p> 	<p>Install an indoor clothes line.</p>

# GOOGONG CENTRAL DESIGN GUIDELINES





# PART FOUR

THE GOOGONG PALETTE

# FRONT GARDEN DESIGNS

There are nine front garden designs, which have been developed to reflect the character of Googong and to give you choice in relation to lifestyle, maintenance and home design. There are three garden types, Productive, Architectural and Native, and for each of these three characters, Traditional, Contemporary and Ecological, creating the nine designs.

These designs are indicative, and reflect the front garden quality and character expected at Googong – should you choose to amend these, or develop alternative designs you can consult with the Googong Design Co-ordinator for advice, and you will require Googong Design Guidelines approval prior to submitting landscape plans with your Development/Complying Development application.



# 1. ECOLOGICAL PRODUCTIVE GARDEN

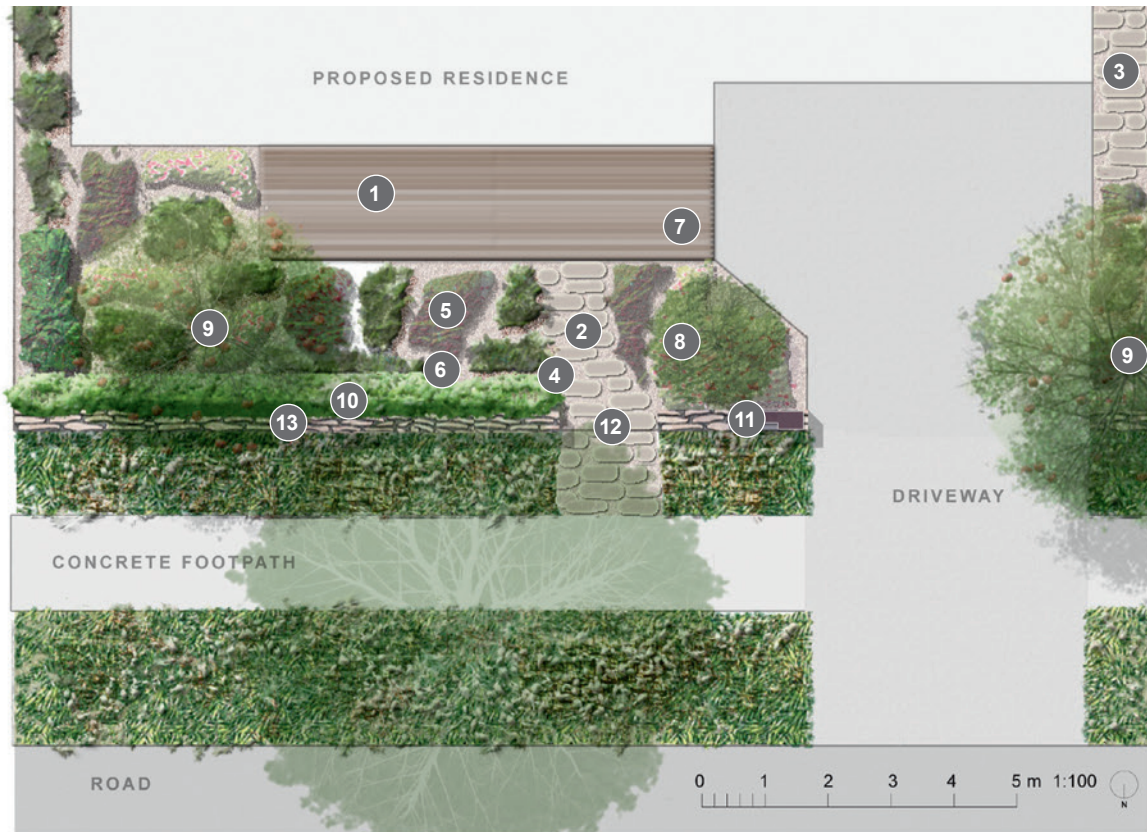

## BOTANICAL NAME

*Malus*

*Persimmon*

*Rosemarinus officinalis*

*Feijoa sellowiana*

*Dianella caerulea*

*Lomandra longifolia*

*Echinacea*

*Chrysocephalum apiculatum*

*Nasturtium*

## COMMON NAME

Apple Tree (1)

Persimmon Tree (1)

Rosemary

Pineapple Guava

Paroo Lily

Spiny-head Mat-rush

Echinacea

Yellow Buttons

Nose-twister

1. Timber hardwood veranda recommended – 1.8m w
2. Split face stone front path – 1.2m w
3. Split face stone side path – 0.9m w
4. No garden edging
5. Straw mulch to planted beds
6. Decomposed granite mulch between planted beds
7. Personalisation Opportunity
8. Productive/Medicinal planting
9. 2 x Exotic multi-stemmed fruit trees – 45L
10. Front boundary edge planting (e.g. Rosemary, Lilly Pilly)
11. Letterbox location
12. Single gate – 1.2m width
13. Low retaining wall or edge strip

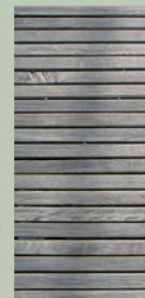
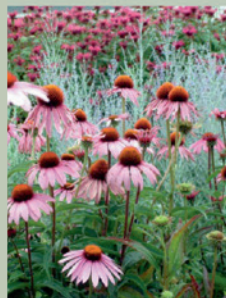

## 2. TRADITIONAL PRODUCTIVE GARDEN

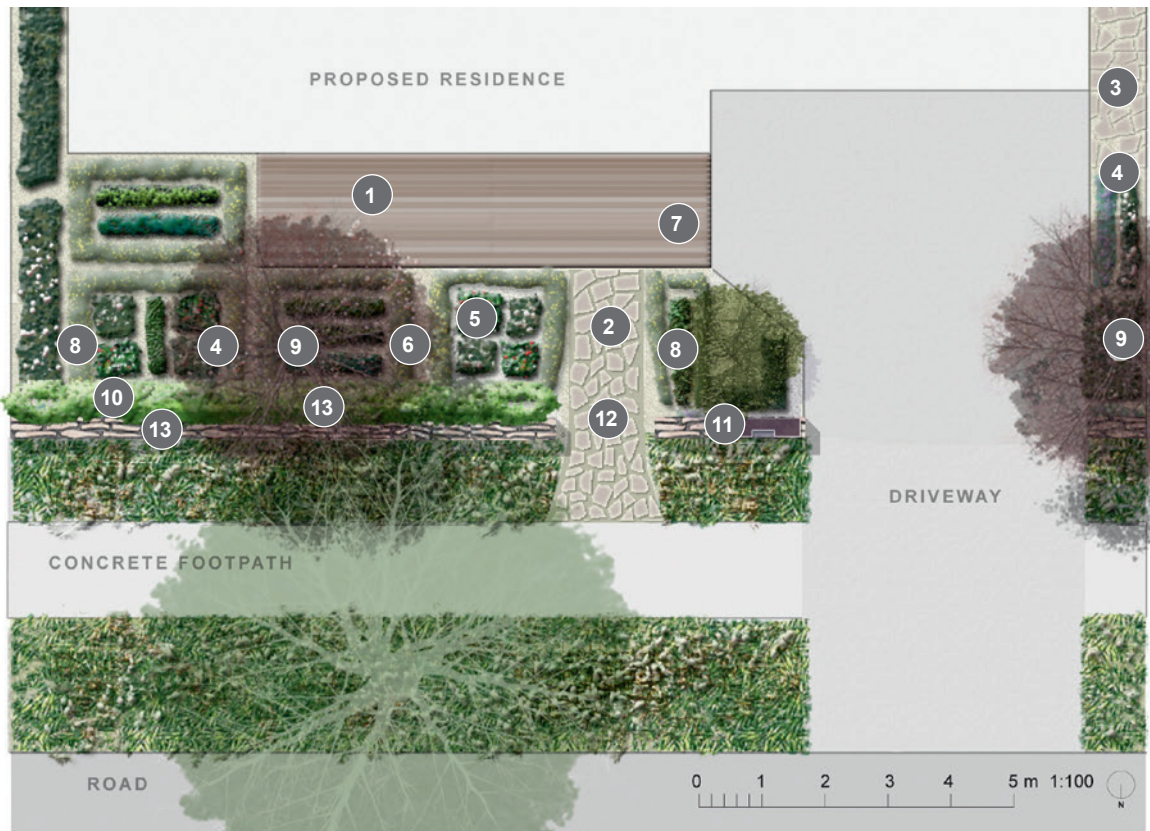

### BOTANICAL NAME

*Prunus*  
*Prunus*  
*Rosemarinus officinalis*  
*Laurus nobilis*  
*Rose*  
*Fragaria*  
*Chamomile*  
*varies*

### COMMON NAME

Plum Tree (1)  
 Cherry Tree (1)  
 Rosemary  
 Bay Tree  
 Rose  
 Strawberry  
 Chamomile  
 Mixed herbs + leaf vegetables

1. Timber hardwood veranda recommended – 1.8m w
2. Split face stone front path – 1.2m w
3. Split face stone side path – 0.9m w
4. Timber garden edging (not to boundary or retaining wall)
5. Straw mulch to planted beds
6. Decomposed granite mulch between planted beds
7. Personalisation Opportunity
8. Productive/Medicinal planting
9. 2 x Exotic multi-stemmed fruit trees – 45L
10. Front boundary edge planting (e.g. Rosemary, Laurus)
11. Letterbox location
12. Single gate – 1.2m width
13. Low retaining wall or edge strip





### 3. CONTEMPORARY PRODUCTIVE GARDEN



**BOTANICAL NAME**

*Pyrus*

*Pyrus pyrifolia*

*Rosemarinus officinalis*

*Feijoa sellowiana*

*Kale*

*varies*

**COMMON NAME**

Pear Tree (1)

Nashi Pear Tree (1)

Rosemary

Pineapple Guava

Kale

Mixed herbs + basic vegetables

1. Timber hardwood veranda recommended – 1.8m w
2. Honed stone front path – 1.2m w
3. Honed stone side path – 0.9m w
4. Recycled steel & stone garden edging
5. Lucerne/straw mulch to planted beds
6. Decomposed granite mulch between planted beds
7. Personalisation Opportunity
8. Herbs and common kitchen vegetables
9. 2 x Standard Fruit Trees – 45L
10. Front boundary edge planting (e.g. Rosemary, Feijoa)
11. Letterbox
12. Single gate – 1.2m width
13. Low retaining wall or edge strip



## 4. ECOLOGICAL ARCHITECTURAL GARDEN

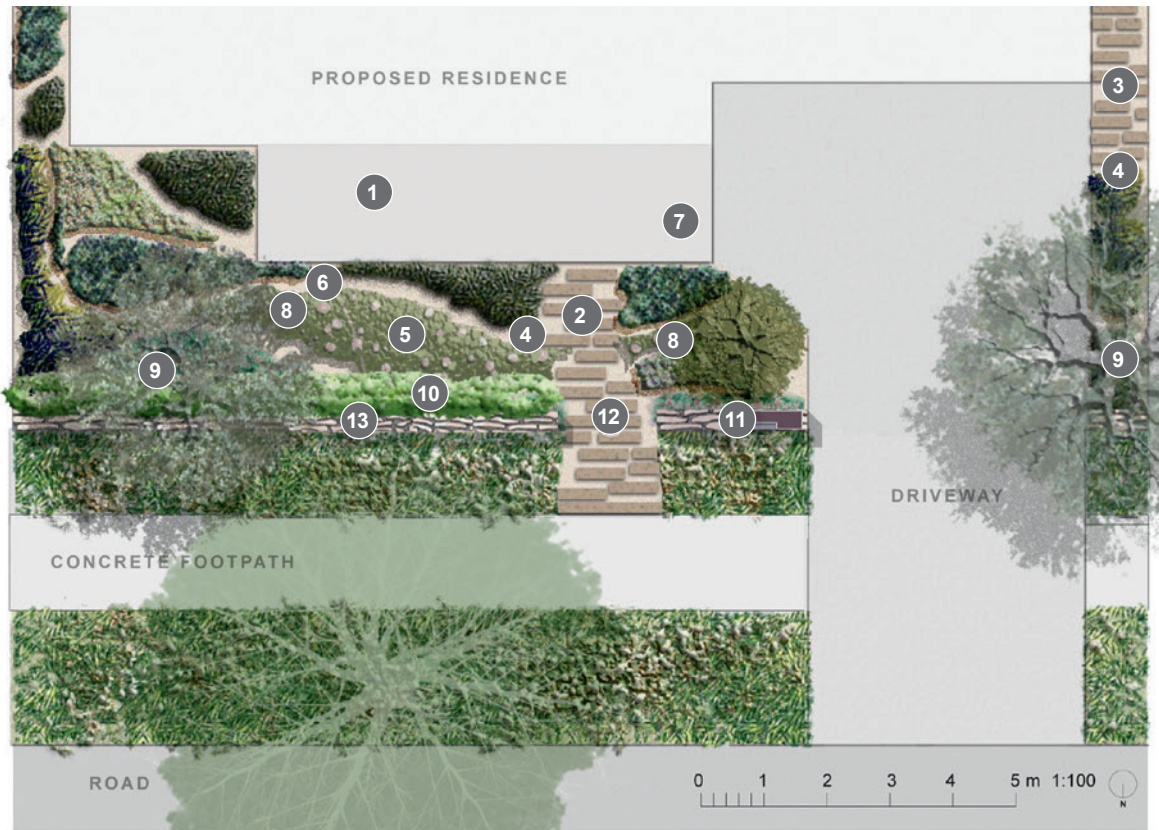

### BOTANICAL NAME

*Eucalyptus paciflora*

*Eucalyptus scoparia*

*Sedum* sp.

*Protea* 'White Mink'

*Echinacea*

*Pennisetum nafray*

*Liriope* 'Evergreen Giant'

*Phormium tenax*

*Ajuga reptans*

### COMMON NAME

Snow Gum Tree (1)

Wallangandra White Gum Tree (1)

Sedum

White Mink Protea

Echinacea

Swamp Foxtail

Evergreen Giant Turf Lily

Flax

Blue Bugle

1. Concrete veranda + agg edge recommended – 1.8m w

2. Exposed aggregate paver front path – 1.2m w

3. Exposed aggregate paver side path – 0.9m w

4. No path or garden edging

5. Site aggregate mulch to planted beds

6. Site aggregate mulch between planted beds

7. Personalisation Opportunity

8. Diverse plant palette

9. 2 x Native multi-stemmed trees – 75L

10. Front boundary edge planting

11. Letterbox

12. Single gate – 1.2m width

13. Low retaining wall or edge strip

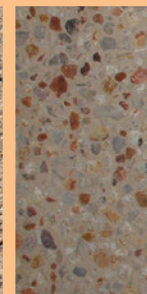
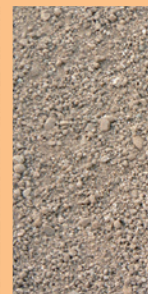

## 5. TRADITIONAL ARCHITECTURAL GARDEN



### BOTANICAL NAME

*Betula jacquemontii*

*Sedum sp.*

*Lomandra 'Tanika'*

*Photinia glabra*

*Euphorbia*

*Liriope muscari*

*Hardenbergia violacea*

*Osteospermum*

### COMMON NAME

Himalayan Birch Tree (3)

Sedum

Tanika Mat-rush

Small Leaf Photinia

Spurge

Turf Lily

False Sarsaparilla

Cape Daisy

1. Concrete veranda + brick edge recommended – 1.8m w
2. Saw cut concrete front path w brick edge – 1.2m w
3. Saw cut concrete side path w brick edge – 0.9m w
4. Brick garden edging
5. Site aggregate mulch to planted/tree beds
6. 20mm site aggregate mulch between planted beds
7. Personalisation Opportunity
8. Fragrant borders
9. 3 x Exotic trees – 45L
10. Front boundary edge planting (e.g. Photinia)
11. Letterbox
12. Double gate – 2m width
13. Low retaining wall or edge strip

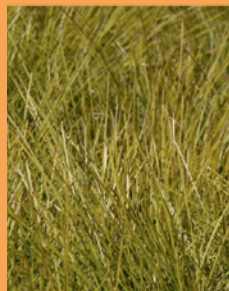

## 6. CONTEMPORARY ARCHITECTURAL GARDEN

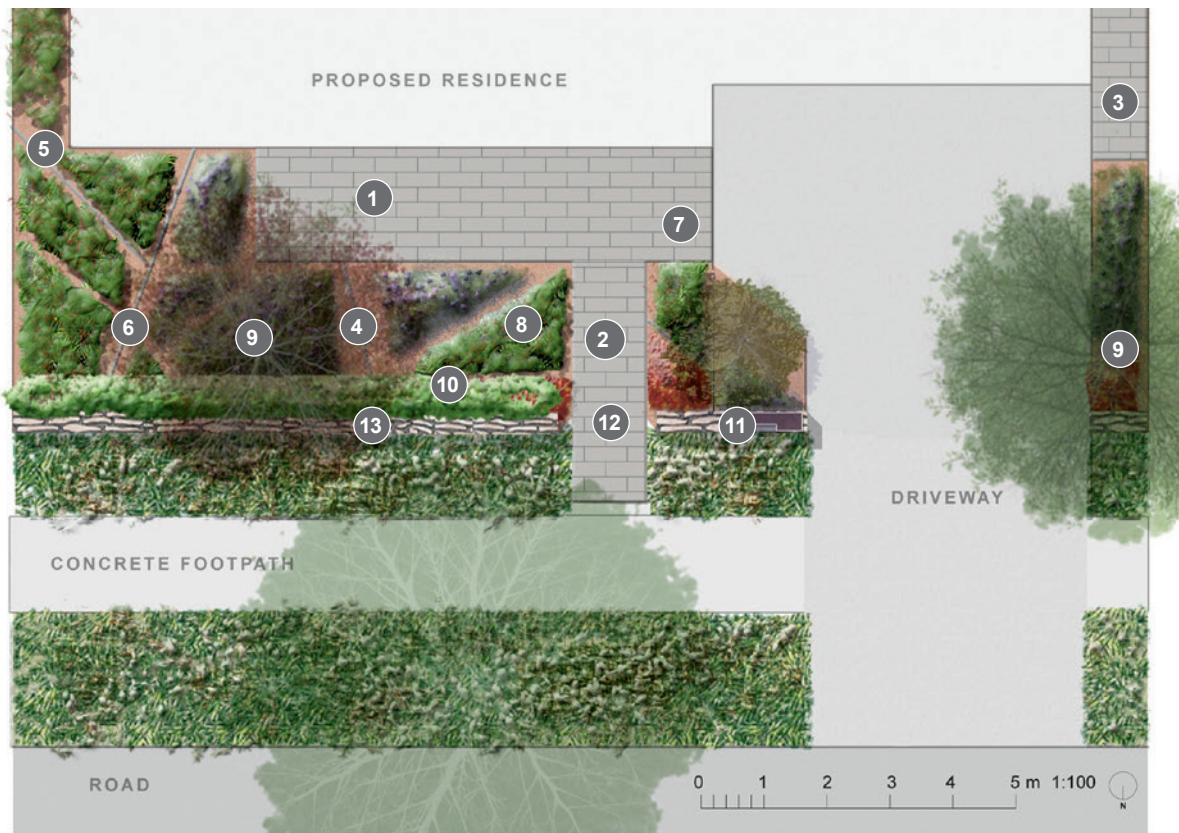

### BOTANICAL NAME

*Acer palmatum* 'Atropurpureum'  
*Magnolia* 'Little Gem'  
*Viburnum tinus*  
*Photinia glabra* 'Rubrum'  
*Sedum* 'Autumn Joy'  
*Echium* (dwarf)  
*Imperata cylindrica* 'Yalba'

### COMMON NAME

Japanese Maple (1)  
 Little Gem Magnolia Tree (1)  
 Laurustinus Viburnum  
 Small Leaf Photinia  
 Autumn Joy Sedum  
 Dwarf Echium  
 Japanese Blood Grass

1. Concrete unit paving veranda recommended – 1.8m w
2. Concrete unit paving front path – 1.2m w
3. Concrete unit paving side path – 0.9m w
4. Recycled steel garden edging
5. Recycled tile mulch to planted beds
6. Recycled tile mulch between planted beds
7. Personalisation Opportunity
8. Bold foliage colour
9. 2 x Exotic trees – 45L
10. Front boundary edge planting (e.g. Viburnum, Photinia)
11. Letterbox
12. Single gate – 1.2m width
13. Low retaining wall or edge strip



## 7. ECOLOGICAL NATIVE GARDEN

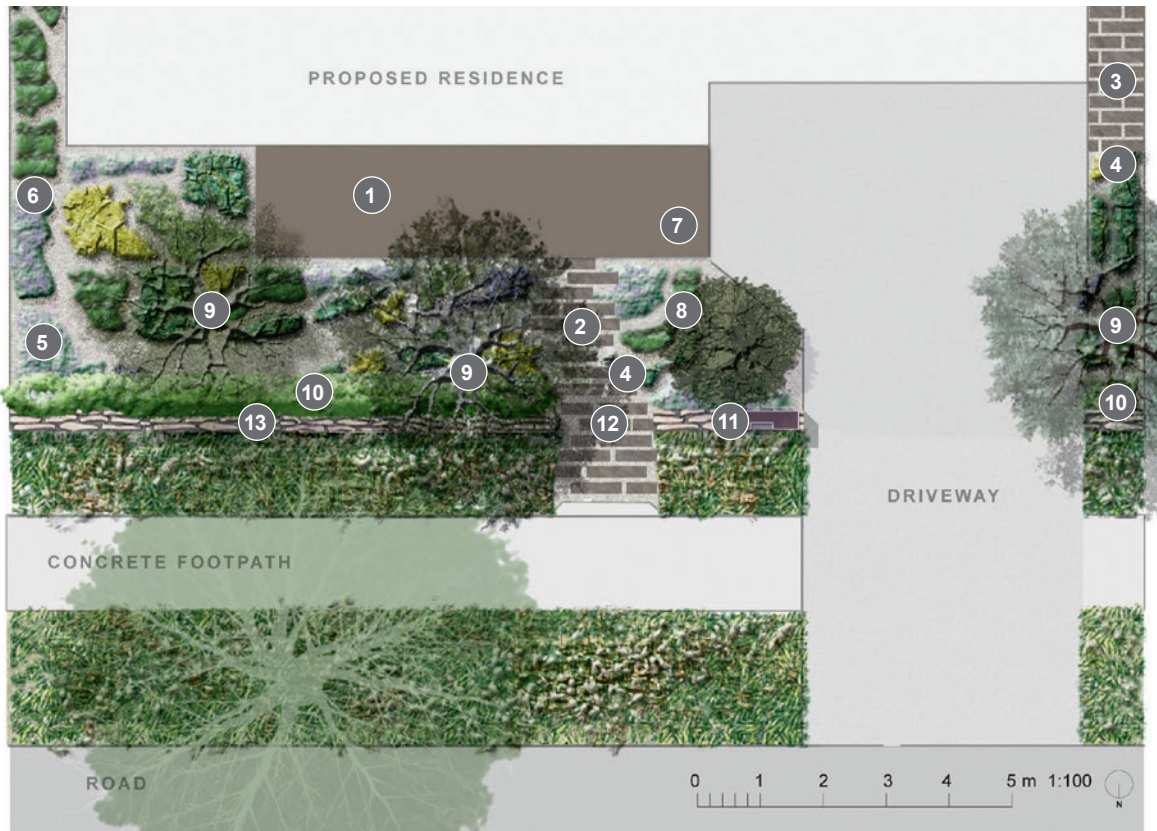

### BOTANICAL NAME

*Eucalyptus cinerea*  
*Eucalyptus paciflora*  
*Eucalyptus kybeanensis*  
*Westringia fruticosa*  
*Viburnum tinus*  
*Dianella revoluta*  
*Poa seiberiana*  
*Stypandra glauca*  
*Brachyscome multifida*  
*Chrysocephalum apiculatum*

### COMMON NAME

Apple Gum Tree (1)  
 Snow Gum Tree (1)  
 Kybran Mallee Tree (1)  
 Coast Rosemary  
 Laurustinus Viburnum  
 Blueberry Flax Lily  
 Grey Tussock Grass  
 Nodding Blue Lily  
 Cut Leaf Daisy  
 Yellow Buttons

1. Stone paving veranda recommended – 1.8m w
2. Stone paving front path – 1.2m w
3. Stone paving side path – 0.9m w
4. No path or garden edging
5. Forest Fines mulch to planted beds
6. Site aggregate mulch between planted beds
7. Personalisation Opportunity
8. Naturalistic planting layout
9. 3 x Native multi-stemmed trees – 75L
10. Front boundary edge planting (e.g. *Westringia*, *Viburnum*)
11. Letterbox
12. Single gate – 1.2m width
13. Low retaining wall or edge strip

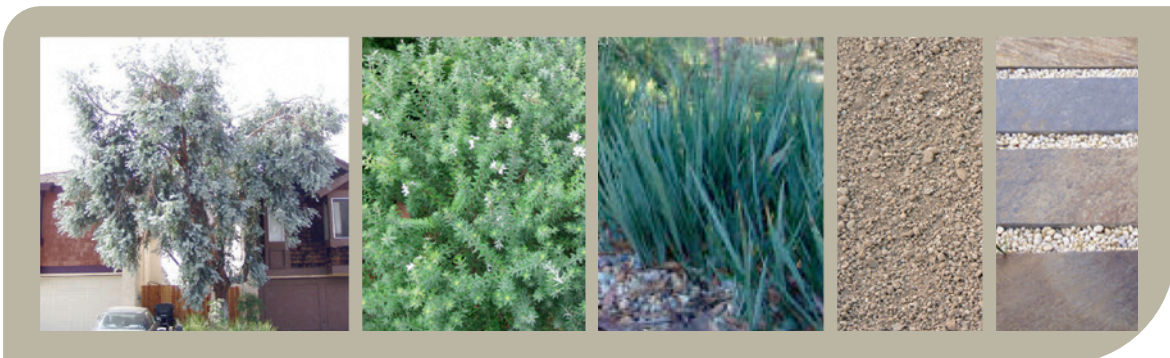

## 8. TRADITIONAL NATIVE GARDEN



### BOTANICAL NAME

*Corymbia ficifolia*

*Hakea laurina*

*Westringia fruticosa*

*Pittosporum sp.*

*Lomandra longifolia*

*Boronia floribunda*

*Ajuga reptans*

### COMMON NAME

Red Flowering Gum Tree (1)

Hakea Tree (1)

Coast Rosemary

Pittosporum

Spiny-head May-rush

Pale Pink Boronia

Blue Bugle

1. Split face stone veranda recommended – 1.8m w
2. Split face stone front path – 1.2m w
3. Split face stone side path – 0.9m w
4. No path or garden edging
5. Forest Fines mulch to planted beds
6. Site aggregate mulch between planted beds
7. Personalisation Opportunity
8. Informal borders of native grasses
9. 3 x Native multi-stemmed trees – 75L (multi-stemmed)
10. Front boundary edge planting (e.g. *Westringia*, *Pittosporum*)
11. Letterbox
12. Double gate –2m width
13. Low retaining wall or edge strip

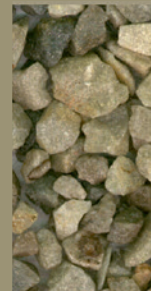

## 9. CONTEMPORARY NATIVE GARDEN

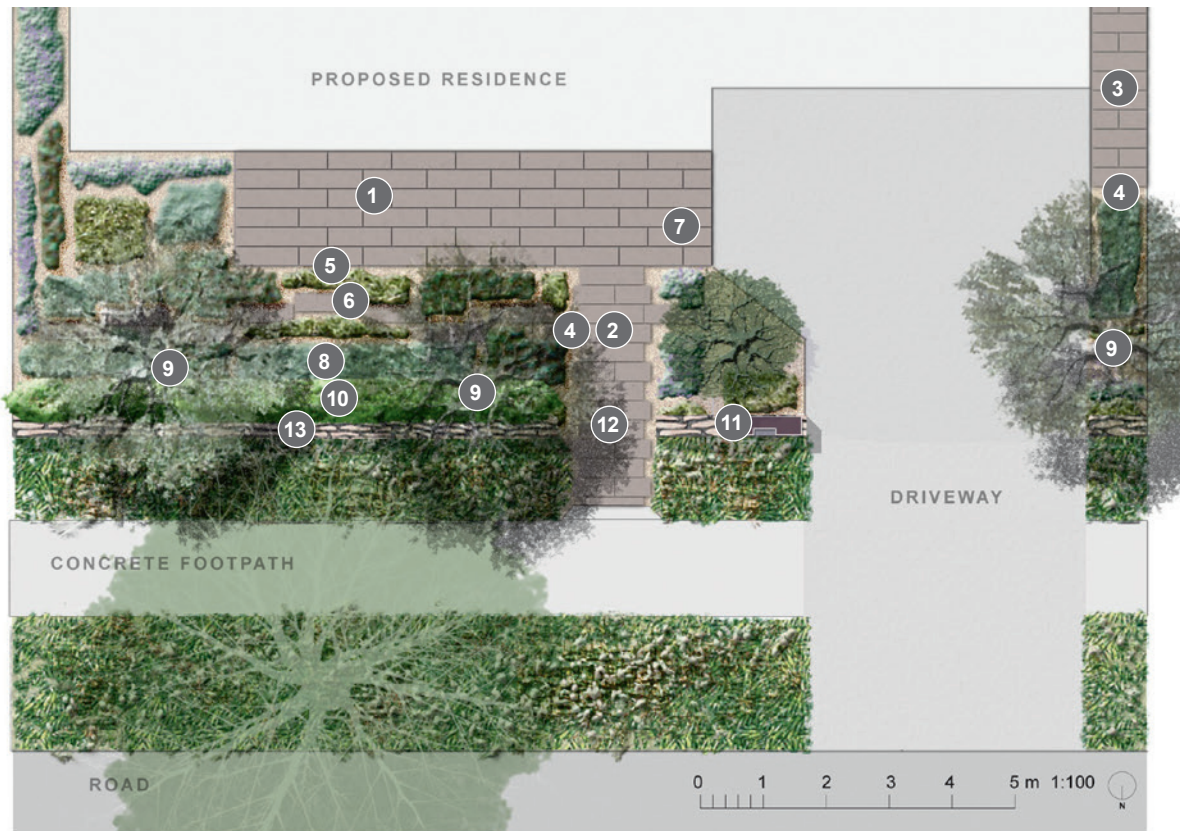

### BOTANICAL NAME

*Eucalyptus paciflora*

*Poa labillardieri*

*Westringia fruticosa*

*Pittosporum* sp.

*Dianella revoluta*

*Banksia* 'Birthday Candles'

### COMMON NAME

Snow Gum Tree (3)

Tussock Grass (1)

Coast Rosemary

Pittosporum

Turf Lily

Birthday Candles Banksia

1. Honed stone veranda recommended – 1.8m w
2. Honed stone front path – 1.2m w
3. Honed stone side path – 0.9m w
4. Recycled steel path and garden edging
5. Forest Fines mulch to planted beds
6. Honed stepping stone between planted beds
7. Personalisation Opportunity
8. Minimalist plant palette
9. 3 x Nxtotic trees – 75L
10. Front boundary edge planting (e.g. *Westringia*, *Pittosporum*)
11. Letterbox
12. Single gate – 1.2m width

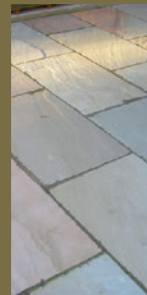

## 10. TREES & PLANTS PALETTE – TREES

Botanical Name	Common Name	Best Used in Type	Mature Plant Size
<i>Malus</i>	Apple Tree	Productive	3.5m x 0.6m
<i>Morus</i>	Mulberry Tree	Productive	10m x 20m
<i>Prunus</i>	Apricot/Cherry/Peach/Plum/ Almond Tree	Productive	4m x 3m
<i>Corylus</i>	Hazelnut Tree	Productive	2-4m x 2m
<i>Olea</i>	Olive Tree	Productive	1-2m x 1-2m
<i>Pyrus</i>	Pear Tree	Productive	8-10m x 7m
<i>Juglans</i>	Walnut Tree	Productive	10m x 20m
<i>Laurus nobilis</i>	Bay Tree	Productive	7m x 3m
<i>Betula</i>	Silver Birch	Architectural/Traditional	8-10m x 3-5m
<i>Malus</i>	Crab Apple	Architectural/Traditional	3-5m x 5-6m
<i>Acer</i>	Maples	Architectural/Traditional	13m x 9m
<i>Lagerstroemia</i>	Crepe Myrtles	Architectural/Traditional	4m x 6m
<i>Pyrus</i>	Ornamental Pear	Architectural/Traditional	8-10 x 7m
<i>Prunus</i>	Ornamental Apricot/Cherry/ Peach/Plum	Architectural/Traditional	2m x 2m
<i>Magnolia grandiflora</i>	Little Gem or Teddy Bear	Architectural/Traditional	4m x 3m
<i>Crataegus</i>	Hawthorn	Architectural/Traditional	5m x 5m
<i>Cornus</i>	Dogwood	Architectural/Traditional	5-10m x 5-10m
<i>Sapium</i>	Chinese Tallow Tree	Architectural/Traditional	5-7m x 3m
<i>Syringa</i>	Lilac Tree	Architectural/Traditional	6m-5m
<i>Eucalyptus leucoxylon</i>	Euky Dwarf	Native	4-10m x 3-4m
<i>Corymbia citriodora</i> 'Dwarf Pink'	Lemon Scented Gum	Native	20m x 8m
<i>Eucalyptus pauciflora gregsoniana</i>	Dwarf Snow Gum	Native	5m x 3m
<i>Eucalyptus scoparia</i>	Wallangarra White Gum	Native	8-12m x 5-10m
<i>Eucalyptus cinerea</i>	Argyle Apple	Native	12m x 7m
<i>Grevillea robusta</i>	Silky Oak	Native	8-20m x 5-14m
<i>Melaleuca irbyana</i>	Weeping Paperbark	Native	10m x 30m

**Disclaimer:** Please note the trees/plants listed above should not be considered an exhaustive list but more suggestive to provide homeowners with the inspiration to select species relative to a particular theme. Given the diverse strains of cultivars and sub species introduced to market every year the tree/plant species above can be varied slightly at the approval of the Googong Compliance Team.



## 10. TREES & PLANTS PALETTE – TREES



Apple Tree



Mulberry Tree



Cherry Tree



Hazelnut Tree



Olive Tree



Pear Tree



Walnut Tree



Bay Tree



Silver Birch

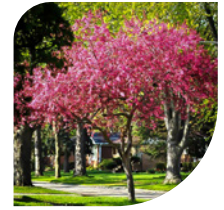

Crab Apple



Maples

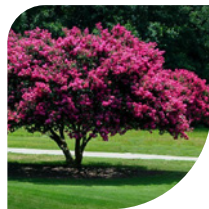

Crepe Myrtles



Ornamental Pear



Ornamental Cherry



Little Gem



Hawthorn



Dogwood



Chinese Tallow

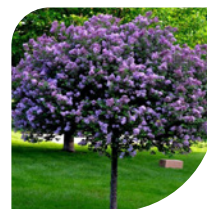

Lilac



Euky Dwarf



Lemon Scented Gum



Dwarf Snow Gum



Wallangarra  
White Gum



Argyle Apple



Silky Oak



Weeping  
Paperbark

## 10. TREES & PLANTS PALETTE – SHRUBS

Botanical Name	Common Name	Best Used in Type	Mature Plant Size
<i>Rosmarinus officinalis</i>	Rosemary	Productive	2m x 1.5m
<i>Vaccinium</i>	Blueberry	Productive	
<i>Origanum vulgare</i>	Oregano	Productive	0.5m x 1m
<i>Lavandula</i>	Lavender	Productive	0.6m x 0.6m
<i>Feijoa coolidge</i>	Feijoa	Productive	3m x 2m
<i>Escallonia</i>	Escallonia	Architectural/Traditional	3m x 2.5m
<i>Rose</i>	Rose	Architectural/Traditional	1.8m x 2.5m
<i>Photinia x Fraseri</i>	Red Fence	Architectural/Traditional	1.5m x 1m
<i>Virbunum</i>	Laurestinus	Architectural/Traditional	3m x 2m
<i>Abelia</i>	Glossy Abelia	Architectural/Traditional	1.5-3m x 3m
<i>Choisya</i>	Mexican Orange Blossom	Architectural/Traditional	2m x 2m
<i>Buddleja</i>	Butterfly Bush	Architectural/Traditional	2m x 2m
<i>Hebe</i>		Architectural/Traditional	0.3-0.9m x 1.2m
<i>Buxus</i>	English, Dutch, Korean Box	Architectural/Traditional	0.3-2m x 0.3-2m
<i>Nandina</i>	Dwarf White Agapanthus	Architectural/Traditional	1.5m x 1.2m
<i>Agapanthus</i>	Lily of the Nile	Architectural/Traditional	1.5m x 1.2m
<i>Cordyline</i>	Cabbage Tree	Architectural/Traditional	1-2m x 0.6m
<i>Protea</i>	Sugarbush	Native	2.5m x 2m
<i>Correa</i>	Native Fuchsia	Native	0.3-1 x 1-2m
<i>Crowea</i>	Waxflower	Native	0.3-3m x 0.3-1.5m
<i>Philotheca</i>	Waxflower	Native	2m x 2m
<i>Pittosporum</i>	Cheesewood	Native	4-5m x 3m
<i>Grevillea</i>	Silky Oak	Native	3m x 3m
<i>Callistemon</i>	Bottle bush	Native	4-5m x 3-4m
<i>Leptospermum</i>	Tea Tree	Native	3m x 1-2m
<i>Leucadendron</i>	Conebush	Native	2.4-3m x 1.8-2.4m
<i>Leucospermum</i>		Native	1.2m x 1.8m
<i>Westringia</i>	Rosemary	Native	2m x 0.8m
<i>Acacia</i>	Wattle	Native	12-15m x 5m
<i>Lomandra 'Tanika'</i>	Breeze Grass	Native	0.6m x 0.7m
<i>Liriope 'Little Giant'</i>	Lilyturf	Native	0.6m x 0.6m
<i>Poa labillardieri 'Eskdale'</i>	Common Tussock Grass	Native	0.6m x 0.5m
<i>Pennisetum sp.</i>	Fountain Grass	Native	1-1.5m x 1m

**Disclaimer:** Please note the trees/plants listed above should not be considered an exhaustive list but more suggestive to provide homeowners with the inspiration to select species relative to a particular theme. Given the diverse strains of cultivars and sub species introduced to market every year the tree/plant species above can be varied slightly at the approval of the Googong Compliance Team.

## 10. TREES & PLANTS PALETTE – SHRUBS



Rosemary



Blueberry



Oregano



Lavender



Feijoa



Escallonia



Rose



Red Fence



Laurestinus



Glossy Abelia



Mexican Orange Blossom



Butterfly Bush



Hebe



English Box



Nandina



Lily of the Nile



Cabbage Tree



Sugarbush



Native Fuchsia



Waxflower



Waxflower



Cheesewood



Silky Oak



Bottle Bush



Tea Tree



Conebush



Leucospermum



Rosemary



Wattle



Breeze Grass



Lilyturf



Common Tussock Grass



Fountain Grass

## 10. TREES & PLANTS PALETTE – GROUND COVERS

Botanical Name	Common Name	Best Used in Garden Type
<i>Salvia officinalis</i>	Sage	Productive
<i>Thymus vulgaris</i>	Thyme	Productive
<i>Symphytum officinale</i>	Comfrey	Productive
<i>Mentha</i>	Mint	Productive
<i>Origanum majorana</i>	Manjoram	Productive
<i>Rosemary lavandulaceus</i>	Creeping Rosemary	Productive
<i>Erigeron karvinskianus</i>	Seaside Daisy	Architectural/Traditional
<i>Trachelospermum jasminoides</i>	Star Jasmine	Architectural/Traditional
<i>Solanum laxum</i>	Potato vine	Architectural/Traditional
<i>Juniperus conferta</i>	Creeping Juniper	Architectural/Traditional
<i>Ajuga reptans</i>	Bugleherb	Architectural/Traditional
<i>Loropetalum Purple Pixie</i>		Architectural/Traditional
<i>Ophiopogon</i>	Mondo Grass	Architectural/Traditional
<i>Festuca glauca</i>	Blue Fescue	Native
<i>Brachyscome multifida</i>	Cut-leafed Daisy	Native
<i>Hardenbergia violacea</i>	Flase Sarsaparilla	Native
<i>Grevillea Royal Mantle</i>		Native
<i>Grevillea Mt Tamboritha</i>		Native
<i>Grevillea Bronze Rambler</i>		Native
<i>Westringia Mundi</i>		Native
<i>Casuarina glauca 'Cousin It'</i>		Native
<i>Helichrysum</i>	Everlasting flowers	Native
<i>Myoporum parvifolium</i>	Creeping Boobialla	Native

**Disclaimer:** Please note the trees/plants listed above should not be considered an exhaustive list but more suggestive to provide homeowners with the inspiration to select species relative to a particular theme. Given the diverse strains of cultivars and sub species introduced to market every year the tree/plant species above can be varied slightly at the approval of the Googong Compliance Team.

## 10. TREES & PLANTS PALETTE – GROUND COVERS



Sage



Thyme



Comfrey



Mint



Manjoram



Creeping  
Rosemary



Seaside Daisy



Star Jasmine



Potato Vine



Creeping  
Juniper



Bugleherb



Loropetalum  
Purple Pixie



Mondo Grass



Blue Fescue



Cut-leafed Daisy



Flase  
Sarsaparilla



Grevillea  
Royal Mantle



Grevillea  
Mt Tamboritha



Grevillea  
Bronze Rambler



Westringia  
Mundi



Casuarina glauca  
'Cousin It'



Everlasting  
Fowers



Creeping  
Boobialla

# COLOURS AND MATERIALS

The following colours and materials are intended to be representative of the palette for Googong. These reflect the natural context of the township. Your colour and material choices can be discussed with the Googong Design Co-ordinator, and are to be approved prior to submitting a development application. Note that some of the examples may be replaced or become discontinued, but the samples provide a guide to what is expected, and other choices that are similar can be used.

## PAINT COLOURS

### DULUX RANGE

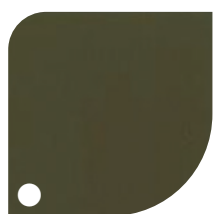

Arrow Shaft



Army Issue

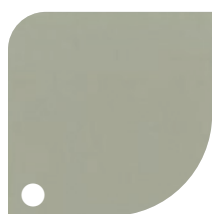

Linseed

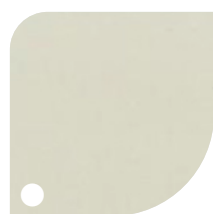

Beige Royal

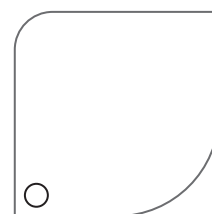

White on White



Jarrah



Self Destruct



Hog Bristle



Ecrú

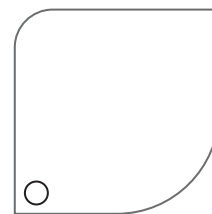

Whisper White



Deep Bamboo



Arava

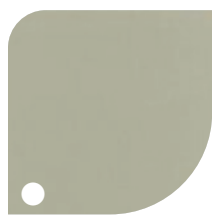

Warm Neutral

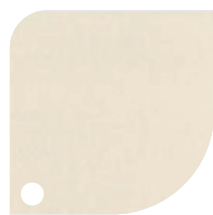

Light Rice

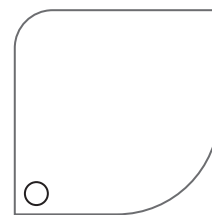

Natural White

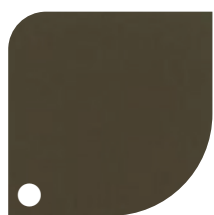

Longford

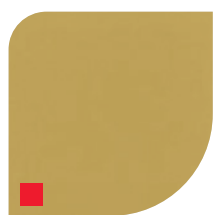

Ginger

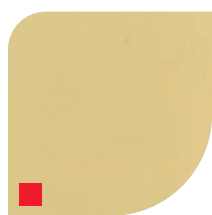

Clay Bake



Jodhpurs

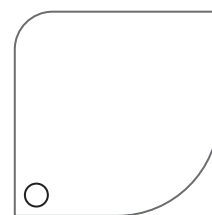

Cottontail

## PAINT COLOURS (CONTINUED)

### EQUAL TO DULUX RANGE



Double Bass



Oboe D'amore



Rameau

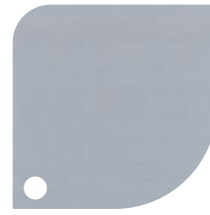

Pommier

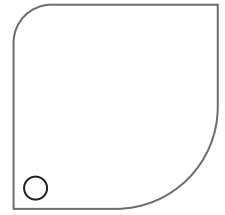

Lexicon



Domino



Ferry

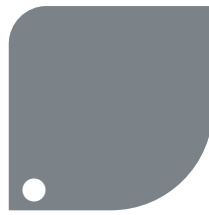

Simone Weil



Oxford

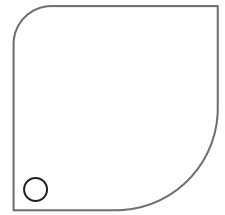

Knowing

### ADDITIONAL DULUX RANGE



Klute

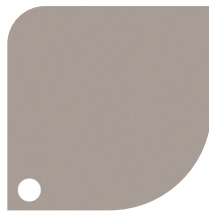

Natural Stone

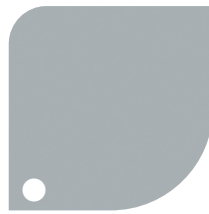

Milton Moon

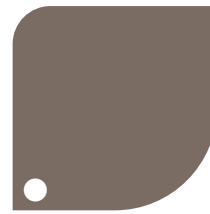

Namabia

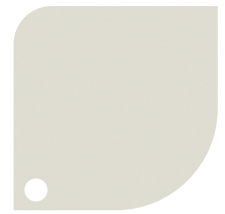

Duck White  
(Quarter Strength)

**NB** Colours shown are approximate only. Printing and scanning limit accuracy. Refer to manufacturers samples.

○ Colour can be used in any location.

■ Colour to be used as accent only (i.e. limited to small areas).

## STONE

Natural stone is a defining feature of the Googong landscape and its incorporation into housing and landscaping elements is encouraged. Use either natural stone, stone cladding or selected masonry blocks in the grey /earth/brown range. Thin strips of stack stone cladding which look artificial and weather poorly should be avoided.

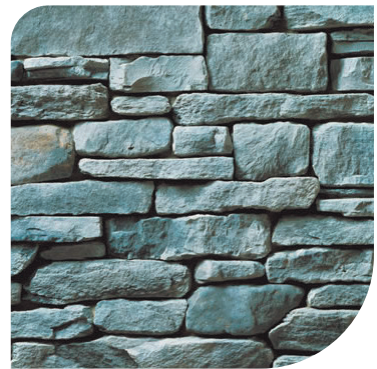



## BRICKS

### PGH BRICKS – ALFRESCO



Chocolatto



Cocoa



Espresso



Truffle



Vino

### PGH BRICKS – ALTITUDE



Apollo



Matterhorn



Olympus

### PGH BRICKS – COMPOSITE



Charcoal



Pebble



Urban Blue

### PGH BRICKS – DARK AND STORMY



Lightning



Monsoon



Thunder



Whirlwind



Zephyr

### PGH BRICKS – DESERT



Gibson



Kalihari



Sahara



Sinai

**NB** Colours shown are approximate only. Printing and scanning limit accuracy. Refer to manufacturers samples.

# BRICKS

## PGH BRICKS – DRY PRESSED ARCHITECTURAL



McGarvie Red



Livingston Gold



Mowbray Blue

## PGH BRICKS – ELEMENTS



Fossil



Graphite



Jarosite



Rubelite

## PGH BRICKS – FOUNDATIONS



Gravel



Pilbara

## PGH BRICKS – METALLIC



Blue Steel Flash



Nickel Flash



Pewter

## PGH BRICKS – MORADA



Gris



Nero

## PGH BRICKS – PURE LINENS



Cinders+Soot



Flannel Grey



Pebble Creek

**NB** Colours shown are approximate only. Printing and scanning limit accuracy. Refer to manufacturers samples.

## BRICKS

### PGH BRICKS – SMOOTH



Black and Tan



Brown



Choc Tan



Copper Glow



Cream



Mineral



Pearl Grey



Red



Terracotta



Volcanic

### PGH BRICKS – VELOUR



Brown



Choc Tan



Cream



Mineral



Pearl Grey



Red



Terracotta



Volcanic

### PGH BRICKS – PALAZZO



Sorbetto

### PGH BRICKS – MANHATTAN

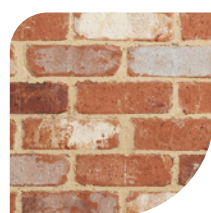

Tribeca

**ACCENT FEATURE WALL APPLICATION ONLY**

Any variation must seek developer approval.

**NB** Colours shown are approximate only. Printing and scanning limit accuracy. Refer to manufacturers samples.

## BRICKS

### AUSTRAL BRICKS – BOWRAL (Certain colours also available in 50mm profile)



Bowral Blue



Bowral Brown



Gert Brown



Murray Grey

### AUSTRAL BRICKS – EVERYDAY LIFE



Engage



Escape



Freedom



Leisure



Stimulate



Unwind

### AUSTRAL BRICKS – HAMPTONS



Whitehaven

**NB** Colours shown are approximate only. Printing and scanning limit accuracy. Refer to manufacturers samples.

## BRICKS

### AUSTRAL BRICKS – METALLIX



Blackstone



Bronze



Platinum



Titanium

### AUSTRAL BRICKS – METROPOLIS



Alabaster



Marcasite



Topaz

### AUSTRAL BRICKS – SCULPTURED SANDS (NATURAL)



Beach



Dolomite



Granite



Magnetite



Ochre



Siltstone



Volcanic

**NB** Colours shown are approximate only. Printing and scanning limit accuracy. Refer to manufacturers samples.

## BRICKS

### AUSTRAL BRICKS – SCULPTURED SANDS (OPAQUE)



Arenite



Calcite



Olivine



Pumice



Quartz



Rockaway

### AUSTRAL BRICKS – URBAN ONE



Chiffon



Latte



Pepper



Praline



Silver

### AUSTRAL BRICKS – WHITSUNDAYS



Brampton



Orpheus

**NB** Colours shown are approximate only. Printing and scanning limit accuracy. Refer to manufacturers samples.

## BRICKS

### AUSTRAL BRICKS – WILDERNESS



Blackberry



Blackbutt



Blue Gum



Grey Gum



Mahogany



Rosewood



Silverbirch

### AUSTRAL BRICKS – SAN SELMO RECLAIMED



Reclaimed Original

#### ACCENT FEATURE WALL APPLICATION ONLY

Any variation must seek developer approval.

**NB** Colours shown are approximate only. Printing and scanning limit accuracy. Refer to manufacturers samples.

## ROOFS – METAL



Evening Haze

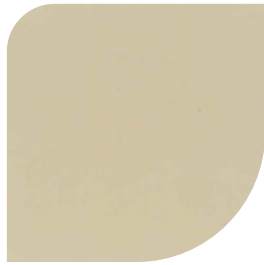

Paperbark



Cove



Shale Grey



Dune



Windspray



Pale Eucalypt



Bushland



Gully



Jasper



Woodland Grey



Ironstone



Wallaby



Basalt



Monument

**NB** Colours shown are approximate only. Printing and scanning limit accuracy. Refer to manufacturers samples. Colours are referenced from the Colorbond® range, and are registered trademarks of BlueScope Steel Limited.



## ROOFS – TILE

### MONIER – HORIZON AND TRADITIONAL SERIES



Horizon Barramundi  
TRADITIONAL



Horizon Aniseed



Horizon Babylon  
PROFILE ONLY



Horizon Camelot  
PROFILE ONLY



Horizon Caraway  
PROFILE ONLY

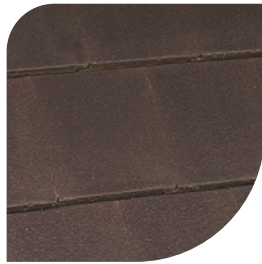

Horizon Fig  
PROFILE ONLY

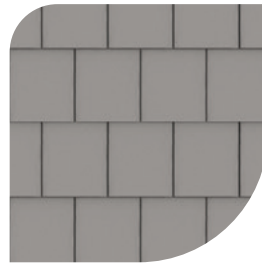

Horizon Wild Rice



Traditional Wild Rice



Traditional Aniseed

## ROOFS – TILE

### BORAL – VOGUE, CONTOUR AND SHINGLES SERIES



Vogue Charcoal Grey



Vogue Dark Chocolate



Vogue Gun Metal

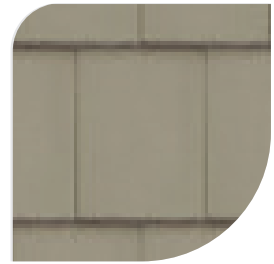

Vogue Savanna



Vogue Walnut

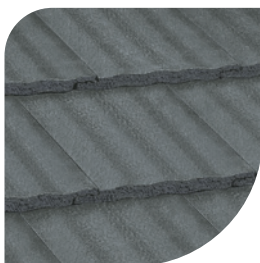

Contour Gunmetal



Contour Walnut



Shingles Savanna



Shingles Asphalt

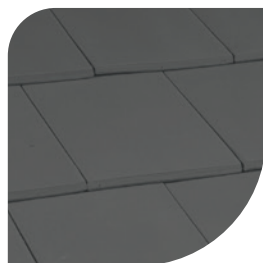

Shingles Gum Ghost Grey

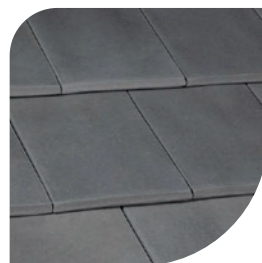

Shingles Scoria

**NB** Colours shown are approximate only. Printing and scanning limit accuracy. Refer to manufacturers samples.

## ROOFS – TILE

### BRISTILE – PRESTIGE AND CLASSIC SERIES



Prestige Pallidium

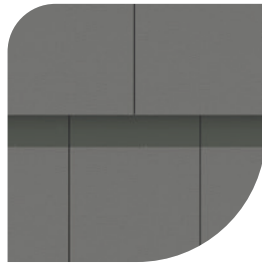

Prestige Titanium

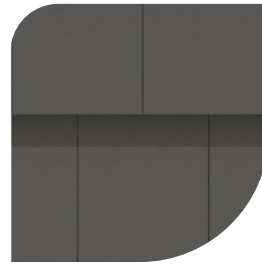

Prestige Tungsten



Prestige Iridium



Prestige Mercury



Classic Mulga



Classic Beach



Classic Birch

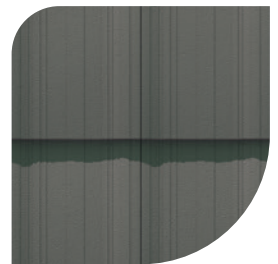

Classic Char Grey

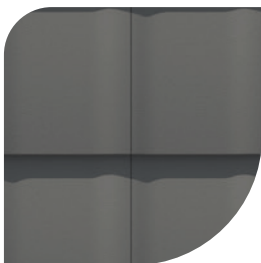

Classic Gunmetal

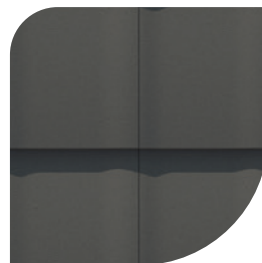

Classic Coal

**NB** Colours shown are approximate only. Printing and scanning limit accuracy. Refer to manufacturers samples.

# GOOGONG CENTRAL DESIGN GUIDELINES





# APPENDICES

## APPENDIX 1 COMPLIANCE CHECKLIST

When submitting your drawings to the Googong Design Co-ordinator for approval, please include a copy of this 'Design Approval Application Form' and 'Design Approval Checklist' and 'External Colours and Materials Schedule'.



**GOOGONG**

### DESIGN APPROVAL APPLICATION FORM

#### LOT DETAILS

Neighbourhood:	Lot Number:
Address:	Stage:

#### PURCHASER DETAILS

Name:		
Address:		
Contact Numbers	Home:	Mobile:
	Business:	
	Email:	

#### BUILDER DETAILS

Name:		
Address:		
Contact Numbers	Business:	Mobile:
	Email:	

#### DESIGNER DETAILS (IF DIFFERENT FROM BUILDER)

Name:		
Address:		
Contact Numbers	Business:	Mobile:
	Email:	

Disclaimer: The Googong design approval process will generally take up to one week from the time a complete application is lodged. Incomplete applications or those requiring amendment will take longer to allow for all details to be submitted and resolved.

Drawings and information requirements to be submitted to Googong Design Co-ordinator for approval prior to submission of a Development Application (DA) or Complying Development Certificate (CDC) Application.

Site plan minimum 1:200 scale showing:

- existing and proposed contours
- proposed floor levels and
- siting of home to meet all DCP housing code setback requirements with dimensions.

Floor plans minimum 1:100 scale showing:

- building area and site coverage (refer to DCP for max site coverage by lot type)
- critical dimensions of frontage of dwelling
- internal layout
- roof plan outline.

Elevations (all) minimum 1:100 scale showing:

- external materials and finishes
- proposed floor levels and building heights (including roof)
- roof pitches and eaves dimensions in accordance with Googong Design Guidelines.

External colours and materials schedule (see over) showing:

- walls
- roof
- external elements (frames, eaves, gutters, downpipes, fascias, shades etc)
- verandah/deck surface.

Landscape plan showing:

- front boundary wall/fence/hedge location, dimensions and details including species and planting sizes
- side boundary return details
- secondary boundary details for corner lots
- front garden landscaping based on Googong Design Guidelines
- driveway details, material and colour
- paving or hardscape
- retaining walls.

Sections showing:

- built form, natural ground level, any construction levels and retaining walls.

BASIX certificates for:

- Water (50% reduction required)
- Energy (40% reduction required)

Checklist of Design Guidelines Requirements – note any rationale for non-compliance below each point.

	✓/X
1. The front boundary has been defined by a low wall/edge strip, fence/hedge and entry pier.	<input type="checkbox"/>
2. Corner lot side boundary has front bounding treatment to 50% of depth, fencing to 1.5m high max and garage to corner street.	<input type="checkbox"/>
3. Front garden based on design palette, and included in building contract.	<input type="checkbox"/>
4. Front verandah 1.8m min, linked by door(s) to house and weather protected.	<input type="checkbox"/>
5. Two rooms to the street, with house planning responding to orientation.	<input type="checkbox"/>
6. Garage 1m min back from main facade, 5.5m min from front boundary, and driveway toned to reduce visual impact.	<input type="checkbox"/>
7. Ground floor height 2.55m-2.70m, max height of building 8.5m, simple roof form, 22.5° min pitch, eaves 450mm min, corner buildings to address both streets.	<input type="checkbox"/>
8. Vertically proportioned openings/frames, visually defined framing, clear entry.	<input type="checkbox"/>
9. Mix of materials to general palette specification.	<input type="checkbox"/>
10. Max cut or fill/retaining walls 1m, stepped building forms on sloping sites.	<input type="checkbox"/>
11. External elements conform to Guidelines.	<input type="checkbox"/>
12. BASIX energy (40% reduction) and water (50% reduction) targets met.	<input type="checkbox"/>















### GOOGONG DESIGN CO-ORDINATOR APPROVAL

Date:















Signed:

Neighbourhood: Googong Central	Lot Number:
Purchaser's Name:	Phone:
Builder's Name:	Phone:







**Metal Roofing (specify location if multiple colours being used)**

<input type="checkbox"/> Evening Haze 	<input type="checkbox"/> Paperbark 	<input type="checkbox"/> Cove 	<input type="checkbox"/> Shale Grey 	<input type="checkbox"/> Dune 	<input type="checkbox"/> Windspray 
<input type="checkbox"/> Pale Eucalypt 	<input type="checkbox"/> Bushland 	<input type="checkbox"/> Gully 	<input type="checkbox"/> Jasper 	<input type="checkbox"/> Woodland Grey 	<input type="checkbox"/> Ironstone 
<input type="checkbox"/> Wallaby 	<input type="checkbox"/> Basalt 	<input type="checkbox"/> Monument 			

**Metal Fascia, Gutter and Down pipes (specify location if multiple colours being used)**

<input type="checkbox"/> Evening Haze 	<input type="checkbox"/> Paperbark 	<input type="checkbox"/> Cove 	<input type="checkbox"/> Shale Grey 	<input type="checkbox"/> Dune 	<input type="checkbox"/> Windspray 
<input type="checkbox"/> Pale Eucalypt 	<input type="checkbox"/> Bushland 	<input type="checkbox"/> Gully 	<input type="checkbox"/> Jasper 	<input type="checkbox"/> Woodland Grey 	<input type="checkbox"/> Ironstone 
<input type="checkbox"/> Wallaby 	<input type="checkbox"/> Basalt 	<input type="checkbox"/> Monument 			











**Tiled Roofing – CSR Monier  Horizon  Traditional (confirm with supplier for individual profile colour range)**

<input type="checkbox"/> Barramundi 	<input type="checkbox"/> Aniseed 	<input type="checkbox"/> Babylon 	<input type="checkbox"/> Camelot 	<input type="checkbox"/> Caraway 	<input type="checkbox"/> Fig 
<input type="checkbox"/> Wild Rice 					

**Tiled Roofing – Boral  Vogue  Contour  Shingles (confirm with supplier for individual profile colour range)**



































<input type="checkbox"/> Charcoal Grey 	<input type="checkbox"/> Dark Chocolate 	<input type="checkbox"/> Gun Metal 	<input type="checkbox"/> Savanna 	<input type="checkbox"/> Walnut 	
--	---	--	--	---	--

**Tiled Roofing – Bristile  Prestige  Classic (confirm with supplier for individual profile colour range)**







































<input type="checkbox"/> Pallidium 	<input type="checkbox"/> Titanium 	<input type="checkbox"/> Tungsten 	<input type="checkbox"/> Iridium 	<input type="checkbox"/> Mercury 	
<input type="checkbox"/> Mulga 	<input type="checkbox"/> Beach 	<input type="checkbox"/> Birch 	<input type="checkbox"/> Char Grey 	<input type="checkbox"/> Gunmetal 	<input type="checkbox"/> Coal 

























**External Wall colours**

**Indicate Base (B) and Accent (A) and location of Accents colours** \* accent colours only  
 Note all colours are Dulux colours – Equivalent colours from other manufacturers can be submitted with appropriate colour samples and descriptions

<input type="checkbox"/> Arrow Shaft 	<input type="checkbox"/> Army Issue 	<input type="checkbox"/> Linseed 	<input type="checkbox"/> Beige Royal 	<input type="checkbox"/> Double Bass 	<input type="checkbox"/> White on White 
<input type="checkbox"/> Jarrah 	<input type="checkbox"/> Self Destruct 	<input type="checkbox"/> Hog Bristle 	<input type="checkbox"/> Ecu 	<input type="checkbox"/> Oboe D'amore 	<input type="checkbox"/> Whisper White 
<input type="checkbox"/> Deep Bamboo 	<input type="checkbox"/> Arava 	<input type="checkbox"/> Warm Neutral 	<input type="checkbox"/> Light Rice 	<input type="checkbox"/> Rameau 	<input type="checkbox"/> Natural White 
<input type="checkbox"/> Longford 	<input type="checkbox"/> Ginger* 	<input type="checkbox"/> Clay Bake* 	<input type="checkbox"/> Jodhpurs 	<input type="checkbox"/> Pommier 	<input type="checkbox"/> Lexicon 
<input type="checkbox"/> Domino* 	<input type="checkbox"/> Ferry* 	<input type="checkbox"/> Simone Weil 	<input type="checkbox"/> Oxford 	<input type="checkbox"/> Cottontail 	<input type="checkbox"/> Knowing 
<input type="checkbox"/> Klute 	<input type="checkbox"/> Natural Stone 	<input type="checkbox"/> Milton Moon 	<input type="checkbox"/> Namabia 	<input type="checkbox"/> Duck White 1/4 Strength 	<input type="checkbox"/> Other _____























Bricks - PGH									
	<input type="checkbox"/> Smooth Face	<input type="checkbox"/> Velour	<input type="checkbox"/> 50mm						
<b>Alfresco</b>	<input type="checkbox"/> Choccolato 	<input type="checkbox"/> Cocoa 	<input type="checkbox"/> Espresso 	<input type="checkbox"/> Truffle 	<input type="checkbox"/> Vino 				
<b>Altitude</b>	<input type="checkbox"/> Apollo 	<input type="checkbox"/> Matterhorn 	<input type="checkbox"/> Olympus 						
<b>Composite</b>	<input type="checkbox"/> Charcoal 	<input type="checkbox"/> Pebble 	<input type="checkbox"/> Urban Blue 						
<b>Dark and Stormy</b>	<input type="checkbox"/> Lightning 	<input type="checkbox"/> Monsoon 	<input type="checkbox"/> Thunder 	<input type="checkbox"/> Whirlwind 	<input type="checkbox"/> Zephyr 				
<b>Desert</b>	<input type="checkbox"/> Gibson 	<input type="checkbox"/> Kalihari 	<input type="checkbox"/> Sahara 	<input type="checkbox"/> Sinai 					
<b>Dry Pressed Architectural</b>	<input type="checkbox"/> McGarvie Red 	<input type="checkbox"/> Livingston Gold 	<input type="checkbox"/> Mowbray Blue 						
<b>Elements</b>	<input type="checkbox"/> Fossil 	<input type="checkbox"/> Graphite 	<input type="checkbox"/> Jarosite 	<input type="checkbox"/> Rubelite 					
<b>Foundations</b>	<input type="checkbox"/> Gravel 	<input type="checkbox"/> Pilbara 							
<b>Modra</b>	<input type="checkbox"/> Gris 	<input type="checkbox"/> Nero 							
<b>Metallic</b>	<input type="checkbox"/> Blue Steel Flash 	<input type="checkbox"/> Nickel Flash 	<input type="checkbox"/> Pewter 						
<b>Pure Linens</b>	<input type="checkbox"/> Cinders+Soot 	<input type="checkbox"/> Flannel Grey 	<input type="checkbox"/> Pebble Creek 						
<b>Smooth</b>	<input type="checkbox"/> Black and Tan 	<input type="checkbox"/> Brown 	<input type="checkbox"/> Choc Tan 	<input type="checkbox"/> Copper Glow 	<input type="checkbox"/> Cream 				
	<input type="checkbox"/> Mineral 	<input type="checkbox"/> Pearl Grey 	<input type="checkbox"/> Red 	<input type="checkbox"/> Terracotta 	<input type="checkbox"/> Volcanic 				
<b>Velour</b>	<input type="checkbox"/> Brown 	<input type="checkbox"/> Choc Tan 	<input type="checkbox"/> Cream 	<input type="checkbox"/> Mineral 	<input type="checkbox"/> Pearl Grey 				
	<input type="checkbox"/> Red 	<input type="checkbox"/> Terracotta 	<input type="checkbox"/> Volcanic 						
<b>Palazzo</b>	<input type="checkbox"/> Sorbetto 								
<b>Manhattan</b>	<input type="checkbox"/> Tribeca 	<b>FEATURE WALL APPLICATION ONLY</b> Any variation must seek developer approval.							











Bricks - Austral									
<b>Bowral (<input type="checkbox"/> 50mm)</b>	<input type="checkbox"/> Bowral Blue 	<input type="checkbox"/> Bowral Brown 	<input type="checkbox"/> Gert Brown 	<input type="checkbox"/> Murray Grey 					
<b>Everyday Life</b>	<input type="checkbox"/> Engage 	<input type="checkbox"/> Escape 	<input type="checkbox"/> Freedom 	<input type="checkbox"/> Leisure 	<input type="checkbox"/> Stimulate 				
	<input type="checkbox"/> Unwind 								
<b>Hamptons</b>	<input type="checkbox"/> Whitehaven 								
<b>Metallix</b>	<input type="checkbox"/> Blackstone 	<input type="checkbox"/> Keswick 	<input type="checkbox"/> Platinum 	<input type="checkbox"/> Titanium 					
<b>Metropolis</b>	<input type="checkbox"/> Alabaster 	<input type="checkbox"/> Marcasite 	<input type="checkbox"/> Topaz 						
<b>Sculptured Sands (Natural)</b>	<input type="checkbox"/> Beach 	<input type="checkbox"/> Dolomite 	<input type="checkbox"/> Granite 	<input type="checkbox"/> Magnetite 	<input type="checkbox"/> Ochre 				
	<input type="checkbox"/> Siltstone 	<input type="checkbox"/> Volcanic 							

Bricks continued overleaf.











**Bricks - Austral (Continued)**

<b>Sculptured Sands (Opaque)</b>	<input type="checkbox"/> Arenite		<input type="checkbox"/> Calcite		<input type="checkbox"/> Olivine		<input type="checkbox"/> Pumice		<input type="checkbox"/> Quartz	
	<input type="checkbox"/> Rockaway									
<b>Urban One</b>	<input type="checkbox"/> Chiffon		<input type="checkbox"/> Latte		<input type="checkbox"/> Pepper		<input type="checkbox"/> Praline		<input type="checkbox"/> Silver	
<b>Whitsundays</b>	<input type="checkbox"/> Brampton		<input type="checkbox"/> Orpheus							
<b>Wilderness</b>	<input type="checkbox"/> Blackberry		<input type="checkbox"/> Blackbutt		<input type="checkbox"/> Blue Gum		<input type="checkbox"/> Grey Gum		<input type="checkbox"/> Mahogany	
	<input type="checkbox"/> Rosewood		<input type="checkbox"/> Silverbirch							
<b>San Selmo Reclaimed</b>	<input type="checkbox"/> Reclaimed Original		<b>FEATURE WALL APPLICATION ONLY</b> Any variation must seek developer approval.							



**Window and Door Frames**

<input type="checkbox"/> Bushland		<input type="checkbox"/> Woodland Gray		<input type="checkbox"/> Jasper		<input type="checkbox"/> Shale Gray		<input type="checkbox"/> Evening Haze		<input type="checkbox"/> Ironstone	
<input type="checkbox"/> Dune		<input type="checkbox"/> Windspray		<input type="checkbox"/> Paperbark		<input type="checkbox"/> Surfmist		<input type="checkbox"/> Monument		<input type="checkbox"/> Timber	

**Front Door**

<input type="checkbox"/> Bushland		<input type="checkbox"/> Woodland Gray		<input type="checkbox"/> Jasper		<input type="checkbox"/> Shale Gray		<input type="checkbox"/> Evening Haze		<input type="checkbox"/> Ironstone	
<input type="checkbox"/> Dune		<input type="checkbox"/> Windspray		<input type="checkbox"/> Paperbark		<input type="checkbox"/> Surfmist		<input type="checkbox"/> Monument		<input type="checkbox"/> Timber	

**Garage Door**

<input type="checkbox"/> Bushland		<input type="checkbox"/> Woodland Gray		<input type="checkbox"/> Jasper		<input type="checkbox"/> Shale Gray		<input type="checkbox"/> Evening Haze		<input type="checkbox"/> Ironstone	
<input type="checkbox"/> Dune		<input type="checkbox"/> Windspray		<input type="checkbox"/> Paperbark		<input type="checkbox"/> Pale Eucalypt		<input type="checkbox"/> Sandbank		<input type="checkbox"/> Wilderness	
<input type="checkbox"/> Monument		<input type="checkbox"/> Timber									

**Additional colour and finish information**

Driveway and crossings finish and colour:

Plain

Oxide \_\_\_\_%

Retaining wall material and colour:

Front boundary wall/strip material and colour:

Additional materials or colours. Please attach sample(s):

## APPENDIX 2 GUILD BUILDERS AND PARTNER BUILDERS

### GUILD BUILDERS

---

#### **Achieve Homes**

Phone: 1300 234 432  
Email: sales@achievehomes.com.au  
achievehomes.com.au

#### **APA Homes**

Phone: 02 6299 9400  
Email: sales@apahomes.com.au  
apahomes.com.au

#### **BLD Homes**

Phone: 02 6280 4190  
Email: admin@bldhomes.com.au  
bldhomes.com.au

#### **Burbank**

Phone: 13 BURBANK (2872265)  
Email: NSW.Enquiries@burbank.com.au  
burbank.com.au

#### **DJ Homes**

Phone: 02 6297 1017  
Email: grant@djhomes.com.au  
djhomes.com.au

#### **Exceed Homes**

Phone: 0402 222 062  
Email: info@exceedhomes.com.au  
exceedhomes.com.au

#### **GJ Gardner Homes Fyshwick**

Phone: 02 6162 1690  
Email: david.norman@gjgardner.com.au  
gjgardner.com.au

#### **Ideal Building Solutions**

Phone: 02 6236 9186  
Email: info@idealbuildingsolutions.com.au  
idealbuildingsolutions.com.au

#### **JD Homes**

Phone: 0411 473 170  
Email: info@jdhomes.net.au  
jdhomes.net.au

#### **McDonald Jones Homes (Canberra)**

Phone: 02 6143 2080  
Email: sales.canberra@mcdonaldjones.com.au  
mcdonaldjoneshomes.com.au

#### **Rawson Homes**

Phone: 1300 223 345  
Email: sales@rawson.com.au  
rawsonhomes.com.au

#### **Thrive Homes**

Phone: 1300 921 383  
Email: hello@thrivehomes.com.au  
thrivehomes.com.au

#### **Vogue Constructions**

Phone: 02 6242 0030  
Email: sales@vogueconstructions.com.au  
vogueconstructions.com.au

### PARTNER BUILDERS

---

#### **BBS Homes**

Phone: 1300 897 179  
Email: sales@bbshomes.com.au  
bbshomes.com.au

#### **Dixon Homes**

Phone: 1300 101 010  
Email: sales@dixonhomesact.com.au  
dixonhomes.com.au







**For further details contact:**

The Googong Design Co-ordinator • Googong Township Pty Ltd  
64 Allara Street Canberra City  
Phone: 02 6230 0800 • Email: [enquiries@googong.net](mailto:enquiries@googong.net)

[googong.net](http://googong.net)

