

Instrument PS732577J – Building Envelope Document

Any building on lots 101 to 108, 115 to 137 and 140 to 150 (all inclusive) within subdivision plan PS732577J must be contained within the building envelopes shown on the plan and defined by the associated setback profiles and written notes contained herein. The building envelopes are part of planning permit WYP 6864/13, issued by Wyndham City Council on 18th November 2014, being created as a condition of that permit.

1 TEXT OF RESTRICTIONS

The matters which are restricted by the building envelopes are:

1.1 Minimum street setback

Buildings on the lot must be set back from the main street frontage by the minimum distance noted on the plan, or if no front setback dimension is shown on the plan, at least 4 metres from the main street frontage.

Garages / Carports are to be setback a minimum of 5 metres from the main street frontage and at least 0.50 metres behind the front façade of the dwelling.

In the case of corner lots, buildings must be setback a minimum of 2 metres from the secondary frontage or, if applicable, the minimum distance noted on plan.

Encroachments:

The following may encroach into the setback distance required above by not more than 1.5m

- a. Verandahs and porches that have a maximum height of not more than 3.6m metres above the natural ground
- b. Unroofed balconies that have a maximum height of not more than 4.0 metres above the natural ground
- c. Eaves, fascia and gutters
- d. Screens referred to in regulations 419(5) (d) or 419(5) of the Building Regulations 2006
- e. Decks, steps or landings - less than 800 mm in height

1.2 Building height

The height of a building must not exceed the maximum building height shown in setback profiles. Heights are measured vertically from natural ground level.

1.3 Site coverage

Regardless of the extent of the building envelope, buildings must not occupy more than 60 per cent of the lot. In calculating site coverage, eaves, fascia and gutters not exceeding 600mm in total width, and unroofed swimming pools, terraces, patios, decks and pergolas may be disregarded.

1.4 Side and rear setbacks

Side setbacks

A building on the lot must be set back from a side boundary not less than the distances specified in setback profiles described in this document or the distance specified in a side setback dimension written on the plan.

Rear setbacks

Rear setbacks apply to any wall of a building where the wall is not facing the front or side boundary of the lot.

A rear wall of a building exceeding 3.6 metres in height must be set back from the rear boundary by not less than the distance shown on the plan.

Encroachments

The following may encroach into the specified side and rear setback distances by not more than 500mm:

- Porches and verandahs
- Masonry chimneys
- Sunblinds
- Flues and pipes
- Domestic fuel tanks and water tanks
- Heating and cooling equipment and other services.

The following may encroach into the specified setback distances:

- Landings with an area of not more than 2 square metres and less than 1 metre high
- Unroofed stairways and ramps
- Pergolas
- Shade sails
- Eaves, fascia, gutters not more than 600mm in total width

Side and rear setbacks from boundaries that are shared with lots, which are not beneficiaries of this restriction, are not dealt with by this building envelope except where annotated on plan.

1.5 Walls on boundaries

Walls less than 1m from the boundary must be within 200mm of the boundary and be contained within the side and rear setbacks permitted by the building envelope.

Walls on boundaries are to comply with the following:

- Restricted to a total length of 10m plus 25% of the remaining length of the boundary.
- Maximum height of a wall is restricted to 3.6m

1.6 Daylight to existing habitable room windows

A building must be set back from a habitable room window in an existing building on an adjoining lot to provide for a light court to the existing window that has a minimum area of 3 square metres and a minimum dimension of 1m clear to the sky. The area of the light court may include land on the adjoining lot.

A wall or carport with an average height of more than 3.6 metres opposite a habitable room window in an existing dwelling on an adjoining lot must be setback from the window at least half the height of the wall or carport if the wall or carport is within a 55 degree angle in the horizontal plane about a vertical axis through the centre of the window. The angle may be swung to not less than 35 degrees from the plan of the wall containing the window.

This is illustrated in the two diagrams below.

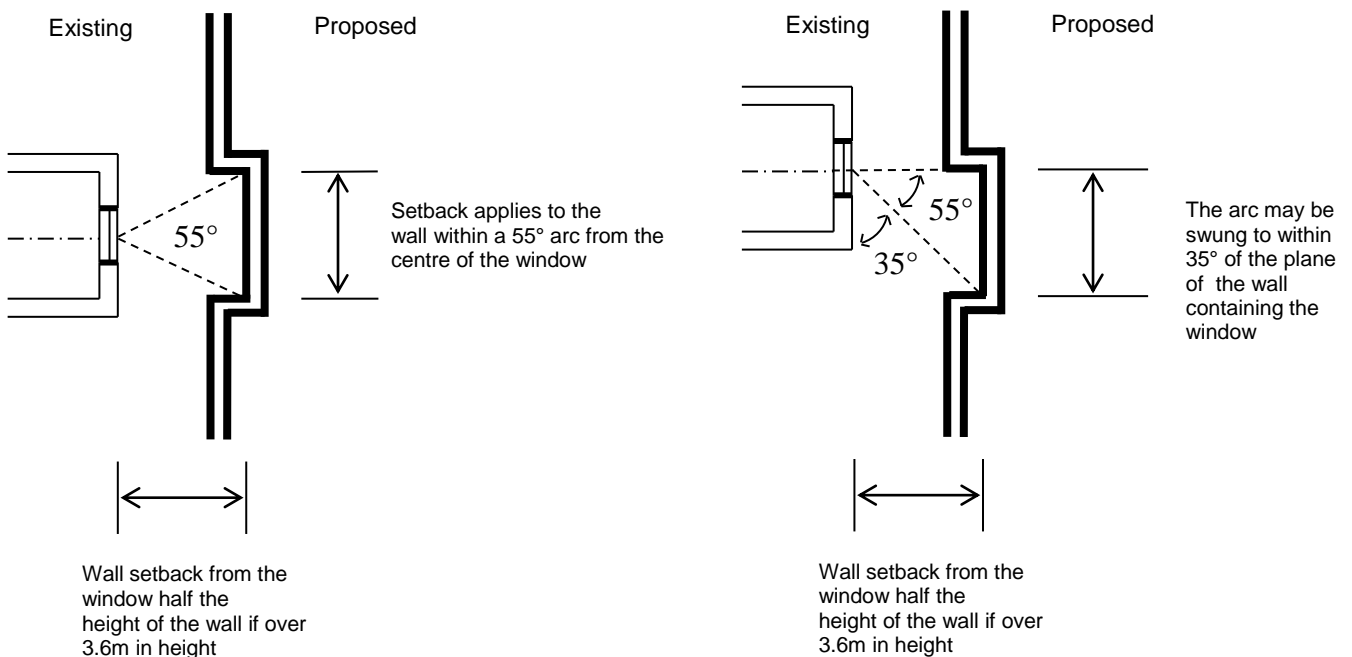

If the existing habitable room window is above ground level, the wall or carport height is measured from the floor level of the room containing the window.

Daylight to habitable room windows in buildings on lots, which are not beneficiaries of this restriction, is not dealt with by this building envelope except where annotated on plan.

1.7 Overshadowing of recreational private open space

Refer to Building Regulations 2006 for Overshadowing requirements

1.8 Overlooking

Refer to Building Regulations 2006 for Overlooking requirements.

Views from Habitable room windows, decks or raised open spaces.

- If a habitable room window, deck or raised open space is within an overlooking zone in a setback profile or indicated on the plan, and has a floor level of 800mm or greater above natural ground level, it must be screened to 1.7 metres above the floor level. In the case of a rear boundary then the above rule applies within 5.5 metres of the boundary.

Screening a view.

- A view can be screened by the use of fencing, obscure glazing and other screening devices approved as per the building regulations.

2.0 Notes on the Restrictions:

1. Ground level after engineering works associated with subdivision is to be regarded as natural ground level,
2. In the case of conflict between the plan or profile diagrams and these written notations, the specifications in the plan or profile diagrams prevail,
3. Buildings must not cover registered easements unless provided for by the easement.

3.0 General Definitions

If not defined above, the words below shall have the meaning attributed to them in the document identified:

In the *Building Act 1993*:

- Building

In Parts 1 and 4 of *Building Regulations 2006*:

- Clear to the sky
- Height
- Private open space
- Recreational private open space
- Raised open space
- Secluded private open space
- Setback
- Site coverage
- Allotment
- Single dwelling
- North (true north)

In the *Victoria Planning Provisions, 31 October 2002*:

- Frontage (Clause 72)
- Dwelling (Clause 74)
- Habitable room (Clause 72)
- Storey (Clause 72)

Additional definitions

Front street or Main Street frontage

The street frontage that allows the most direct access to the front door.

Side boundary

A boundary of a lot that runs between and connects the street frontage of the lot to the rear boundary the lot.

Street

For the purposes of determining street setbacks, street means any road other than a laneway, footway, ally or right of way.

Standard lot

A single lot that accommodates a freestanding house detached from adjoining houses and of an individual style. A standard lot can also include provision for single storey non-common boundary walls and which do not have to be in contact with an adjoining structure.

Terrace lot



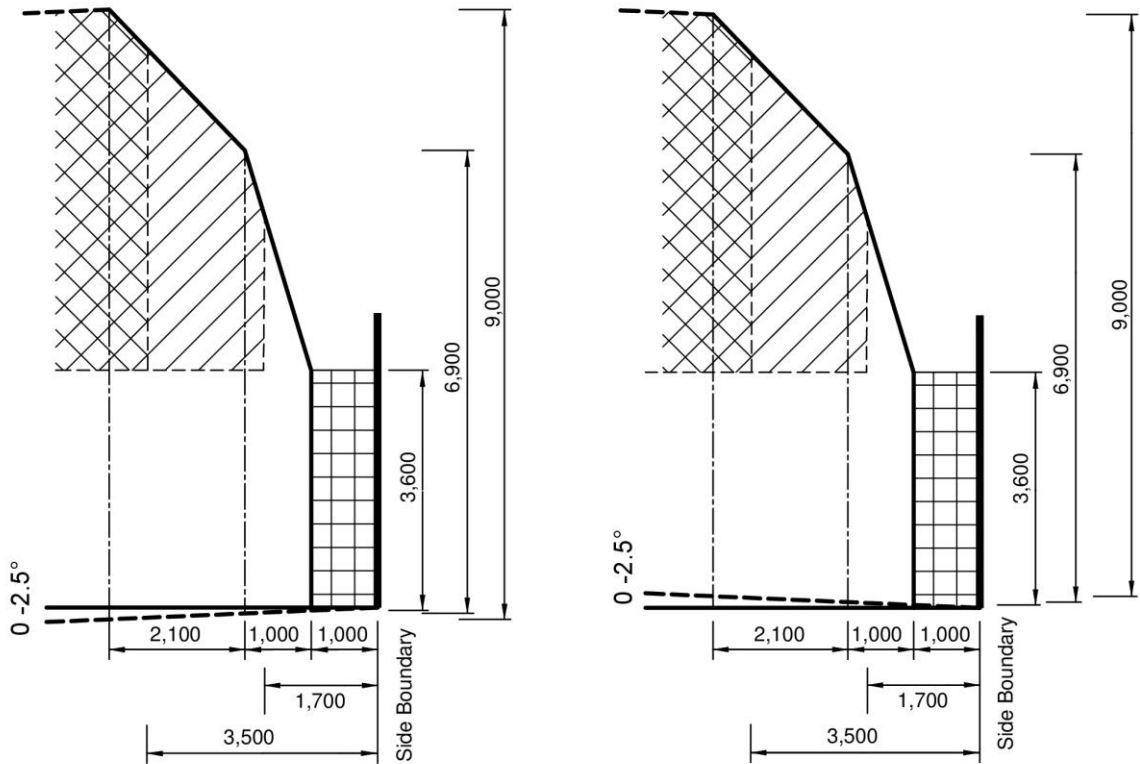

One of a row of 2 or more lots where the houses are attached, generally 2 storeys in height and of a uniform style. The terrace houses are built to the side boundaries on the individual allotments and are joined together with two-story common walls or abutting boundary walls.

0 - 2.5° Slope
STANDARD ALLOTMENT:

A1



NORTH, EAST or WEST Boundary



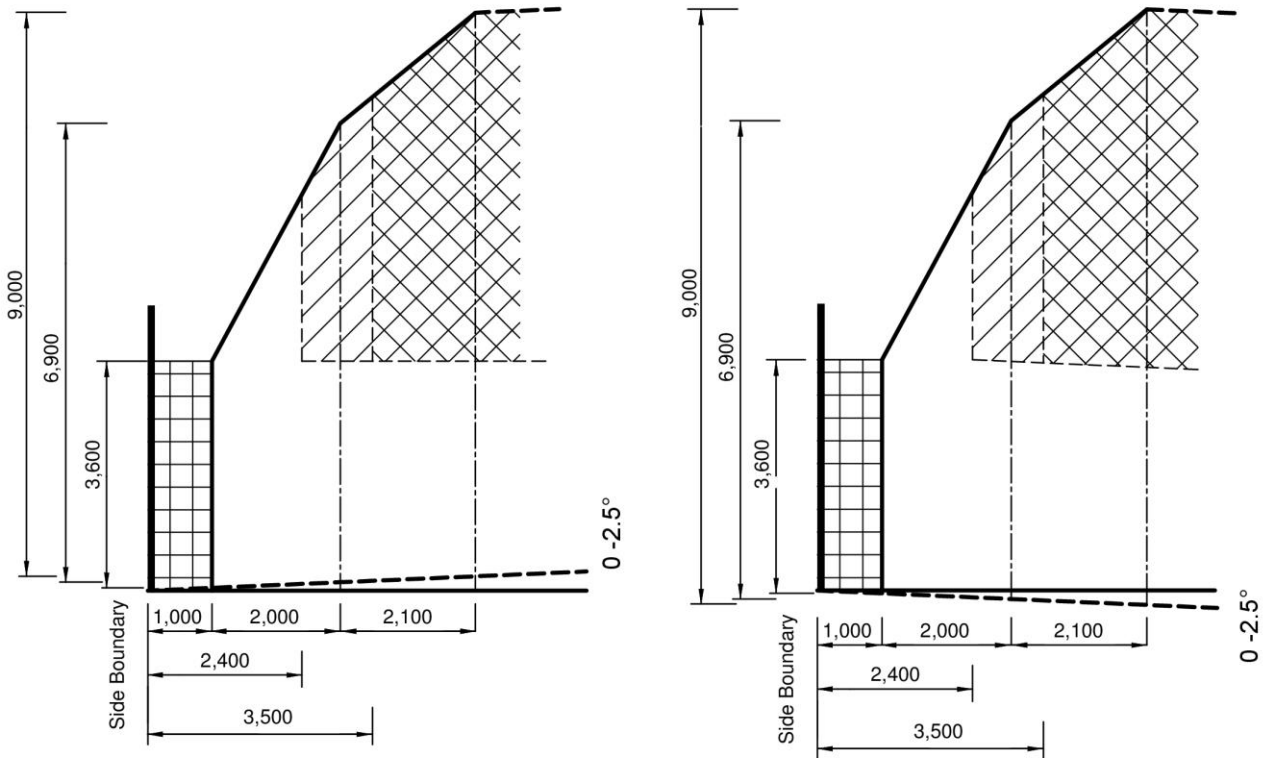

-  Single Storey Building Envelope
-  Overlooking Zone
Habitable room windows/Raised open spaces are a source of overlooking.
-  Non Overlooking Zone
Habitable room windows/Raised open spaces are not a source of overlooking.
-  Building to Boundary Zone

0 - 2.5° Slope
STANDARD ALLOTMENT:

B1



South Boundary



-  Single Storey Building Envelope
-  Overlooking Zone
Habitable room windows/Raised open spaces are a source of overlooking.
-  Non Overlooking Zone
Habitable room windows/Raised open spaces are not a source of overlooking.
-  Building to Boundary Zone

0 - 2.5° Slope
STANDARD ALLOTMENT:

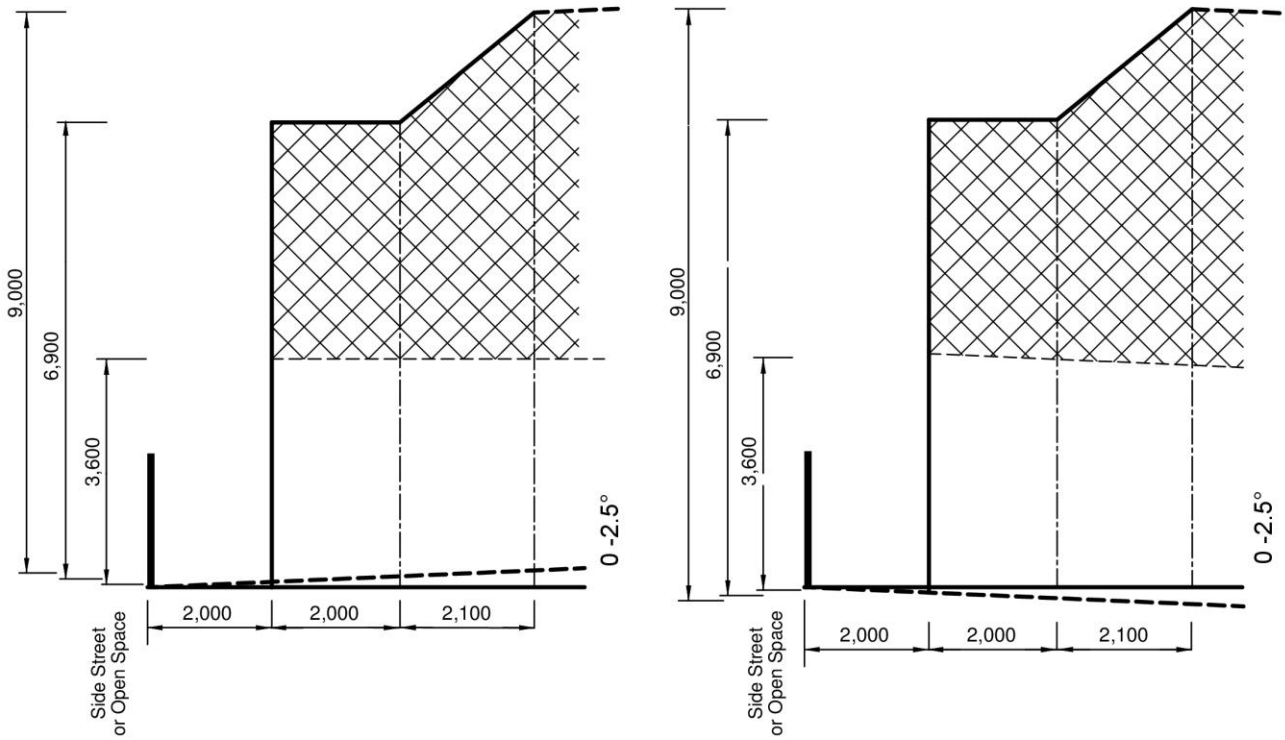
S1

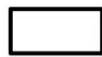

Side boundary abuts street
or public open space

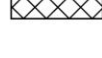

-  Single Storey Building Envelope
-  Overlooking Zone
Habitable room windows/Raised open spaces are a source of overlooking.
-  Non Overlooking Zone
Habitable room windows/Raised open spaces are not a source of overlooking.
-  Building to Boundary Zone

0 - 2.5° Slope
STANDARD ALLOTMENT:

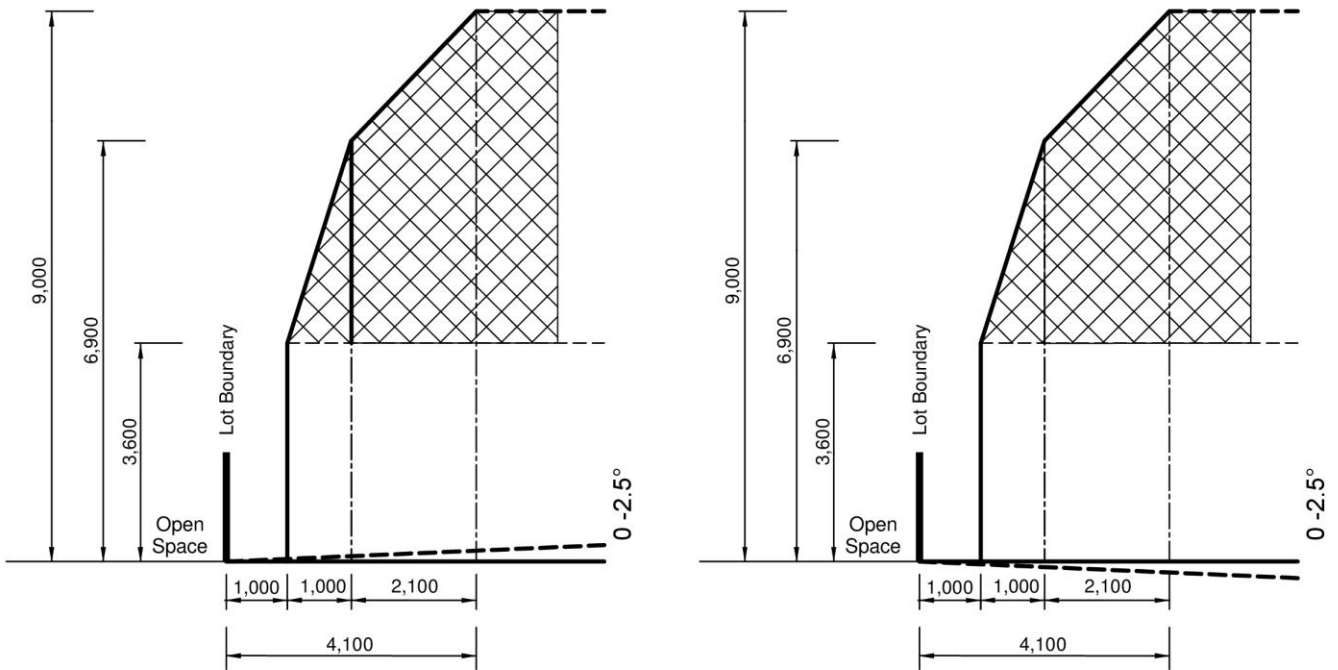
S2



Side boundary abuts Reserve

-  Single Storey Building Envelope
-  Double Storey Building Envelope

LEGEND

Building Envelope

Double Storey Zone

★
Lots defined as Type A Lots under
Small Lot Housing Code

Refer to Restriction No. 2 in PS 732577J

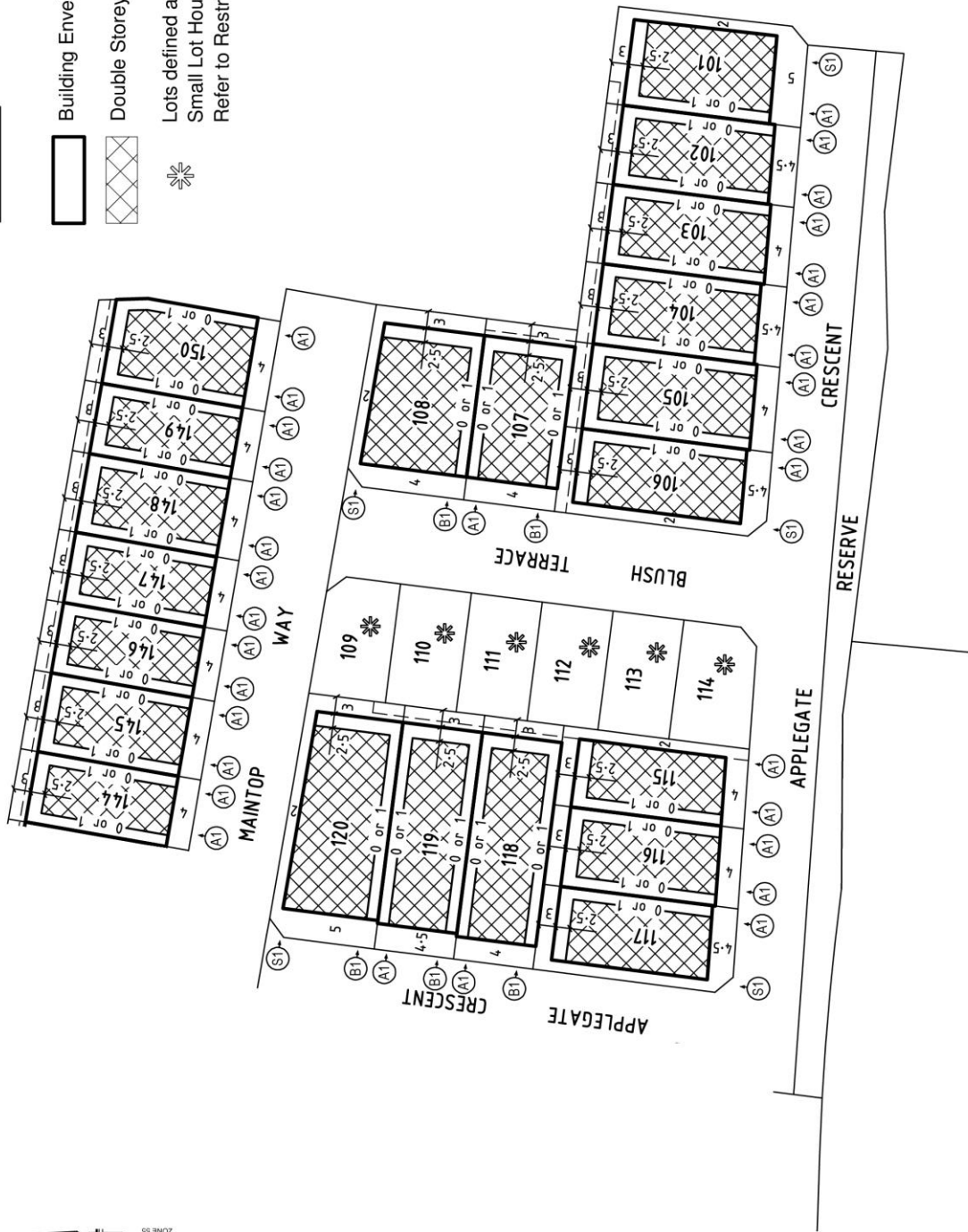

LEGEND

Building Envelope

Double Storey Zone

✱ Lots defined as Type A Lots under Small Lot Housing Code Refer to Restriction No. 2 in PS 732577J

SUB-STATION RESERVE

